

EV Battery Manufacturing Proximity Sensor E2EW-EV Series

DC 2-wire/DC 3-wire

Copper- and zinc-free ^{*3} EV battery manufacturing proximity sensor



- Equivalent sensing distances for both iron and aluminum ^{*1}
- Enables common design for lines with both iron and aluminum ^{*1}
- The exceptional sensing range, which means fewer false detections and thereby fewer unexpected stoppages. ^{*1}
- Durable full metal body to reduce unexpected stoppages
- 2-output (NO+NC) models and models with IO-Link ^{*1} are also available.
- Laser printed information (sensing distance on the sensor head and model on the cable) ^{*2} can be reducing errors during sensor replacement.
- UL certification (UL60947-5-2) and CSA certification (CSA C22.2 UL60947-5-2-14) ^{*2}

*1. PREMIUM Models only.

*2. DC 2-wire, M8-size models are excluded.



For the most recent information on models that have been certified for safety standards, refer to your OMRON website.



Be sure to read *Safety Precautions* on page 10.

Features

Proximity sensors free from copper and zinc affecting battery performance ^{*3} help build production lines for safe and reliable EV batteries

Devices enclosed in a housing that does not contain copper or zinc are required to ensure the safety and reliability of EV batteries. Clamping nuts and washers provided as accessories with E2EW-EV ^{*4} Proximity Sensors are also made of SUS and free from copper and zinc, allowing them to be reliably used in EV battery manufacturing processes.

BEFORE

It is impossible to ensure the safety and reliability of EV batteries manufactured by using devices that contain copper or zinc.

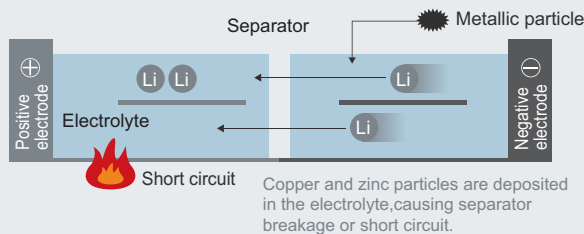

- The use of devices that do not contain metallic materials affecting battery performance and reliability or that meet the inhouse content percentage standard needs to be considered. It will take over one month to select these devices.

AFTER

A wide range of products that are free from specific metals ^{*3} and enclosed in a SUS contribute to the construction of production lines for safe and reliable EV batteries.



- Our products that do not contain specific metals ^{*3} eliminate the need for the examination of metal content, saving time and effort.

*3. Metals used for a housing contain 5% or less of specific substances. (Based on our investigation.)

*4. Use the XS2Z-31 Spatter Protection Cover because the connector of pre-wired connector models (-M1TJ/-M1J/-M1TGJ) is plated with zinc. For details, refer to XS2 on your local OMRON website.

E2EW-EV Series

Model Number Legend

E2EW - X (1) (2) (3) (4) (5) - (6) - (7) EV (8)

No.	Type	Code	Meaning	Remarks
(1)	Sensing distance	Number	Sensing distance (Unit: mm)	
(2)	Output configuration	B	DC 3-wire PNP open collector	Whether the D model has polarity is defined by number (7).
		C	DC 3-wire NPN open collector	
		D	DC 2-wire polarity/no polarity	
(3)	Operation mode	1	Normally open (NO)	
		2	Normally closed (NC)	
		3	Normally open, Normally closed (NO+NC)	
(4)	IO-Link baud rate	Blank	Non IO-Link compliant	
		D	COM2 (38.4kbps)	
		T	COM3 (230.4kbps)	
(5)	Size	8	M8	
		12	M12	
		18	M18	
		30	M30	
(6)	Connection method	Blank	Pre-wired Models	
		M1TGJ	M12 Pre-wired Smartclick Connector Models DC 2-wire	
		M1TJ	M12 Pre-wired Smartclick Connector Models DC 3-wire	
(7)	DC 2-wire polarity	Blank	Polarity	
		T	No polarity	
(8)	Cable length	Number M	Cable length	





Note: The purpose of this model number legend is to provide understanding of the meaning of specifications from the model number.

Ordering Information

BASIC Model

Double distance model

DC 2-wire [Refer to *Ratings and Specifications* on page 4, *Dimensions* on page 13.]



Size (Sensing distance)	Body size	Connection method	Polarity	Model	
				Operation mode: NO	
M8 (2 mm)		Pre-wired (2 m)	Yes	E2EW-X2D18-EV 2M	
		M12 Pre-wired Smartclick Connector (0.3 m)	Yes	E2EW-X2D18-M1TGJ-EV 0.3M	
M12 (3 mm)		Pre-wired (2 m)	Yes	E2EW-X3D112-EV 2M	
		M12 Pre-wired Smartclick Connector (0.3 m)	Yes	E2EW-X3D112-M1TGJ-EV 0.3M	
			No	E2EW-X3D112-M1TGJ-TEV 0.3M	
M18 (7 mm)		Pre-wired (2 m)	Yes	E2EW-X7D118-EV 2M	
		M12 Pre-wired Smartclick Connector (0.3 m)	Yes	E2EW-X7D118-M1TGJ-EV 0.3M	
			No	E2EW-X7D118-M1TGJ-TEV 0.3M	
M30 (12 mm)		Pre-wired (2 m)	Yes	E2EW-X12D130-EV 2M	
		M12 Pre-wired Smartclick Connector (0.3 m)	Yes	E2EW-X12D130-M1TGJ-EV 0.3M	
			No	E2EW-X12D130-M1TGJ-TEV 0.3M	

- Note:** 1. When embedding the Proximity Sensor in metal, refer to *Influence of Surrounding Metal* on page 11.
 2. IO-Link is not supported for BASIC Model.
 3. M8-size models have some different specifications (e.g., indicator, information printed on sensor head, body size) from M12, M18, or M30-size models.
 Refer to *Ratings and Specifications* and *Dimensions* for details and differences.

PREMIUM Model

Triple distance model

DC 3-wire [Refer to *Ratings and Specifications* on page 5, *Dimensions* on page 14.]

Size (Sensing distance)	Body size	Connection method	Operation mode	Model	
				PNP	NPN
M12 (6 mm)		Pre-wired (2 m)	NO	E2EW-X6B1T12-EV 2M	E2EW-X6C112-EV 2M
			NO+NC	E2EW-X6B3T12-EV 2M	---
		M12 Pre-wired Smartclick Connector (0.3 m)	NO	E2EW-X6B1T12-M1TJ-EV 0.3M	E2EW-X6C112-M1TJ-EV 0.3M
			NO+NC	E2EW-X6B3T12-M1TJ-EV 0.3M	---
M18 (10 mm)		Pre-wired (2 m)	NO	E2EW-X10B1T18-EV 2M	E2EW-X10C118-EV 2M
			NO+NC	E2EW-X10B3T18-EV 2M	---
		M12 Pre-wired Smartclick Connector (0.3 m)	NO	E2EW-X10B1T18-M1TJ-EV 0.3M	E2EW-X10C118-M1TJ-EV 0.3M
			NO+NC	E2EW-X10B3T18-M1TJ-EV 0.3M	---

- Note:** 1. When embedding the Proximity Sensor in metal, refer to *Influence of Surrounding Metal* on page 11.
 2. Models in are equipped with IO-Link (COM3).
 Operation mode NO can be changed to NC via IO-Link communications.
 3. IO-Link is not supported for all types of NPN outputs.

Accessories (Sold Separately)

Nut Sets

A Nut Set is included with the Sensor. Order a Nut Set when required, e.g., if you lose the nuts.

Model	Applicable Sensors	Applicable Sensor diameter	Set contents
Y92E-NWM12-E2EW-EV	E2EW-EV Series	M12	Clamping nuts (Stainless steel: SUS303): 2 Toothed washer (Stainless steel: SUS304): 1
Y92E-NWM18-E2EW-EV		M18	
Y92E-NWM30-E2EW-EV		M30	

Sensor I/O Connectors (Sold Separately)

For details of the connector, refer to XS5 Series on page 15.

E2EW-EV Series

Ratings and Specifications

BASIC Model

Double distance model

DC 2-wire

Item	Size Model	M8	M12	M18	M30
		E2EW-X2D18-EV	E2EW-X3D112-(T)EV	E2EW-X7D118-(T)EV	E2EW-X12D130-(T)EV
Sensing distance		2 mm ±10%	3 mm ±10%	7 mm ±10%	12 mm ±10%
Setting distance		0 to 1.4 mm	0 to 2.1 mm	0 to 4.9 mm	0 to 8.4 mm
Differential travel		15% max. of sensing distance			
Detectable object		Ferrous metals and non-ferrous metals (The sensing distance depends on the material of the sensing object. Refer to <i>Engineering Data</i> on page 6.)			
Standard sensing object (Iron)		12 × 12 × 1 mm	21 × 21 × 1 mm	30 × 30 × 1 mm	54 × 54 × 1 mm
Response frequency *1		200 Hz	80 Hz	90 Hz	50 Hz
Power supply voltage		10 to 30 VDC (including 10% ripple (p-p)), Class 2			
Leakage current		0.8 mA max.			
Output configuration		D1 models: Polarity D1-T models: No polarity			
Operation mode		NO (Normally open)			
Control output	Load current	3 to 100 mA			
	Residual voltage	Polarity: 3 V max. (Load current: 100 mA, Cable length: 2 m) No polarity: 5 V max. (Load current: 100 mA, Cable length: 2 m)			
Indicator		Operation indicator (red) and setting indicator (green)	Operation indicator (orange) and setting indicator (green)		
Protection circuits		Surge suppressor, Output short-circuit protection			
Ambient temperature range		Operating: -10 to 70 °C, Storage: -25 to 70 °C (with no icing or condensation)	Operating: 0 to 85 °C, Storage: -15 to 85 °C (with no icing or condensation) *2		
Ambient humidity range		Operating/Storage: 35% to 95% (with no condensation)			
Temperature influence		±20% max. of sensing distance at 23 °C in the temperature range of -10 to 70 °C	±20% max. of sensing distance at 23 °C in the temperature range of 0 to 85 °C		
Voltage influence		±1% max. of sensing distance at rated voltage in the rated voltage ±15% range	±1.5% max. of sensing distance at rated voltage in the rated voltage ±15% range		
Insulation resistance		50 MΩ min. (at 500 VDC) between current-carrying parts and case			
Dielectric strength		1,000 VAC, 50/60 Hz for 1 minute between current-carrying parts and case			
Vibration resistance (destruction)		10 to 55 Hz, 1.5-mm double amplitude for 2 hours each in X, Y, and Z directions			
Shock resistance (destruction)		500 m/s ² 10 times each in X, Y, and Z directions	1,000 m/s ² 10 times each in X, Y, and Z directions		
Degree of protection		IEC 60529: IP67			
Connection method		Pre-wired Models (Standard cable length: 2 m), Pre-wired Connector Models (Standard cable length: 0.3 m)			
Weight (packed state)	Pre-wired	Approx. 105 g	Approx. 140 g	Approx. 165 g	Approx. 225 g
	M12 Pre-wired Smartclick Connector	Approx. 65 g	Approx. 70 g	Approx. 100 g	Approx. 160 g
Materials	Case	Stainless steel (SUS303)	Stainless steel (SUS303Cu)		
	Sensing surface	Stainless steel (SUS303)	Stainless steel (SUS303Cu)		
	Sensing surface (Thickness)	0.2 mm	0.4 mm	0.4 mm	0.5 mm
	Clamping nuts	Stainless steel (SUS303)			
	Toothed washers	Stainless steel (SUS304)			
	Cable	Vinyl chloride (PVC)			
Accessories		Instruction manual, Clamping nuts, Toothed washer			

*1. The response frequency is an average value. Measurement conditions are as follows: standard sensing object, a distance of twice the standard sensing object, and a set distance of half the sensing distance.

*2. UL temperature rating is between 0 °C to 60 °C.

PREMIUM Model

Triple distance model

DC 3-wire

Item	Size Model	M12	M18
		E2EW-X6□12-EV	E2EW-X10□18-EV
Sensing distance		6 mm ±10%	10 mm ±10%
Setting distance		0 to 4.2 mm	0 to 7.0 mm
Differential travel		15% max. of sensing distance	
Detectable object		Ferrous metals and non-ferrous metals (The sensing distance depends on the material of the sensing object. Refer to <i>Engineering Data</i> on page 6.)	
Standard sensing object (Iron)		18 × 18 × 1 mm	30 × 30 × 1 mm
Response frequency *1		30 Hz	20 Hz
Power supply voltage		10 to 30 VDC (including 10% ripple (p-p)), Class 2	
Current consumption		720 mW max. (Current consumption: 30 mA max. at power supply voltage of 24 V)	
Output configuration		B□ Models: PNP open collector, C□ Models: NPN open collector	
Operation mode		1-output models (B1, C1): NO (Normally open), 2-output models (B3): NO+NC (Normally open, Normally closed)	
Control output	Load current	1-output models (B1, C1): 10 to 30 VDC, Class 2, 200 mA max. 2-output models (B3): 10 to 30 VDC, Class 2, 100 mA max.	
	Residual voltage	1-output models (B1, C1): 2 V max. (Load current: 200 mA, Cable length: 2 m) 2-output models (B3): 2 V max. (Load current: 100 mA, Cable length: 2 m)	
Indicator		In the Standard I/O mode (SIO mode): Operation indicator (orange, lit) and communication indicator (green, not lit) In the IO-Link communication mode (COM mode): Operation indicator (orange, lit) and communication indicator (green, blinking at 1 s intervals)	
Protection circuits		Power supply reverse polarity protection, Surge suppressor, Output short-circuit protection, Output reverse polarity protection	
Ambient temperature range		Operating: 0 to 85 °C, Storage: -15 to 85 °C (with no icing or condensation) *3	
Ambient humidity range		Operating: 0 to 85 °C, Storage: -15 to 85 °C (with no icing or condensation) *3	
Temperature influence		±20% max. of sensing distance at 23 °C in the temperature range of 0 to 85 °C	
Voltage influence		±20% max. of sensing distance at 23 °C in the temperature range of 0 to 85 °C	
Insulation resistance		±20% max. of sensing distance at 23 °C in the temperature range of 0 to 85 °C	
Dielectric strength		1,000 VAC, 50/60 Hz for 1 minute between current-carrying parts and case	
Vibration resistance (destruction)		10 to 55 Hz, 1.5-mm double amplitude for 2 hours each in X, Y, and Z directions	
Shock resistance (destruction)		10 to 55 Hz, 1.5-mm double amplitude for 2 hours each in X, Y, and Z directions	
Degree of protection		IEC 60529: IP67	
Connection method		Pre-wired Models (Standard cable length: 2 m), Pre-wired Connector Models (Standard cable length: 0.3 m)	
Weight (packed state)	Pre-wired	Approx. 140 g	Approx. 165 g
	M12 Pre-wired Smartclick Connector	Approx. 70 g	Approx. 100 g
Materials	Case	Stainless steel (SUS303Cu)	
	Sensing surface	Stainless steel (SUS303Cu)	
	Sensing surface (Thickness)	0.4 mm	0.4 mm
	Clamping nuts	Stainless steel (SUS303)	
	Toothed washers	Stainless steel (SUS304)	
	Cable	Vinyl chloride (PVC)	
Main IO-Link functions *2		Operation mode switching between NO and NC, self diagnosis enabling, excessive proximity judgment distance selecting, timer function of the control output and timer time selecting, instability output (IO-Link mode) ON delay timer time selecting function, monitor output, operating hours read-out, readout of the sensor internal temperature, and initial reset	
IO-Link Communication specifications *2	IO-Link specification	Ver.1.1	
	Baud rate	COM3 (230.4 kbps)	
	Data length	PD size: 2 bytes, OD size: 1 byte (M-sequence type: TYPE_2_2)	
	Minimum cycle time	COM3: 1.0 ms	
Accessories		Instruction manual, Clamping nuts, Toothed washer	

*1. The response frequency is an average value.

*2. IO-Link is not supported for all types of NPN outputs.

*3. UL temperature rating is between 0 °C to 60 °C.

E2EW-EV Series

Engineering Data (Reference Value)

Sensing Area

BASIC Model

DC 2-wire

Double distance model

Sensing object: iron

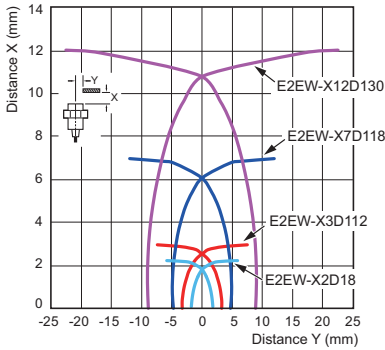

PREMIUM Model

DC 3-wire

Triple distance model

Sensing object: iron

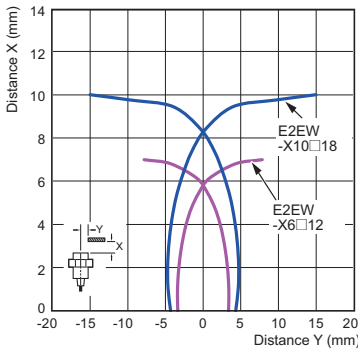

Sensing object: Aluminum

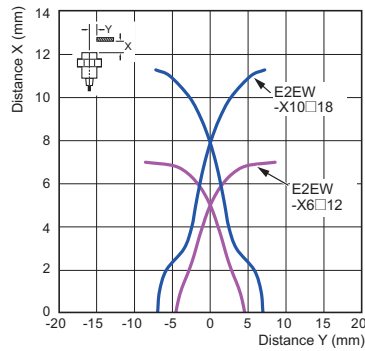

Monitor Output vs. Sensing Distance

PREMIUM Model

DC 3-wire

Triple distance model

Size: M12

E2EW-X6□12

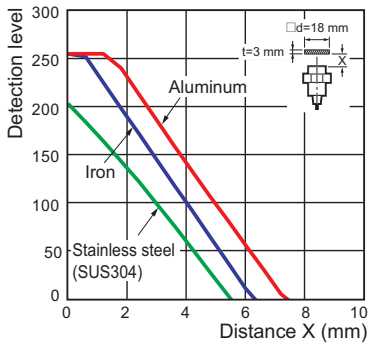

Size: M18

E2EW-X10□18

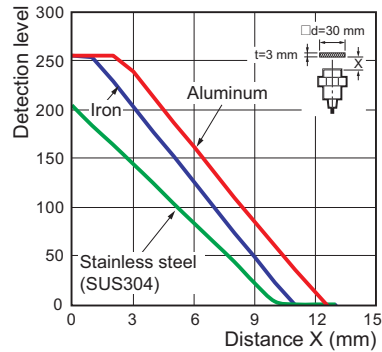

Influence of Sensing Object Size and Material

BASIC Model

DC 2-wire Double distance model

Size: M8
E2EW-X2D18

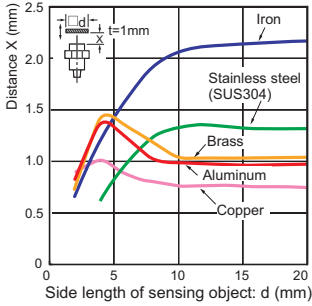

PREMIUM Model

DC 3-wire Triple distance model

Size: M12
E2EW-X6□12

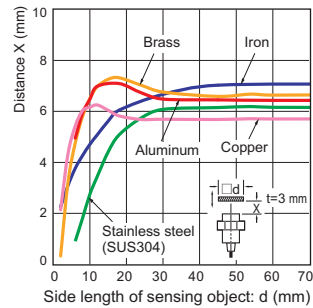

Size: M12
E2EW-X3D112

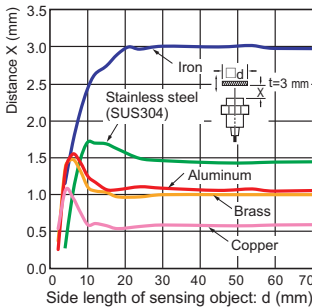

Size: M18
E2EW-X10□18

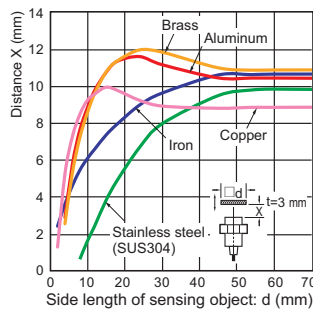

Size: M18
E2EW-X7D118

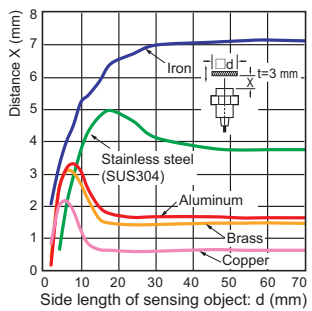

Size: M30
E2EW-X12D130

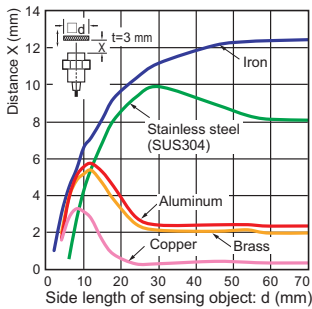

Influence of Sensing Object Thickness and Material

BASIC Model

DC 2-wire Double distance model

Size: M12
E2EW-X3D112

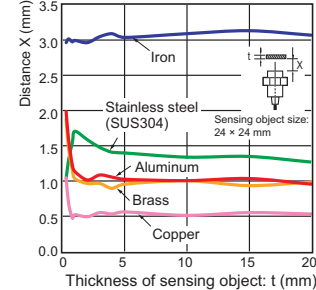

Size: M18
E2EW-X7D118

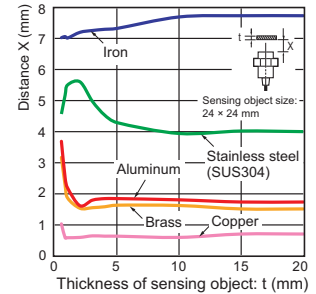

Size: M30
E2EW-X12D130

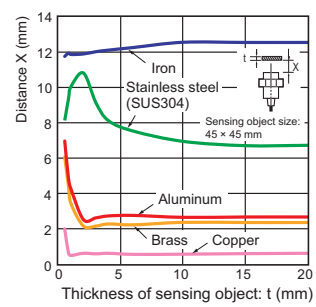

PREMIUM Model

DC 3-wire Triple distance model

Size: M12
E2EW-X6□12

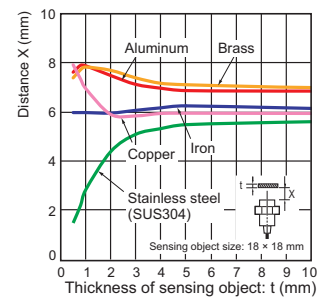

Size: M18
E2EW-X10□18

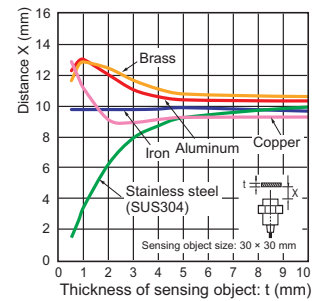

E2EW-EV Series

I/O Circuit Diagrams/Timing charts

DC 2-wire

BASIC Models

Operation mode	Model	Timing chart	Output circuit
NO	E2EW-X□D1□	<p>Setting indicator (green) OFF Operation indicator (orange) (red) *1 OFF Control output ON</p>	<p>Note 1. The load can be connected to either the +V or 0 V side. 2. Pins 2 and 3 of the Pre-wired Smartclick Connector type are not used.</p>
	E2EW-X□D1□-T	<p>*1. Only M8-size models have a red indicator.</p>	<p>Note 1. The load can be connected to either the +V or 0 V side. 2. There is no polarity. Therefore, no need to be concerned about the polarity of pins 3 and 4. Pins 1 and 2 of the Pre-wired Smartclick Connector type are not used.</p>

DC 3-wire

PNP output (PREMIUM Model) [Refer to Timing Chart on page 9]

Operation mode	Model	Output circuit	
		Standard I/O mode (SIO mode) When using as a general	IO-Link Communication mode (COM mode) When using the Sensor connected to IO-Link Master Unit
NO	E2EW-X□B1		
NO+NC	E2EW-X□B3		

In the IO-Link mode, the cord between the IO-Link master and sensor must have a length of 20 m or less.

NPN output (PREMIUM Model)

Operation mode	Model	Timing chart	Output circuit
NO	E2EW-X□C1	<p>ON Operation indicator OFF (orange) ON OFF Control output</p>	

Connector Pin Arrangement

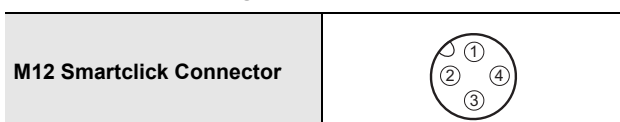

DC 3-wire

PNP output (PREMIUM Model)

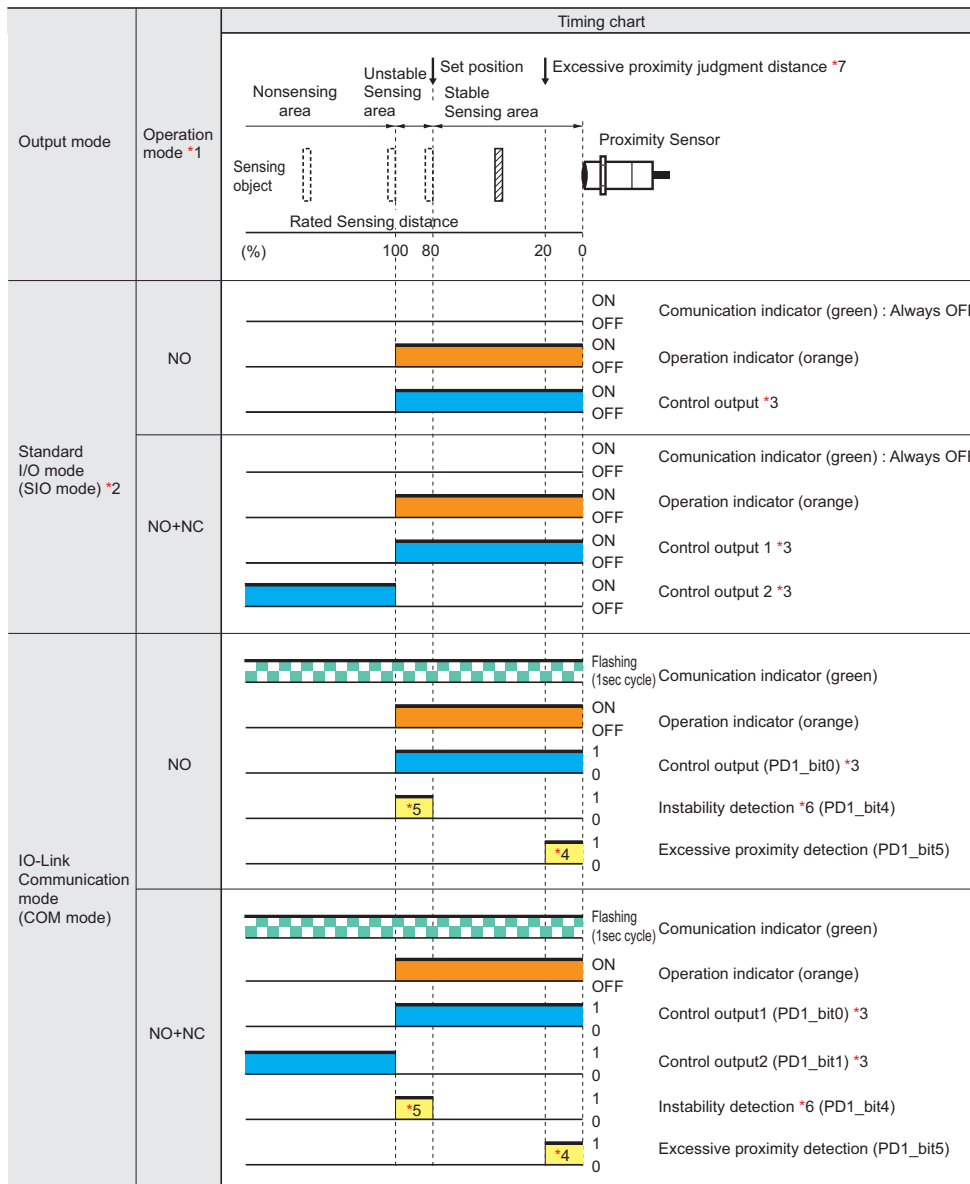

Please contact your OMRON sales representative regarding assignment of data.

- *1. For models with IO-Link, the operation mode can be changed by the IO-Link communications.
- *2. If using a model with IO-Link as a general sensor or using a model without IO-Link, it operates in the standard I/O mode (SIO mode).
- *3. The timer function of the control output can be set up by the IO-Link communications. (It is able to select ON delay, OFF delay, one-shot, or ONOFF delay function and select a timer time of 1 to 16,383ms (T).)

ON delay		OFF delay		One shot		ONOFF delay	
Sensing object	Present	Sensing object	Present	Sensing object	Present	Sensing object	Present
	Not present		Not present		Not present		Not present
NO	ON 1	NO	ON 1	NO	ON 1	NO	ON 1
	OFF 0		OFF 0		OFF 0		OFF 0
NC	ON 1	NC	ON 1	NC	ON 1	NC	ON 1
	OFF 0		OFF 0		OFF 0		OFF 0

- *4. The excessive proximity diagnosis function can be selected by the IO-Link communications.
- *5. The instability detection diagnosis can be selected by the IO-Link communications.
- *6. The judgment time for the instability detection diagnosis can be selected by the IO-Link communications. (For the ON delay timer function, the setting can be selected from 0 (invalid), 10, 50, 100, 300, 500, or 1000 ms.)
- *7. The judgment distance of the excessive proximity diagnosis function can be selected by the IO-Link communications. (The distance can be selected as a combination of the material of the object detected, such as iron, aluminum, or SUS and the judgment distance of approximately 10, 20, or 30%. However, it is not allowed to select a combination of aluminum and 10%.)

Please contact your OMRON sales representative regarding the IO-Link setup file (IODD file)

Safety Precautions

Be sure to read the precautions for all models in the website at: <http://www.ia.omron.com/>.

Warning Indications

⚠ WARNING	Warning level Indicates a potentially hazardous situation which, if not avoided, will result in minor or moderate injury, or may result in serious injury or death. Additionally there may be significant property damage.
Precautions for Safe Use	Supplementary comments on what to do or avoid doing, to use the product safely.
Precautions for Correct Use	Supplementary comments on what to do or avoid doing, to prevent failure to operate, malfunction or undesirable effect on product performance.

Meaning of Product Safety Symbols

	General prohibition Indicates the instructions of unspecified prohibited action.
	Caution, explosion Indicates the possibility of explosion under specific conditions.

⚠ WARNING

This product is not designed or rated for ensuring safety of persons either directly or indirectly. Do not use it for such purposes.

Otherwise, explosion may result. Never use the product with an AC power supply.

Precautions for Safe Use

The following precautions must be observed to ensure safe operation.

1. Do not use the product in environments subject to flammable or explosive gases.
2. Do not attempt to disassemble, repair, or modify the product.
3. Do not use a voltage that exceeds the rated operating voltage range.
Applying a voltage that is higher than the operating voltage range may result in explosion or fire.
4. Be sure that the power supply polarity and other wiring is correct. Incorrect wiring may cause explosion or fire.
5. If the power supply is connected directly without a load, the internal elements may explode or burn.
6. Dispose of the product according to applicable regulations (laws).

Precautions for Correct Use

Do not use the product in any atmosphere or environment that exceeds the ratings.

Operating Environment

1. Do not install the Sensor in the following locations.
 - (1) Outdoor locations directly subject to sunlight, rain, snow, water droplets, or oil.
 - (2) Locations subject to atmospheres with chemical vapors, in particular solvents and acids.
 - (3) Locations subject to corrosive gases.
2. The Sensor may malfunction if used near ultrasonic cleaning equipment, high-frequency equipment, transceivers, cellular phones, inverters, or other devices that generate a high-frequency electric field. Please refer to the Precautions for Correct Use on the OMRON website (www.ia.omron.com) for typical measures.
3. Laying the Proximity Sensor wiring in the same conduit or duct as high-voltage wires or power lines may result in incorrect operation and damage due to induction. Wire the Sensor using a separate conduit or independent conduit.
4. Never use thinner or other solvents. Otherwise, the Sensor surface may be dissolved.
5. When turning on the power by influence of temperature environment, an output mis-pulse sometimes occurs. After the sensor has passed for 300 msec after turning on, please use in the stable state.
6. The sensor is adjusted with a high degree of accuracy, so do not use in the environment with sudden temperature change.
7. Operation check is performed using an OMRON's IO-Link master. If using an IO-Link master from another company, perform the operation check in advance. (Models with IO-Link only.)
8. When connecting non IO-Link compliant models to the IO-Link master, use the SIO mode.
9. In the IO-Link mode, the cord between the IO-Link master and sensor must have a length of 20 m or less. (Models with IO-Link only.)
10. The Sensor cannot be used embedded in where pressure is constantly applied to the sensing surface, such as hydraulic cylinders and hydraulic valves.

AND Connection of Proximity Sensors (DC 2-wire)

Two or more sensors cannot be connected in series on the AND circuit. Use them via a relay as shown on the figure.

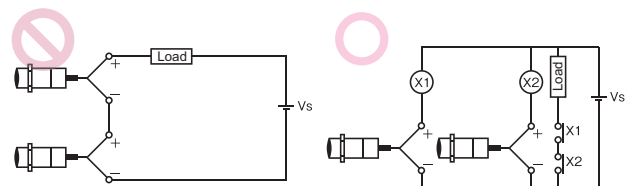

OR Wiring of Proximity Sensors (DC 2-wire)

As a general principle, two or more sensors cannot be used in parallel on the OR circuit. It is possible only when sensors do not operate simultaneously and loads do not need to be maintained. When loads need to be maintained, use the sensors via a relay as shown on the figure.

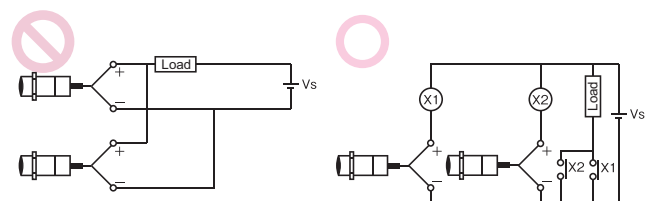

Design

Influence of Surrounding Metal

When mounting the Proximity Sensor, ensure that the minimum distances given in the following table are maintained.
 If you use a nut, only use the provided nut. And ensure that the minimum distances between the sensing surface and nut is bigger than the "L" given in the following table.
 Other non-ferrous metals affect sensor's performance in the same way as aluminum. Perform the operation check in advance.

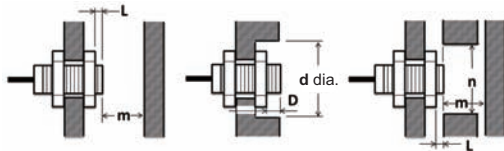

(Unit: mm)

Mounting panel material: Iron

Models	Model	L	d	D	m	n
Triple distance model	E2EW-X6□12	4	30	4	24	36
	E2EW-X10□18	2	54	2	30	54
Double distance model	E2EW-X2□8	0	8	0	8	30
	E2EW-X3□12	0	12	0	12	40
	E2EW-X7□18	0	18	0	28	60
	E2EW-X12□30	0	30	0	48	100

Mounting panel material: Aluminum

Models	Model	L	d	D	m	n
Triple distance model	E2EW-X6□12	12	70	12	24	70
	E2EW-X10□18	12	80	12	30	80
Double distance model	E2EW-X2□8	10	50	10	8	50
	E2EW-X3□12	12	70	12	12	70
	E2EW-X7□18	12	80	12	28	80
	E2EW-X12□30	16	120	16	48	120

When the Proximity Sensor is mounted in metal, ensure that the minimum distances given in the following table are maintained.

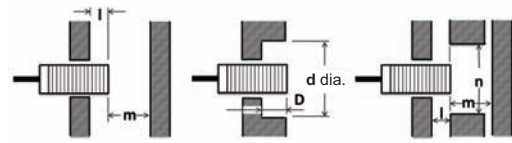

(Unit: mm)

Embedded material: Iron

Models	Model	l	d	D	m	n
Triple distance model	E2EW-X6□12	0 *1	12 *1	0 *1	24	36
	E2EW-X10□18	0	18	0	30	54
Double distance model	E2EW-X2□8	0	8	0	8	30
	E2EW-X3□12	0	12	0	12	40
	E2EW-X7□18	0	18	0	28	60
	E2EW-X12□30	0	30	0	48	100

*1. If the thickness of the mounting bracket (t) is less than 10 mm, be sure to install the Sensor so that $l \geq 2$, $d \text{ (dia.)} \geq 30$, and $D \geq 2$.

Embedded material: Aluminum

Models	Model	l	d	D	m	n
Triple distance model	E2EW-X6□12	12	70	12	24	70
	E2EW-X10□18	12	80	12	30	80
Double distance model	E2EW-X2□8	10	50	10	8	50
	E2EW-X3□12	12	70	12	12	70
	E2EW-X7□18	12	80	12	28	80
	E2EW-X12□30	16	120	16	48	120

Mutual Interference

When installing two or more Proximity Sensors face-to-face or side-by-side, ensure that the minimum distances given in the following table are maintained.

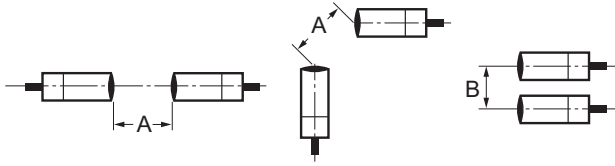

(Unit: mm)

Models	Model	Item	
		A	B
Triple distance model	E2EW-X6□12	45	40
	E2EW-X10□18	80	60
	E2EW-X20□30	135	110
Double distance model	E2EW-X2□8	35	35
	E2EW-X3□12	40	35
	E2EW-X7□18	65	60
	E2EW-X12□30	110	100

Chips from Cutting Aluminum

Normally, chips from cutting aluminum will not cause a detection signal to be output even if it adheres to or accumulates on the detection surface. In the following cases, however, a detection signal may be output.

Remove the cutting chips in these cases.

1. If $d \geq 2/3D$ at the center of the detection surface where d is the cutting chip size and D is the detection surface size

(Unit: mm)

Model	Dimension	D
E2EW-X□8		6
E2EW-X□12		10
E2EW-X□18		16
E2EW-X□30		28

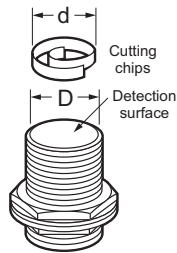

2. If the cutting chips are pressed down

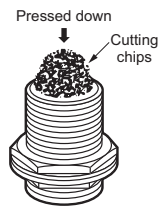

Mounting

Tightening Force

Do not tighten the nut with excessive force.

A washer must be used with the nut.

The tightening force must be the same or less than the figures in the following table.



Triple distance model

(Unit: N·m)

Size	Torque
M12	20
M18	70

Double distance model

(Unit: N·m)

Size	Torque
M8	9
M12	30
M18	70
M30	180

Note: When mounting the Proximity Sensor, only use the provided nut. Do not use set screws. The Sensor may malfunction.

Dimensions

Sensors

BASIC Model

DC 2-wire

Double distance model

Pre-wired Model



Product photo: M12-size model

Pre-wired Connector Model



Product photo: M12-size model

E2EW-X2D18-EV

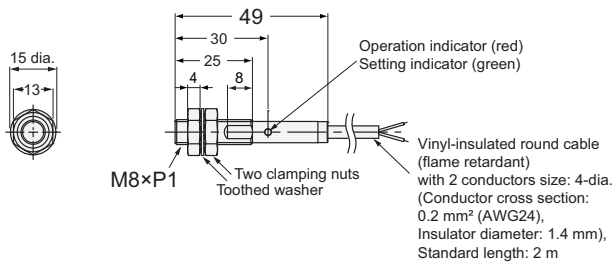

E2EW-X2D18-M1TGJ-EV

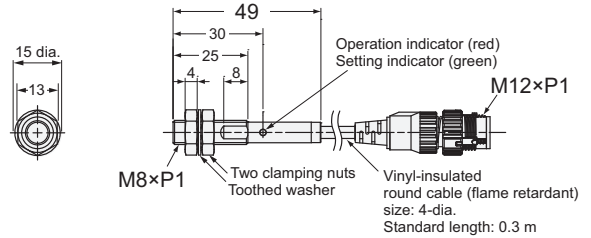

E2EW-X3D112-EV

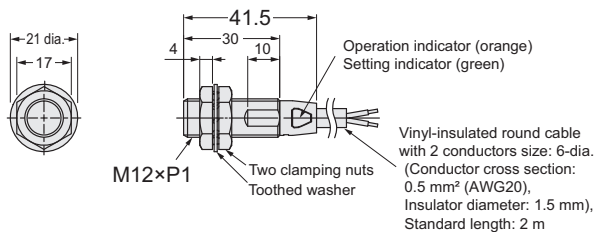

E2EW-X3D112-M1TGJ-(T)EV

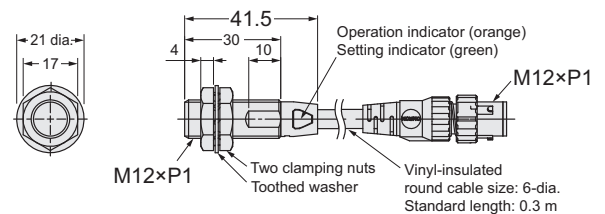

E2EW-X7D118-EV

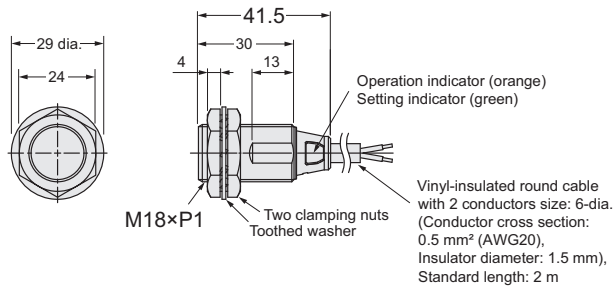

E2EW-X7D118-M1TGJ-(T)EV

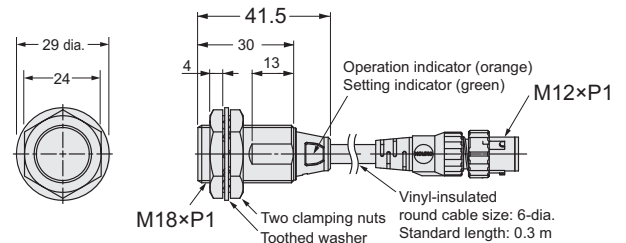

E2EW-X12D130-EV

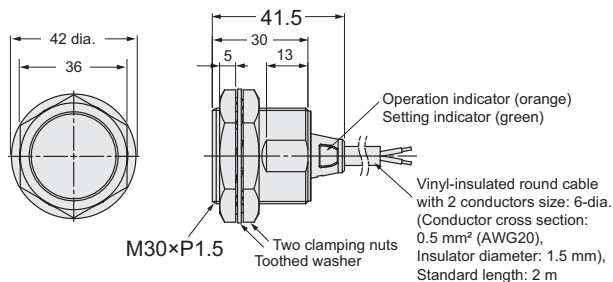

E2EW-X12D130-M1TGJ-(T)EV

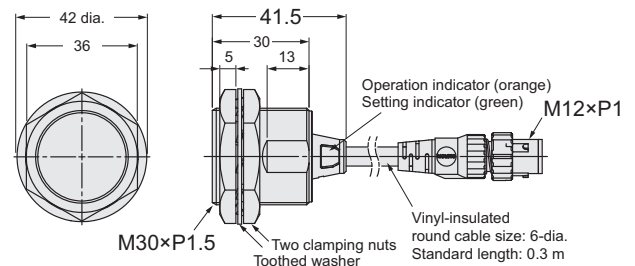

Mounting Hole Dimensions

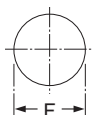

Dimensions	F (mm)
M8	8.5 dia. $^{+0.5}_0$
M12	12.5 dia. $^{+0.5}_0$
M18	18.5 dia. $^{+0.5}_0$
M30	30.5 dia. $^{+0.5}_0$

Angle R of the Bending Wire

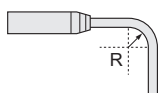

Dimensions	R (mm)
M8	12
M12	18
M18	
M30	

E2EW-EV Series

Dimensions

(Unit: mm)

Tolerance class IT16 applies to dimensions in this data sheet unless otherwise specified.

Sensors

PREMIUM Model DC 3-wire

Triple distance model

Pre-wired Model



Product photo: M12-size model

Pre-wired Connector Model



Product photo: M12-size model

E2EW-X6□12-EV

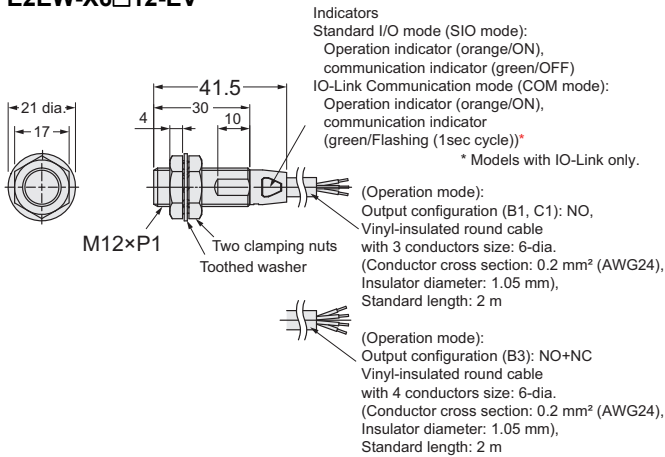

E2EW-X6□12-M1TJ-EV

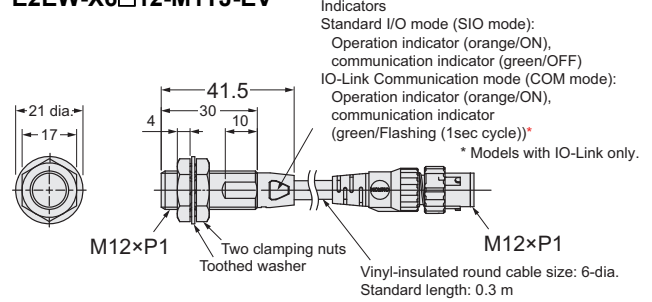

E2EW-X10□18-EV

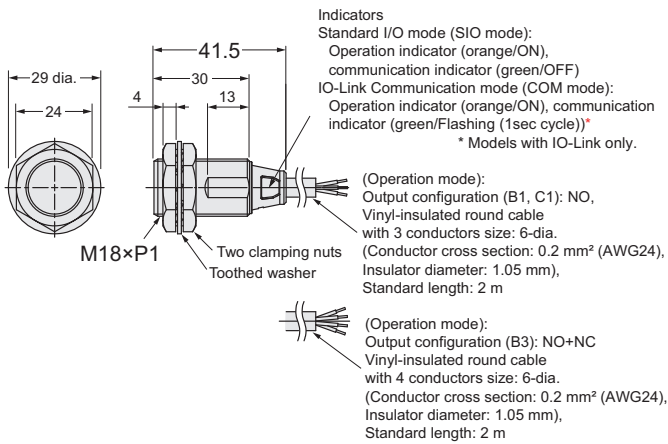

E2EW-X10□18-M1TJ-EV

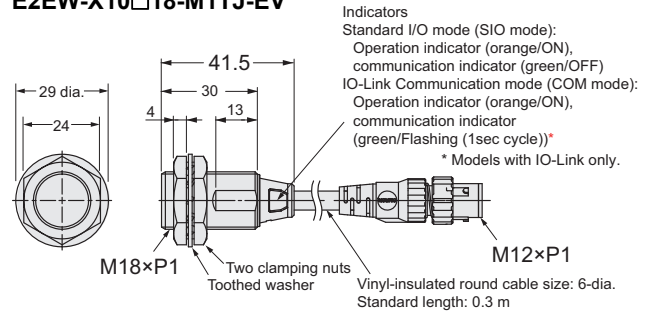

Mounting Hole Dimensions

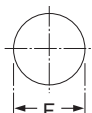

Dimensions	F (mm)
M12	12.5 dia. ^{+0.5} / ₀
M18	18.5 dia. ^{+0.5} / ₀

Angle R of the Bending Wire

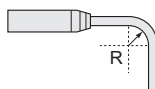

Dimensions	R (mm)
M12	18
M18	

XS5

Round Water-resistive Smartclick Connectors that Reduce Installation Work

- A newly developed lock mechanism that is compatible with round M12 connectors.
- Simply insert the Connectors, then turn them approximately 1/8 of a turn to lock.
- A positive click indicates locking.
- Spatter-resistant Cables are also available.
- IP67 degree of protection.
- UL approved products.

Note: For details, refer to XS5 on your OMRON website.





For the most recent information on models that have been certified for safety standards, refer to your OMRON website.

Ordering Information

Sensor I/O Connectors

A Sensor I/O Connector is not provided with the Sensor. It must be ordered separately as required.

Appearance	Cable Specification	Type	Cable diameter (mm)	Cable Connection Direction	Cable length (m)	Sensor I/O Connector model number	Applicable Proximity Sensor model number
M12 Smartclick Connector Straight type 	PVC robot cable	Sockets on One Cable End	6 dia.	Straight	1	XS5F-D421-C80-F	E2EW-EV (M12 Pre-wired Smartclick Connector)
					2	XS5F-D421-D80-F	
					3	XS5F-D421-E80-F	
					5	XS5F-D421-G80-F	
					10	XS5F-D421-J80-F	
				Right-angle	1	XS5F-D422-C80-F	
					2	XS5F-D422-D80-F	
					3	XS5F-D422-E80-F	
					5	XS5F-D422-G80-F	
					10	XS5F-D422-J80-F	
Right-angle type 	PVC robot cable	Socket and Plug on Cable Ends	6 dia.	Straight (Socket)/ Straight (Plug)	1	XS5W-D421-C81-F	
					2	XS5W-D421-D81-F	
					3	XS5W-D421-E81-F	
					5	XS5W-D421-G81-F	
					10	XS5W-D421-J81-F	
				Right-angle (Socket)/ Right-angle (Plug)	2	XS5W-D422-D81-F	
					5	XS5W-D422-G81-F	
				Straight (Socket)/ Right-angle (Plug)	2	XS5W-D423-D81-F	
					5	XS5W-D423-G81-F	
				Right-angle (Socket)/ Straight (Plug)	2	XS5W-D424-D81-F	
					5	XS5W-D424-G81-F	

XS5

Connections for Sensor I/O Connectors

DC 2-Wire

Proximity Sensor				Sensor I/O Connectors	
Type	Polarity	Operation mode	Model	Model	Connections *1
DC 2-Wire (M12 Pre-wired Smartclick Connector)	Yes	NO	E2EW-X□D1□-M1TGJ	XS5F-D42□-□80-F XS5W-D42□-□81-F	
	No	NO	E2EW-X□D1□-M1TGJ-T		

DC 3-Wire

Proximity Sensor				Sensor I/O Connectors	
Types	Output	Operation mode	Model	Model	Connections *1
DC 3-Wire (M12 Smartclick Connector)	PNP	NO	E2EW-X□B1□-M1TJ	XS5F-D42□-□80-F XS5W-D42□-□81-F	
		NO+NC	E2EW-X□B3□-M1TJ		
	NPN	NO	E2EW-X□C1□-M1TJ		

*1. If the XS5W Series Connector which has a socket and plug on the cable ends is connected to the Sensor, this part will be a plug.
Note: Different from Proximity Sensor wire colors.

Dimensions

Socket and Plug on Cable Ends XS5W

Wiring Diagram for 4 Cores

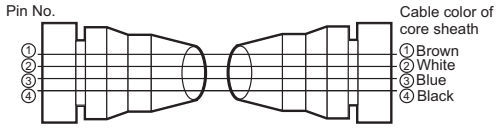

**Straight (Socket)/straight (Plug)
XS5W-D421-□81-F**

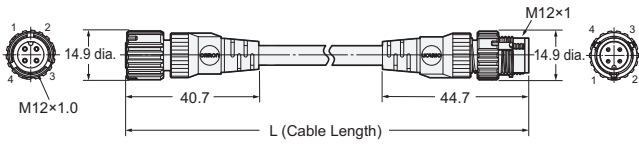

**Right-angle (Socket)/right-angle (Plug)
XS5W-D422-□81-F**

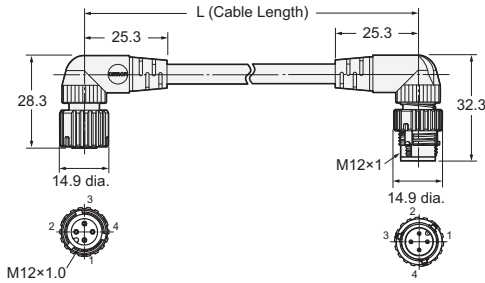

**Straight (Socket)/right-angle (Plug)
XS5W-D423-□81-F**

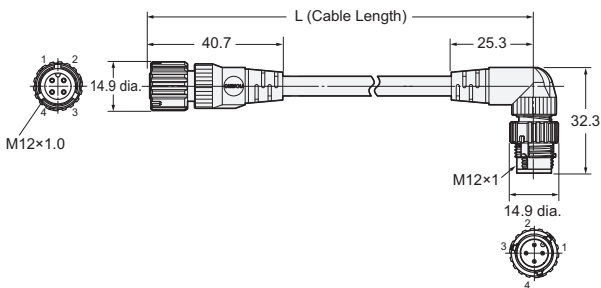

**Right-angle (Socket)/straight (Plug)
XS5W-D424-□81-F**

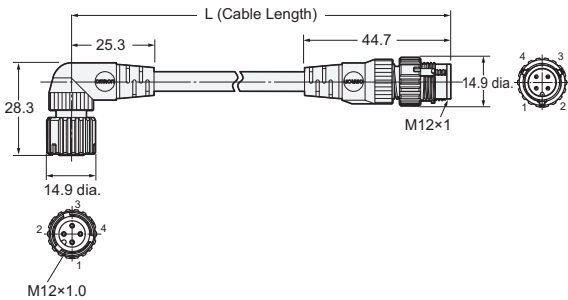

Sockets on One Cable End XS5F

Wiring Diagram for 4 Cores

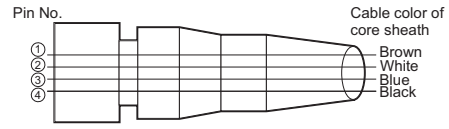

**Straight type
XS5F-D421-□80-F**

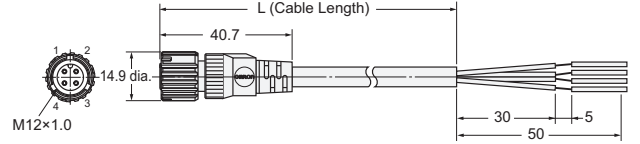

**Right-angle type
XS5F-D422-□80-F**

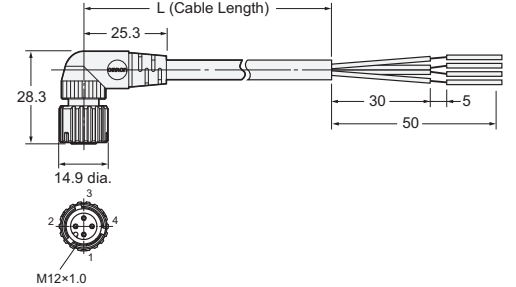

Terms and Conditions Agreement

Read and understand this catalog.

Please read and understand this catalog before purchasing the products. Please consult your OMRON representative if you have any questions or comments.

Warranties.

- (a) Exclusive Warranty. Omron's exclusive warranty is that the Products will be free from defects in materials and workmanship for a period of twelve months from the date of sale by Omron (or such other period expressed in writing by Omron). Omron disclaims all other warranties, express or implied.
- (b) Limitations. OMRON MAKES NO WARRANTY OR REPRESENTATION, EXPRESS OR IMPLIED, ABOUT NON-INFRINGEMENT, MERCHANTABILITY OR FITNESS FOR A PARTICULAR PURPOSE OF THE PRODUCTS. BUYER ACKNOWLEDGES THAT IT ALONE HAS DETERMINED THAT THE PRODUCTS WILL SUITABLY MEET THE REQUIREMENTS OF THEIR INTENDED USE.

Omron further disclaims all warranties and responsibility of any type for claims or expenses based on infringement by the Products or otherwise of any intellectual property right. (c) Buyer Remedy. Omron's sole obligation hereunder shall be, at Omron's election, to (i) replace (in the form originally shipped with Buyer responsible for labor charges for removal or replacement thereof) the non-complying Product, (ii) repair the non-complying Product, or (iii) repay or credit Buyer an amount equal to the purchase price of the non-complying Product; provided that in no event shall Omron be responsible for warranty, repair, indemnity or any other claims or expenses regarding the Products unless Omron's analysis confirms that the Products were properly handled, stored, installed and maintained and not subject to contamination, abuse, misuse or inappropriate modification. Return of any Products by Buyer must be approved in writing by Omron before shipment. Omron Companies shall not be liable for the suitability or unsuitability or the results from the use of Products in combination with any electrical or electronic components, circuits, system assemblies or any other materials or substances or environments. Any advice, recommendations or information given orally or in writing, are not to be construed as an amendment or addition to the above warranty.

See <http://www.omron.com/global/> or contact your Omron representative for published information.

Limitation on Liability; Etc.

OMRON COMPANIES SHALL NOT BE LIABLE FOR SPECIAL, INDIRECT, INCIDENTAL, OR CONSEQUENTIAL DAMAGES, LOSS OF PROFITS OR PRODUCTION OR COMMERCIAL LOSS IN ANY WAY CONNECTED WITH THE PRODUCTS, WHETHER SUCH CLAIM IS BASED IN CONTRACT, WARRANTY, NEGLIGENCE OR STRICT LIABILITY.

Further, in no event shall liability of Omron Companies exceed the individual price of the Product on which liability is asserted.

Suitability of Use.

Omron Companies shall not be responsible for conformity with any standards, codes or regulations which apply to the combination of the Product in the Buyer's application or use of the Product. At Buyer's request, Omron will provide applicable third party certification documents identifying ratings and limitations of use which apply to the Product. This information by itself is not sufficient for a complete determination of the suitability of the Product in combination with the end product, machine, system, or other application or use. Buyer shall be solely responsible for determining appropriateness of the particular Product with respect to Buyer's application, product or system. Buyer shall take application responsibility in all cases.

NEVER USE THE PRODUCT FOR AN APPLICATION INVOLVING SERIOUS RISK TO LIFE OR PROPERTY OR IN LARGE QUANTITIES WITHOUT ENSURING THAT THE SYSTEM AS A WHOLE HAS BEEN DESIGNED TO ADDRESS THE RISKS, AND THAT THE OMRON PRODUCT(S) IS PROPERLY RATED AND INSTALLED FOR THE INTENDED USE WITHIN THE OVERALL EQUIPMENT OR SYSTEM.

Programmable Products.

Omron Companies shall not be responsible for the user's programming of a programmable Product, or any consequence thereof.

Performance Data.

Data presented in Omron Company websites, catalogs and other materials is provided as a guide for the user in determining suitability and does not constitute a warranty. It may represent the result of Omron's test conditions, and the user must correlate it to actual application requirements. Actual performance is subject to the Omron's Warranty and Limitations of Liability.

Change in Specifications.

Product specifications and accessories may be changed at any time based on improvements and other reasons. It is our practice to change part numbers when published ratings or features are changed, or when significant construction changes are made. However, some specifications of the Product may be changed without any notice. When in doubt, special part numbers may be assigned to fix or establish key specifications for your application. Please consult with your Omron's representative at any time to confirm actual specifications of purchased Product.

Errors and Omissions.

Information presented by Omron Companies has been checked and is believed to be accurate; however, no responsibility is assumed for clerical, typographical or proofreading errors or omissions.

 Smartclick is a registered trademark of OMRON Corporation.

The product photographs and figures that are used in this catalog may vary somewhat from the actual products.

Note: Do not use this document to operate the Unit.

OMRON Corporation Industrial Automation Company

Kyoto, JAPAN

Contact : www.ia.omron.com

Regional Headquarters

OMRON EUROPE B.V.

Wegalaan 67-69, 2132 JD Hoofddorp
The Netherlands
Tel: (31) 2356-81-300 Fax: (31) 2356-81-388

OMRON ELECTRONICS LLC

2895 Greenspoint Parkway, Suite 200
Hoffman Estates, IL 60169 U.S.A.
Tel: (1) 847-843-7900 Fax: (1) 847-843-7787

OMRON ASIA PACIFIC PTE. LTD.

438B Alexandra Road, #08-01/02 Alexandra
Technopark, Singapore 119968
Tel: (65) 6835-3011 Fax: (65) 6835-3011

OMRON (CHINA) CO., LTD.

Room 2211, Bank of China Tower,
200 Yin Cheng Zhong Road,
PuDong New Area, Shanghai, 200120, China
Tel: (86) 21-6023-0333 Fax: (86) 21-5037-2388

Authorized Distributor:

©OMRON Corporation 2023 All Rights Reserved.
In the interest of product improvement,
specifications are subject to change without notice.

CSM_1_1

Cat. No. D127-E1-01 1023 (1023)