

スイッチング・パワーサプライ（240/480/960/2000Wタイプ）

S8VK-WA24024



商品概要

Switch Mode Power Supply, Capacity 240 W, Rated input voltage 200 to 240 VAC, Output voltage 24 V

販売状況

2026/06/03 00:00 情報更新

販売状況	販売中
機種区分	標準在庫機種
標準価格(税別)	¥ 44,000

推奨代替品の最新情報につきましては、当社Webサイト(www.fa.omron.co.jp)の「生産終了品/推奨代替品」をご覧ください。
在庫状況/標準価格の最新情報につきましては、当社Webサイト(www.fa.omron.co.jp)の「在庫状況/標準価格照会」をご覧ください。

詳細情報

Specifications

情報更新：2024/07/25

Power rating		240 W
Output voltage		24 V
Efficiency		93 % typ. (at three-phase 200 VAC input) 92 % typ. (Single-phase/two-phase 200 VAC input) Single-phase/two-phase 200 VAC input 93 % typ. (at three-phase 230 VAC input) 93 % typ. (Single-phase/two-phase 230 VAC input)
Input	Rated input voltage	200 to 240 VAC (Three-phase/single-phase/two-phase)
	Allowable input voltage variable range	170 to 264 VAC (Three-phase/single-phase/two-phase)/265 to 300 VAC (1 s) 240 to 350 VDC
	Frequency	50/60Hz (47 to 63 Hz)
	Rated input current	0.80 A typ. (at three-phase 200 VAC input) 1.4 A typ. (Single-phase/two-phase 200 VAC input) Single-phase/two-phase 200 VAC input 0.70 A typ. (at three-phase 230 VAC input) 1.2 A typ. (Single-phase/two-phase 230 VAC input)
	Power factor	0.9 min.
	Leakage current	1.0 mA max. (at three-phase 200 VAC input) 1.0 mA max. (at three-phase 230 VAC input)
	Inrush current (cold start at 25 °C)	13 A typ. (at three-phase 200 VAC input) 15 A typ. (at three-phase 230 VAC input)
Output	Rated output current	10 A
	Output voltage variable range	24 to 29.5 V With V.ADJ
	Maximum peak current	15 A
	Ripple	50 mV(p-p) max. at 20 MHz
	Static input variation influence	0.5 % max.
	Static load variation influence	1.5 % max.
	Ambient temperature variation influence	0.05 %/°C max.
	Start up time	1000 ms max. (at three-phase 200 VAC input) 1000 ms max. (at three-phase 230 VAC input)
	Hold time	35 ms typ. (at three-phase 200 VAC input) 35 ms typ. (at three-phase 230 VAC input)
Additional functions	Overload protection	Yes, automatic reset, intermittent operation type
	Overvoltage protection	Yes, 130% or higher of rated output voltage, power shut off (shut off the input voltage and turn on the input again)

	Overheat protection	No
	Series operation	Yes (Up to 2 Power Supplies with external diode)
	Parallel operation	Yes (Up to 2 Power Supplies)
	Alarm indication	Yes
Insulation	Dielectric strength	Between all input terminals and all output terminals, all signal terminals: 3 kVAC for 1 min, Cut-off current: 20 mA Between all input terminals and PE terminals: 2 kVAC for 1 min, Cut-off current: 20 mA (Between all output terminals, signal output terminals) and PE terminals: 1 kVAC for 1 min, Cut-off current: 25 mA Between all output terminals and all single output terminals: 0.5 kVAC for 1 min, Cut-off current: 10 mA
	Insulation resistance	Between all output terminals/all single output terminals and all input terminals/PE terminals: 100 MΩ min., at 500 VDC
Environment	Vibration resistance	10 to 55 Hz, 5 G max., 0.42 mm single amplitude in each 3 directions for 2 hours
	Shock resistance	294 m/s ² , 3 times each in 3 axes 6 directions
	Altitude	3000 m max.
	Ambient temperature (Operating)	-40 to 70 °C
	Ambient temperature (Storage)	-40 to 85 °C (with no freezing or condensation)
	Ambient humidity (Operating)	95 %RH max.
	Ambient humidity (Storage)	95 %RH max.
Reliability	MTBF	135,000 hours min.
	Life expectancy	10 years min. (at rated input, a load rate of 50% load, under the temperature of 40 °C max., standard mounting)
Construction	Construction	Covered type
	Connection	Terminal blocks
	Terminal type	Push-In Plus Terminal Block
	Mounting	DIN track mounting
	Coating	Yes
	Cooling fan	Cooling fan No
	Degree of protection	IP20, EN/IEC 60529
	Weight (Main)	800 g max.

Note

Do not use the Inverter output for the Power Supply. Inverters with an output frequency of 50/60 Hz are available, but the rise in the internal temperature of the Power Supply may result in ignition or burning.

Dimension

情報更新：2024/07/25

S8VK-WA24024

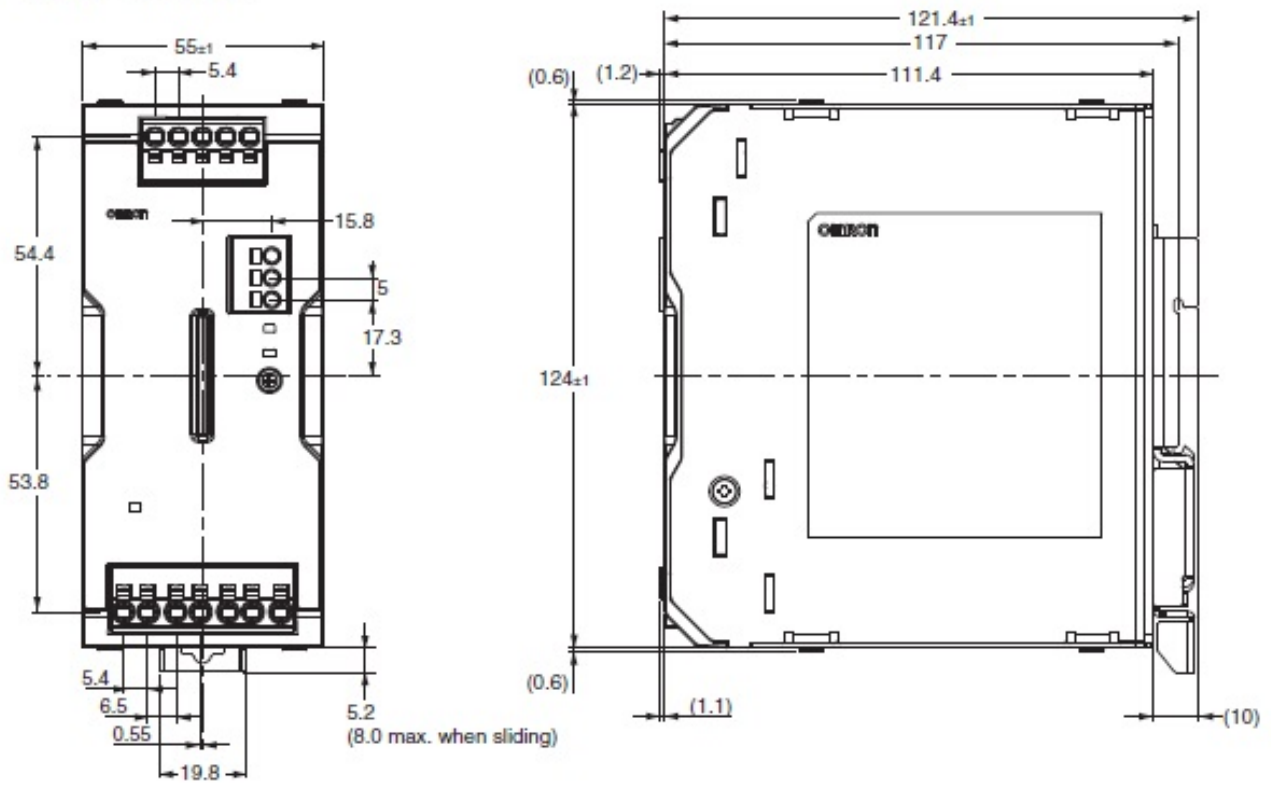

Mounting

情報更新：2024/07/25

Mounting state

(A) Standard (Vertical) mounting (B) Face-up mounting (C) Front, Side-by-side mounting

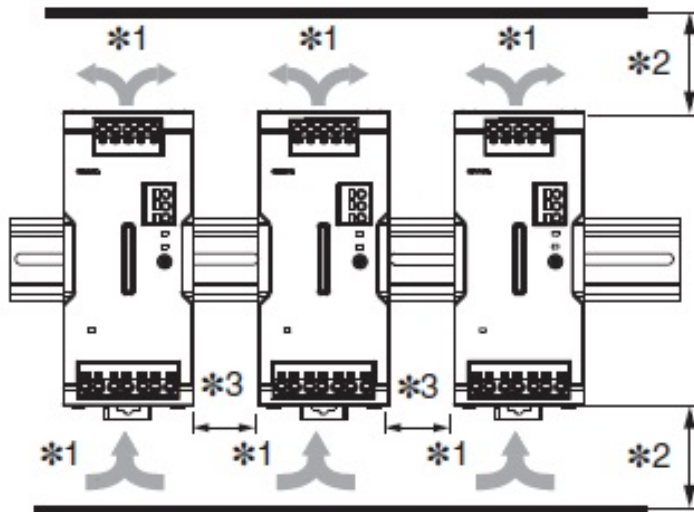
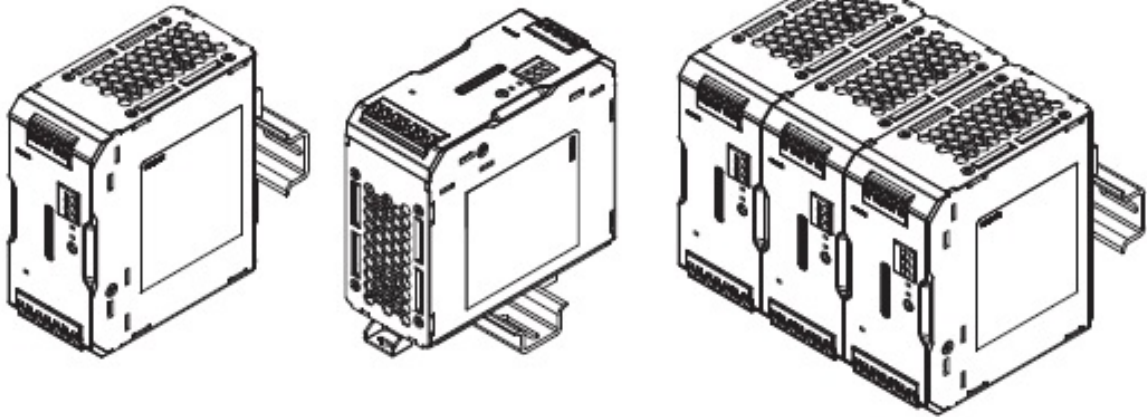

- *1. Convection of air
- *2. Vertical separation: 23 mm or more
- *3. Horizontal separation: 15mm or more (Standard mounting)
Horizontal separation: Less than 15 mm (Front, side-by-side mounting)

Connection diagram

情報更新：2024/07/25

Terminal arrangement

S8VK-WB240□□

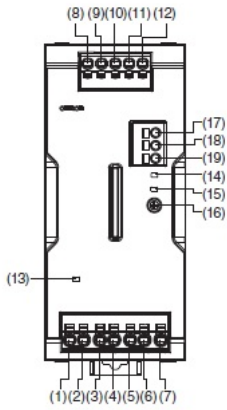

No.	Terminal name	Name	Function
(1)	L1/+ (1)	Input terminals	Connect the input lines to these terminals. *1
(2)	L1/+ (2)		
(3)	L2 (1)		
(4)	L2 (2)		
(5)	L3/- (1)	Protective Earth terminal (⊕)	Connect the ground line to this terminal. *2
(6)	L3/- (2)		
(7)	PE	DC Output terminals	Connect the load lines to these terminals.
(8)	+V1		
(9)	+V2		
(10)	-V1		
(11)	-V2		
(12)	-V3		
(13)	---	INPUT OK Indicator (INPUT OK: Green)	Lights up when the input voltage exceeds the lower limit value of the permissible range.
(14)	---	I _{out} > 100% Indicator (I _{out} > 100%: Yellow)	The I _{out} > 100% Indicator lights up when the output current exceeds the rated output current.
(15)	---	DC OK Indicator (DC OK: Green)	Lights up when the output voltage is more than 90% of the rated output voltage.
(16)	---	Output voltage adjuster (V.ADJ)	Use to adjust the output voltage.
(17)	I _{out} > 100%	I _{out} > 100% Signal Output Terminal	The I _{out} > 100% Signal Output is output when the output current exceeds the rated output current.
(18)	DC OK	DC OK Signal Output Terminal	Outputs when the output voltage is more than 90% of the rated output voltage.
(19)	COM	COM Terminal	Common terminal for Signal Output (17) and (18).

*1. For a two-phase power input, connect to (L1/+) and (L3/-).
For a DC power input, connect (L1/+) to (+), and (L3/-) to (-).

*2. This is the protective earth terminal specified in the safety standards. Always ground this terminal.

Block diagram

S8VK-WA24024 (240 W)

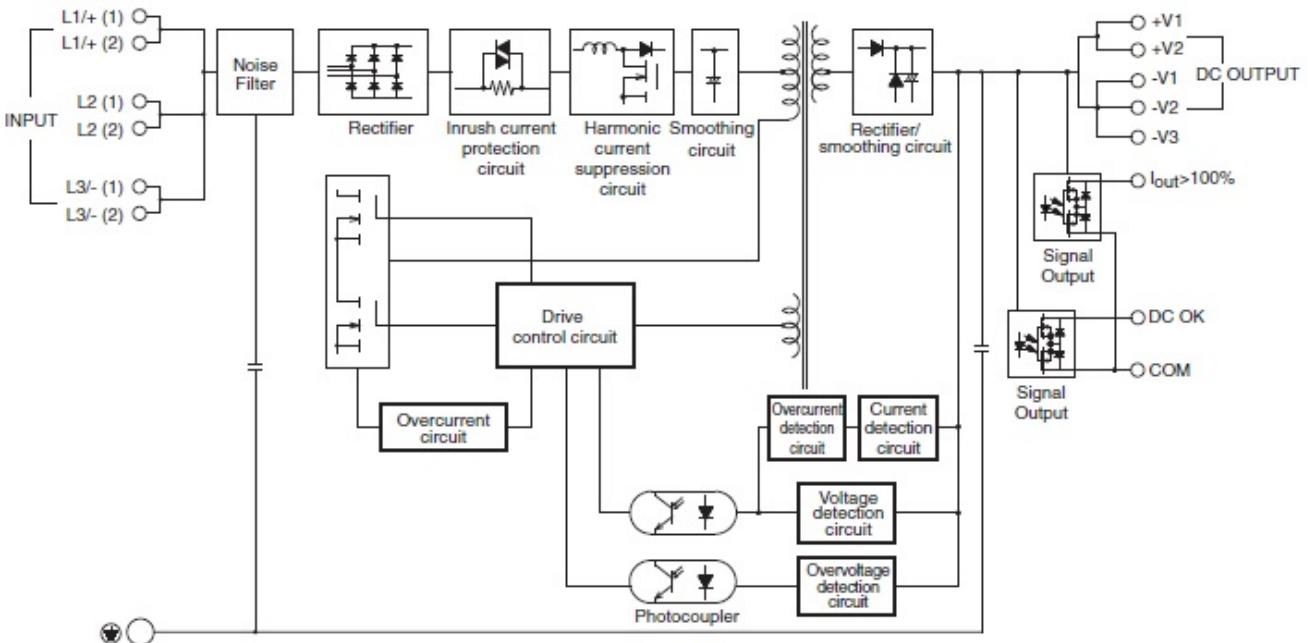

Derating curve

情報更新：2024/07/25

Derating Curves

240 W

<Horizontal separation: 15 mm or more>

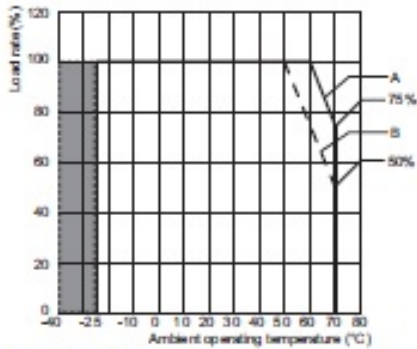

- Note:** 1. Multiply the above-shown load ratio by the coefficient of load reduction to input voltage.
2. In the shaded area, time is required to reach the rated output voltage after the input voltage is applied.
- A. Standard mounting
 - B. Face-up mounting

240 W/480 W/960 W/2000 W

<Horizontal separation: less than 15 mm>

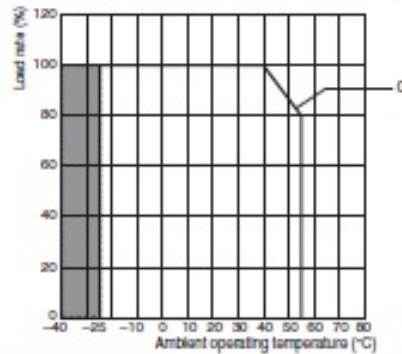

- Note:** 1. Apply the rated input voltage for three-phase, single-phase and two-phase.
2. In the shaded area, time is required to reach the rated output voltage after the input voltage is applied.
- C. Front, side-by-side mounting

Parallel operation (240 W/480 W/960 W)

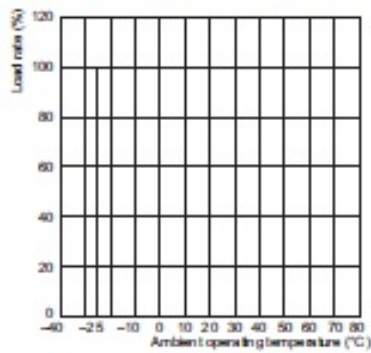

- Note:** Multiply the above-shown load ratio by the coefficient of load reduction to input voltage.
- A. Standard mounting

Parallel operation (2000 W)

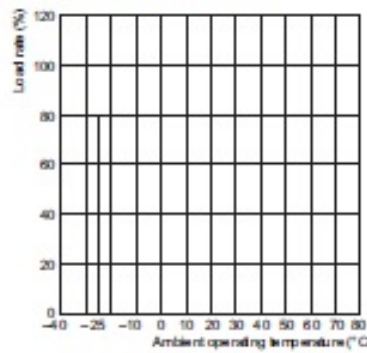

- Note:** Multiply the above-shown load ratio by the coefficient of load reduction to input voltage.
- A. Standard mounting

Coefficient of load reduction to input voltage

AC input

(three-phase/single-phase/two-phase)

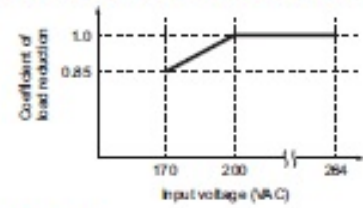

DC input

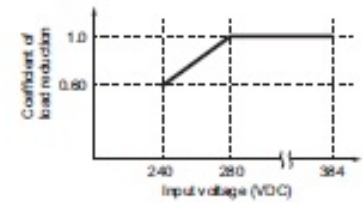

Between 2,000 and 3,000 m, derate the load according to the following derating curve.

240 W/480 W/960 W/2000 W
<Horizontal separation: 15 mm or more>

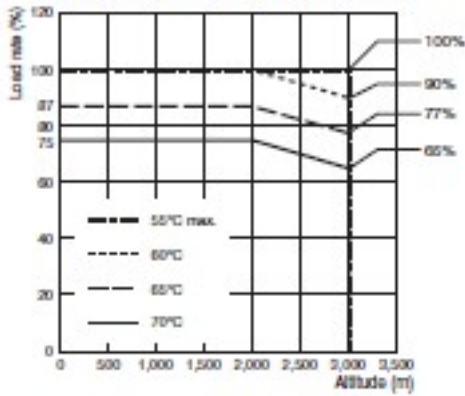

Note: Multiply the above-shown load ratio by the coefficient of load reduction to input voltage.

A. Standard mounting

240 W/480 W/960 W/2000 W
<Horizontal separation: less than 15 mm>

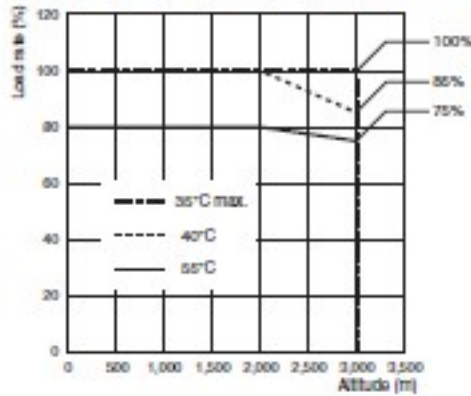

Note: Apply the rated input voltage for three-phase, single-phase and two-phase.

C. Front, side-by-side mounting

Coefficient of load reduction to input voltage

AC input
(three-phase/single-phase/two-phase)

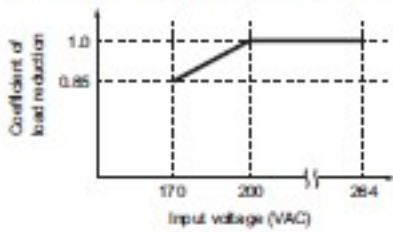

DC input

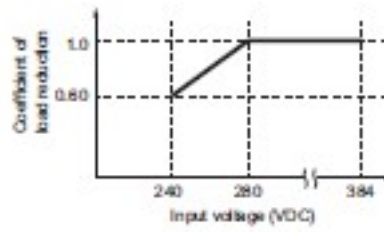

RoHS/REACH対応状況

情報更新：2026/6/03

EU RoHS

対応状況 ※1	対応予定月 ※2	非含有証明書 ※3
 対応済み		ダウンロードはこちら

中国 RoHS

中国 RoHS表 ※1※2										
Pb	Hg	Cd	Cr(VI)	PBBs	PBDEs	DBP	DIBP	BBP	DEHP	環境保護 使用期限
X	0	0	0	0	0	0	0	0	0	10

- ・“対応済み”や非含有の記載がされた商品であっても、流通在庫等で未対応品が混在する可能性があります。
- ・非含有品が必要な際は、弊社営業部門もしくは販売店へお問い合わせください。

[この製品のRoHS/REACH対応状況ページへ>](#)

注意事項・凡例

”対応済み”で記載される商品であっても、流通在庫等で未対応品が混在する可能性があります。
非含有品が必要な際は、弊社営業部門もしくは販売店へお問い合わせください。

※1 対応状況

- ・  対応済み : EU RoHS指令 (10物質) の非含有に対応した製品が提供可能な商品です。
- ・ 対応予定 : EU RoHS指令 (10物質) の非含有に対応した製品に切り替える予定のある商品です。
- ・ 対応予定なし : EU RoHS指令 (10物質) の非含有に非対応の商品で、対応品を出す予定はありません。
- ・ 調査・確認中 : EU RoHS指令 (10物質) の非含有の対応状況を調査中または確認中の商品です。
- ・ 非該当品 : ライセンス料など無形物で、有害物質有無と関係のない商品です。

仕入先様の事情により、非含有部品としていたものが、含有品と判明した場合などやむを得ず変更することがあります。

* EU RoHS指令 (10物質) :

鉛(Pb) 1000ppm以下、水銀(Hg) 1000ppm以下、カドミウム(Cd) 100ppm以下、六価クロム(Cr(VI)) 1000ppm以下、
ポリ臭化ビフェニル類(PBB) 1000ppm以下、ポリ臭化ジフェニルエーテル類(PBDE) 1000ppm以下、
フタル酸ビス(2-エチルヘキシル) (DEHP)(別名: DOP) 1000ppm以下、フタル酸ブチルベンジル (BBP) 1000ppm以下、
フタル酸ジブチル (DBP) 1000ppm以下、フタル酸ジイソブチル (DIBP) 1000ppm以下
但し、RoHS指令で産業用監視および制御機器に対する適用除外項目は除く。
フタル酸エステル類の4物質については閾値を超える意図的な使用がないことを確認しています。

※2 対応予定月

部品在庫の切り替え状況などにより、予定月が前後することがあります。

※3 非含有証明書ダウンロード

下記の非含有証明書をダウンロードすることができます。

- ・ EU RoHS指令 (10物質) の非含有証明書
- ・ 49物質の非含有証明書 (当社基準)

※ 本証明書は発行日時時点で非含有を証明するもので、過去に遡って非含有を証明するものではありません。

また、RoHS指令のフタル酸エステル類4物質の対応では、対応完了までの期間は出荷製品に未対応品が混在することから備考欄に
対応日を記載しておりました。

既に当社にて対応品への在庫切替を完了していることから、特段のことがない限り、2022年1月12日より割愛しております。

規格認証/適合状況

UL認証	CSA認証	CEマーキング	CCC認証	電波法
Yes	Yes	Yes	N/A	N/A

LR型式承認 (イギリス 船舶規格)	DNV型式承認 (ノルウェー 船舶規格)	BV型式承認 (フランス 船舶規格)	KR型式承認 (韓国 船舶規格)	NK型式承認 (日本 船舶規格)	ABS型式承認 (アメリカ 船舶規格)
No	No	No	No	No	No

[この製品の規格認証/適合状況ページへ>](#)
[その他の認証はこちらのページからご検索ください>](#)