

デジタルタコメータ

# H7CC-R11D



## 商品概要

Digital Tachometer, 1 stage (1 input and output), 6 digits, Contact output, 24 VAC/12 to 48 VDC, 11-pin socket

## 販売状況

2026/06/23 00:00 情報更新

|          |          |
|----------|----------|
| 販売状況     | 販売中      |
| 機種区分     | 標準在庫機種   |
| 標準価格(税別) | ¥ 21,000 |

推奨代替品の最新情報につきましては、当社Webサイト([www.fa.omron.co.jp](http://www.fa.omron.co.jp))の「生産終了品/推奨代替品」をご覧ください。  
在庫状況/標準価格の最新情報につきましては、当社Webサイト([www.fa.omron.co.jp](http://www.fa.omron.co.jp))の「在庫状況/標準価格照会」をご覧ください。

# 詳細情報

## Ratings/Specifications

情報更新：2025/06/19

|                         |                                     |  |
|-------------------------|-------------------------------------|--|
| Function                |                                     | Tachometer   |
| Rated supply voltage    |                                     | 24 VAC 50/60 Hz<br>12 to 48 VDC (Ripple 20 % max.)   |
| Operating voltage range |                                     | 85 to 110% of rated power supply voltage (90 to 110% at 12 to 48 VDC)  |
| Power consumption       |                                     | at 24 VAC: Approx. 5.5 VA<br>12 to 24 VDC: Approx. 3.3 W   |
| External power supply   |                                     | 12 VDC (±10%), 100 mA  |
| Tachometer              | Input mode                          | 1 input  |
|                         | Pulse measurement method            | Tachometer mode (cycle measurement)AMD-compatible mode (continuous measurement)  |
|                         | Max. counting speed                 | 30 Hz/10 kHz (switching)   |
|                         | Minimum input signal width          | 10 ms/1 ms (AMD-compatible mode (continuous measurement))  |
|                         | Sampling period                     | 200 ms min.  |
|                         | Measuring ranges                    | Tachometer mode (cycle measurement) (30 Hz): 0.001 to 30.00 Hz<br>Tachometer mode (cycle measurement) (10 kHz): 0.001 to 10 kHz<br>AMD-compatible mode (continuous measurement) (10 ms): 0.026 to 999999 s<br>AMD-compatible mode (continuous measurement) (1 ms): 0.003 to 999999 s |
|                         | Output modes                        | Upper and lower limit/ area/ upper limit/ lower limit  |
| Input                   | Input signal                        | Count  |
|                         | Input method                        | No-voltage (NPN)/Voltage input (PNP) selectable  |
|                         | No-voltage input (No-contact input) | Short-circuit (ON) impedance: 1 kΩ max. (Leakage current (0 Ω): Approx. 12 mA)<br>Residual voltage: 3 V max.<br>Open circuit impedance: 100 kΩ min.  |
|                         | No-voltage input (Contact input)    | Use a contact which can adequately switch 5 mA at 10 V.  |
|                         | Voltage input                       | High level: 4.5 to 30 VDC<br>Low level: 0 to 2 VDC (Input resistance Approx. 4.7 kΩ)   |
| Control output          | Contact output                      | SPDT<br>3 A at 250 VAC/30 VDC, resistive load (cos phi=1)<br>Minimum applicable load: 10 mA at 5 VDC (failure level:P reference value)   |

|                                 |                  |   |
|---------------------------------|------------------|---|
| Display                         | Display method   | 7-segment negative transmissive LCD   |
|                                 | Digits           | 6 digits  |
|                                 | Character height | Measurement value: 10 mm (White)<br>Comparison value: 6 mm (Green)  |
| Prescaling function             |                  | 0.001 to 99.999 (in Tachometer Mode)  |
| Decimal point adjustment        |                  | Rightmost 3 digits  |
| Key protection                  |                  | Key protect Switch  |
| Memory backup methods           |                  | Method: Non-volatile memory, Number of rewrite: 100,000 operations min., Store data: 10 years min.  |
| Ambient temperature (Operating) |                  | -10 to 55 °C (with no freezing or condensation)<br>Close mounting: -10 to 50 °C (with no freezing or condensation)  |
| Ambient temperature (Storage)   |                  | -25 to 70 °C (with no freezing or condensation)   |
| Ambient humidity (Operating)    |                  | 25 to 85 %  |
| Insulation resistance           |                  | Between current carrying terminals and exposed non-current carrying metal parts: 100 MΩ min. (at 500 VDC)<br>Between non-continuous contacts: 100 MΩ min. (at 500 VDC)  |
| Dielectric withstand voltage    |                  | Between current carrying metal parts and non-current carrying metal parts: 2,000 VAC, 50/60 Hz for 1 min<br>Between operating power circuit and input circuit: 1,500 VAC 50/60 Hz 1 min.<br>Between control output, and power supply/input circuit: 2,000 VAC, 50/60 Hz for 1 min<br>Between non-continuous contacts: 1,000 VAC, 50/60 Hz for 1 min |
| Impulse withstand voltage       |                  | Between power terminals: 1 kV<br>Between current carrying terminals and exposed non-current carrying metal parts: 1.5 kV  |
| Noise immunity                  |                  | square-wave noise by noise simulator (pulse width: 100 ns/1 μs, 1-ns rise)  |
| Static immunity                 |                  | Multifunction: 8 kV, Destruction: 15 kV   |
| Vibration resistance            |                  | Destruction: 10 to 55 Hz, 0.75 mm single amplitude each in 3 directions for 2 h<br>Malfunction: 10 to 55 Hz 0.35 mm single amplitude each in 3 directions for 10 min  |
| Shock resistance                |                  | Destruction: 300 m/s <sup>2</sup> , 3 times each in 3 axes each directions<br>Malfunction: 100 m/s <sup>2</sup> , 3 times each in 3 axes each directions  |
| Life expectancy                 |                  | Mechanical life 10 million operations min.<br>Electrical life 100,000 operations min. (3 A at 250 VAC resistive load)   |
| Degree of protection            |                  | Case front: IEC IP66 when Y92S-P6 Waterproof Packing is used  |
| External connection method      |                  | 11-pin round socket   |
| Case color                      |                  | Black (N1.5)  |

|             |                             |
|-------------|-----------------------------|
| Accessories | Three of Instruction Manual |
| Weight      | Approx. 100 g               |

# Dimensions

## H7CC-R□

情報更新：2025/06/19

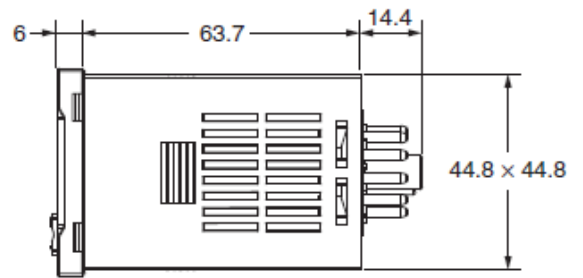
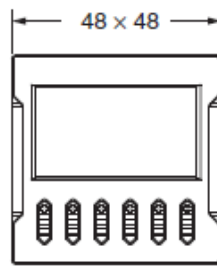
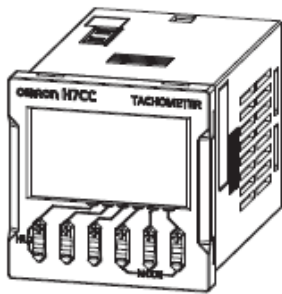

## Terminal arrangement

情報更新：2025/06/19

### H7CC-R11 H7CC-R11D

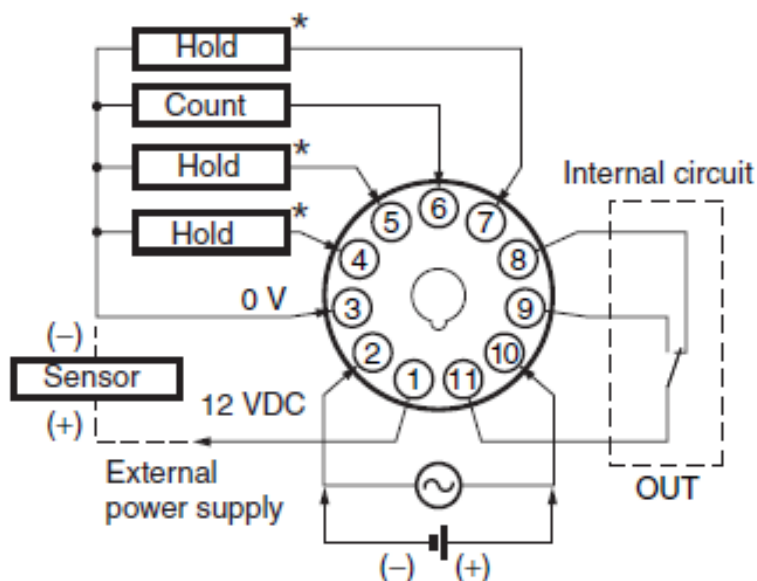

- \* The hold function is the same whichever terminal is connected. Terminals are not connected internally, and so do not use them for cross-over wiring.

# Input connection diagram

情報更新：2025/06/19

No-voltage input:

## No-voltage Inputs (NPN Inputs)

### Open Collector

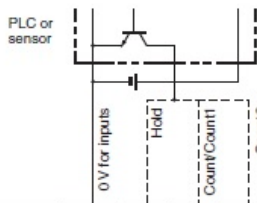

|            |   |     |   |    |
|------------|---|-----|---|----|
| H7CC-R11□  | ③ | ④⑤⑦ | ⑥ | -- |
| H7CC-R11W□ | ③ | --  | ⑥ | ⑤  |

Note: Operates when the transistor turns ON.

### Voltage Output

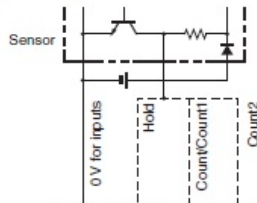

|            |   |     |   |    |
|------------|---|-----|---|----|
| H7CC-R11□  | ③ | ④⑤⑦ | ⑥ | -- |
| H7CC-R11W□ | ③ | --  | ⑥ | ⑤  |

Note: Operates when the transistor turns ON.

### Contact Input

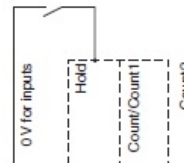

|            |   |     |   |    |
|------------|---|-----|---|----|
| H7CC-R11□  | ③ | ④⑤⑦ | ⑥ | -- |
| H7CC-R11W□ | ③ | --  | ⑥ | ⑤  |

Note: Operates when the contact turns ON.

### DC Two-wire Sensor

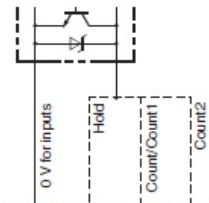

|            |   |     |   |    |
|------------|---|-----|---|----|
| H7CC-R11□  | ③ | ④⑤⑦ | ⑥ | -- |
| H7CC-R11W□ | ③ | --  | ⑥ | ⑤  |

Note: Operates when the transistor turns ON.

## No-voltage Input Signal Levels

|                  |  |
|------------------|--|
| No-contact input | Short-circuit level (Transistor ON)  |
|                  | <ul style="list-style-type: none"> <li>Residual voltage: 3 V max.</li> <li>Impedance when ON: 1 kΩ max.</li> </ul> (The leakage current is approx. 12 mA when the impedance is 0 Ω.) |
| Contact input    | Open level (Transistor OFF)  |
|                  | <ul style="list-style-type: none"> <li>Impedance when OFF: 100 kΩ min.</li> </ul>  |

Note: The DC voltage must be 30 VDC max.

### Applicable Two-wire Sensor

- Leakage current: 1.5 mA max.
- Switching capacity: 5 mA min.
- Residual voltage: 3 VDC max.
- Operating voltage: 10 VDC

Voltage input:

## Voltage Inputs (PNP Inputs)

### No-contact Input (NPN Transistor)

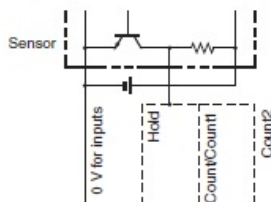

|            |   |     |   |    |
|------------|---|-----|---|----|
| H7CC-R11□  | ③ | ④⑤⑦ | ⑥ | -- |
| H7CC-R11W□ | ③ | --  | ⑥ | ⑤  |

Note: Operates when the transistor turns ON.

### No-contact Input (PNP Transistor)

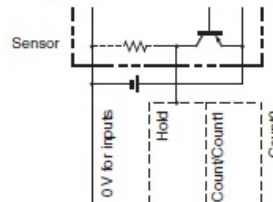

|            |   |     |   |    |
|------------|---|-----|---|----|
| H7CC-R11□  | ③ | ④⑤⑦ | ⑥ | -- |
| H7CC-R11W□ | ③ | --  | ⑥ | ⑤  |

Note: Operates when the transistor turns ON.

### Contact Input

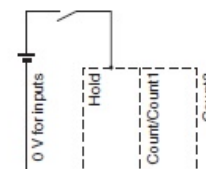

|            |   |     |   |    |
|------------|---|-----|---|----|
| H7CC-R11□  | ③ | ④⑤⑦ | ⑥ | -- |
| H7CC-R11W□ | ③ | --  | ⑥ | ⑤  |

Note: Operates when the contact turns ON.

## Voltage Input Signal Levels

|                                      |   |
|--------------------------------------|---|
| High level (Input ON): 4.5 to 30 VDC | <b>Note:</b> 1. The DC voltage must be 30 VDC max.<br>2. Input resistance: Approx. 4.7 kΩ |
| Low level (Input OFF): 0 to 2 VDC    |   |

# Input/Output Mode Setting

## Models Other Than H7CC-R11W□ in Tachometer Mode

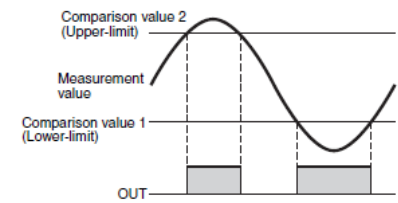
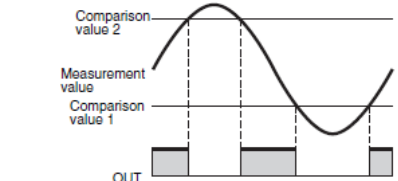
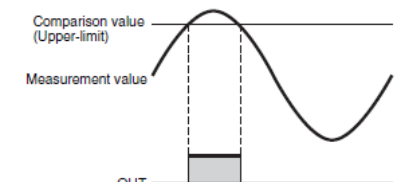
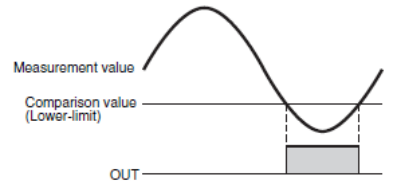
| Output mode setting          | Operation  |   |  |   |              |   |   |
|------------------------------|--|---|--|---|--------------|---|---|
| <b>Upper and lower limit</b> |  <p>ON condition: Measurement value <math>\leq</math> Comparison value 1 or Measurement value <math>\geq</math> Comparison value 2<br/> <b>Note:</b> When comparison value 1 <math>\geq</math> Comparison value 2, the output is always ON regardless of the comparison value.</p>  |   |  |   |              |   |   |
| <b>Area</b>                  |  <table border="1" data-bbox="263 817 742 929"> <thead> <tr> <th>Condition</th> <th>Comparison value 1 <math>\leq</math> Comparison value 2</th> <th>Comparison value 1 <math>&gt;</math> Comparison value 2</th> </tr> </thead> <tbody> <tr> <th>ON condition</th> <td>Comparison value 1 <math>\leq</math> measurement value <math>\leq</math> Comparison value 2</td> <td>Comparison value 2 <math>\leq</math> measurement value <math>\leq</math> Comparison value 1</td> </tr> </tbody> </table> | Condition   | Comparison value 1 $\leq$ Comparison value 2 | Comparison value 1 $>$ Comparison value 2 | ON condition | Comparison value 1 $\leq$ measurement value $\leq$ Comparison value 2 | Comparison value 2 $\leq$ measurement value $\leq$ Comparison value 1 |
| Condition                    | Comparison value 1 $\leq$ Comparison value 2   | Comparison value 1 $>$ Comparison value 2                             |  |   |              |   |   |
| ON condition                 | Comparison value 1 $\leq$ measurement value $\leq$ Comparison value 2  | Comparison value 2 $\leq$ measurement value $\leq$ Comparison value 1 |  |   |              |   |   |
| <b>Upper limit</b>           |  <p>ON condition: Measurement value <math>\geq</math> Comparison value</p>   |   |  |   |              |   |   |
| <b>Lower limit</b>           |  <p>ON condition: Measurement value <math>\leq</math> Comparison value</p>  |   |  |   |              |   |   |

## Models Other Than H7CC-R11W□ in AMD-compatible Mode

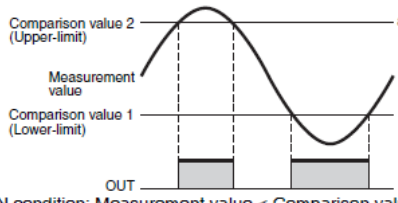
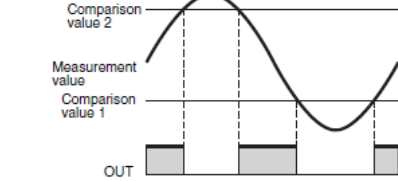
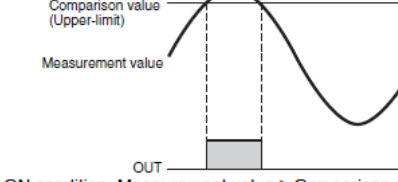
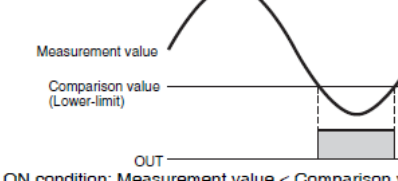
| Output mode setting          | Operation  |  |  |   |              |  |  |
|------------------------------|--|--|--|---|--------------|--|--|
| <b>Upper and lower limit</b> |  <p>ON condition: Measurement value <math>&lt;</math> Comparison value 1 or Measurement value <math>\geq</math> Comparison value 2<br/> <b>Note:</b> When comparison value 1 <math>\geq</math> comparison value 2, the output is always ON regardless of the comparison value.</p>   |  |  |   |              |  |  |
| <b>Area</b>                  |  <table border="1" data-bbox="949 817 1428 929"> <thead> <tr> <th>Condition</th> <th>Comparison value 1 <math>\leq</math> Comparison value 2</th> <th>Comparison value 1 <math>&gt;</math> Comparison value 2</th> </tr> </thead> <tbody> <tr> <th>ON condition</th> <td>Comparison value 1 <math>\leq</math> measurement value <math>&lt;</math> Comparison value 2</td> <td>Comparison value 2 <math>\leq</math> measurement value <math>&lt;</math> Comparison value 1</td> </tr> </tbody> </table> | Condition  | Comparison value 1 $\leq$ Comparison value 2 | Comparison value 1 $>$ Comparison value 2 | ON condition | Comparison value 1 $\leq$ measurement value $<$ Comparison value 2 | Comparison value 2 $\leq$ measurement value $<$ Comparison value 1 |
| Condition                    | Comparison value 1 $\leq$ Comparison value 2   | Comparison value 1 $>$ Comparison value 2                          |  |   |              |  |  |
| ON condition                 | Comparison value 1 $\leq$ measurement value $<$ Comparison value 2   | Comparison value 2 $\leq$ measurement value $<$ Comparison value 1 |  |   |              |  |  |
| <b>Upper limit</b>           |  <p>ON condition: Measurement value <math>\geq</math> Comparison value</p>  |  |  |   |              |  |  |
| <b>Lower limit</b>           |  <p>ON condition: Measurement value <math>&lt;</math> Comparison value</p>   |  |  |   |              |  |  |

**Note:** If time "a" is exceeded during operation, the output will turn ON. If time "b" is exceeded during operation, the output will turn OFF. (If average processing is enabled, the output operation will be performed when the time is exceeded once.)

# Electrical life

情報更新：2025/06/19

# Life-test Curve (Reference Values) Resistive Load

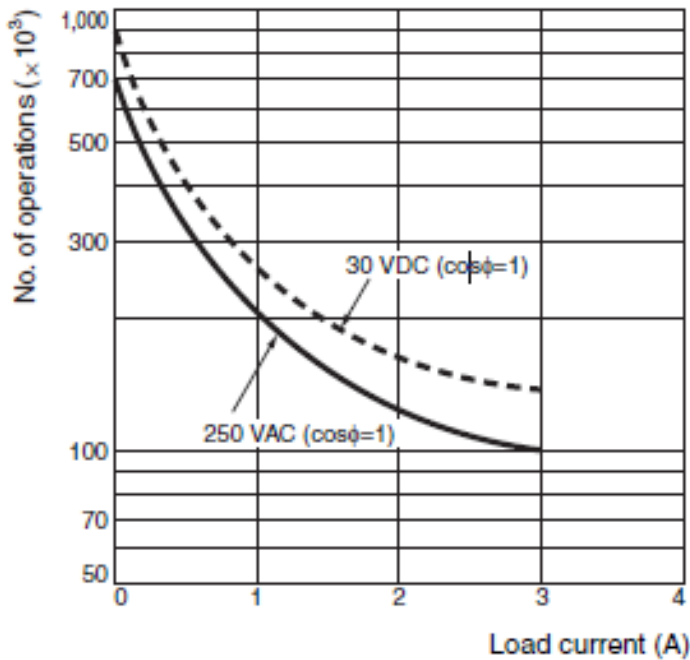

# Inductive Load

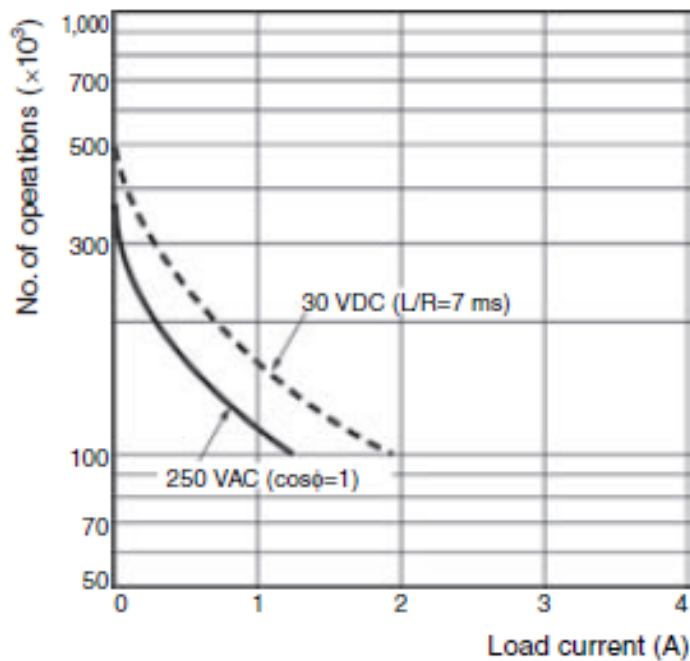

A current of 0.15 A max. can be switched at 125 VDC ( $\cos\phi=1$ ) (Life expectancy: 100,000 operations)

A current of 0.1 A max. can be switched if  $L/R=7$  ms.  
(Life expectancy: 100,000 operations)



## RoHS/REACH対応状況

情報更新：2026/6/17

### EU RoHS

| 対応状況 ※1  | 対応予定月 ※2 | 非含有証明書 ※3                  |
|--|----------|----------------------------|
|  対応済み |          | <a href="#">ダウンロードはこちら</a> |

### 中国 RoHS

| 中国 RoHS表 ※1※2 |    |    |        |      |       |     |      |     |      |              |
|---------------|----|----|--------|------|-------|-----|------|-----|------|--------------|
| Pb            | Hg | Cd | Cr(VI) | PBBs | PBDEs | DBP | DIBP | BBP | DEHP | 環境保護<br>使用期限 |
| X             | 0  | 0  | 0      | 0    | 0     | 0   | 0    | 0   | 0    | 10           |

- ・“対応済み”や非含有の記載がされた商品であっても、流通在庫等で未対応品が混在する可能性があります。
- ・非含有品が必要な際は、弊社営業部門もしくは販売店へお問い合わせください。

[この製品のRoHS/REACH対応状況ページへ>](#)

## 注意事項・凡例

”対応済み”で記載される商品であっても、流通在庫等で未対応品が混在する可能性があります。  
非含有品が必要な際は、弊社営業部門もしくは販売店へお問い合わせください。

### ※1 対応状況

- ・  対応済み : EU RoHS指令（10物質）の非含有に対応した製品が提供可能な商品です。
- ・ 対応予定 : EU RoHS指令（10物質）の非含有に対応した製品に切り替える予定のある商品です。
- ・ 対応予定なし : EU RoHS指令（10物質）の非含有に非対応の商品で、対応品を出す予定はありません。
- ・ 調査・確認中 : EU RoHS指令（10物質）の非含有の対応状況を調査中または確認中の商品です。
- ・ 非該当品 : ライセンス料など無形物で、有害物質有無と関係のない商品です。

仕入先様の事情により、非含有部品としていたものが、含有品と判明した場合などやむを得ず変更することがあります。

\* EU RoHS指令（10物質）：

鉛(Pb) 1000ppm以下、水銀(Hg) 1000ppm以下、カドミウム(Cd) 100ppm以下、六価クロム(Cr(VI)) 1000ppm以下、  
ポリ臭化ビフェニル類(PBB) 1000ppm以下、ポリ臭化ジフェニルエーテル類(PBDE) 1000ppm以下、  
フタル酸ビス(2-エチルヘキシル) (DEHP)(別名：DOP) 1000ppm以下、フタル酸ブチルベンジル (BBP) 1000ppm以下、  
フタル酸ジブチル (DBP) 1000ppm以下、フタル酸ジイソブチル (DIBP) 1000ppm以下  
但し、RoHS指令で産業用監視および制御機器に対する適用除外項目は除く。  
フタル酸エステル類の4物質については閾値を超える意図的な使用がないことを確認しています。

### ※2 対応予定月

部品在庫の切り替え状況などにより、予定月が前後することがあります。

### ※3 非含有証明書ダウンロード

下記の非含有証明書をダウンロードすることができます。

- ・ EU RoHS指令（10物質）の非含有証明書
- ・ 49物質の非含有証明書（当社基準）

※ 本証明書は発行日時時点で非含有を証明するもので、過去に遡って非含有を証明するものではありません。

また、RoHS指令のフタル酸エステル類4物質の対応では、対応完了までの期間は出荷製品に未対応品が混在することから備考欄に  
対応日を記載しておりました。

既に当社にて対応品への在庫切替を完了していることから、特段のことがない限り、2022年1月12日より割愛しております。

## 規格認証/適合状況

| UL認証 | CSA認証 | CEマーキング | CCC認証 | 電波法 |
|------|-------|---------|-------|-----|
| Yes  | Yes   | Yes     | N/A   | N/A |

| LR型式承認<br>(イギリス<br>船舶規格) | DNV型式承認<br>(ノルウェー<br>船舶規格) | BV型式承認<br>(フランス<br>船舶規格) | KR型式承認<br>(韓国<br>船舶規格) | NK型式承認<br>(日本<br>船舶規格) | ABS型式承認<br>(アメリカ<br>船舶規格) |
|--------------------------|----------------------------|--------------------------|------------------------|------------------------|---------------------------|
| No                       | No                         | No                       | No                     | No                     | No                        |

[この製品の規格認証/適合状況ページへ>](#)  
[その他の認証はこちらのページからご検索ください>](#)