

電子カウンタ

# H7CC-A11D



## 商品概要

Digital Counter, Preset Counter, 1 stage, 6 digits, Contact output (SPDT), 24 VAC/12 to 48 VDC, 11-pin socket

## 販売状況

2026/07/01 00:00 情報更新

販売状況	販売中
機種区分	標準在庫機種
標準価格(税別)	¥ 23,000

推奨代替品の最新情報につきましては、当社Webサイト([www.fa.omron.co.jp](http://www.fa.omron.co.jp))の「生産終了品/推奨代替品」をご覧ください。  
在庫状況/標準価格の最新情報につきましては、当社Webサイト([www.fa.omron.co.jp](http://www.fa.omron.co.jp))の「在庫状況/標準価格照会」をご覧ください。

# 詳細情報

## Ratings/Specifications

情報更新：2025/06/19

Function		1 Stage Preset Counter, Total Preset Counter
Preset stages		1 step
Rated supply voltage		24 VAC 50/60 Hz 12 to 48 VDC (Ripple 20 % max.)
Operating voltage range		85 to 110% of rated power supply voltage (90 to 110% at 12 to 48 VDC)
Power consumption		at 24 VAC: Approx. 5.5 VA 12 to 24 VDC: Approx. 3.3 W
External power supply		12 VDC ( $\pm 10\%$ ), 100 mA
Counter	Count range	-99999 to 999999
	Max. counting speed	30 Hz/10 kHz (switching) (ON/OFF ratio 1:1)
	Input mode	Increment (UP), decrement (DOWN), increment/decrement (UP/DOWN A (command input), UP/DOWN B (individual inputs), or UP/DOWN C (quadrature inputs)), UP/DOWN D (command input), UP/DOWN E (individual inputs), UP/DOWN E (quadrature inputs))
	Output modes	N, F, C, R, K-1, P, Q, A, K-2, D, L
	One-shot output time	0.01 to 99.99 s
	Reset system	External (Minimum input signal width: 1 ms/20 ms selectable, manual and automatic reset (internal according to C, R, P and Q mode operation))
Input	Input signal	CP1, CP2, Reset, Total reset
	Input method	No-voltage (NPN)/Voltage input (PNP) selectable
	No-voltage input (No-contact input)	Short-circuit (ON) impedance: 1 k $\Omega$ max. (Leakage current (0 $\Omega$ ): Approx. 12 mA) Residual voltage: 3 V max. Open circuit impedance: 100 k $\Omega$ min.
	No-voltage input (Contact input)	Use a contact which can adequately switch 5 mA at 10 V.
	Voltage input	High level: 4.5 to 30 VDC Low level: 0 to 2 VDC (Input resistance Approx. 4.7 k $\Omega$ )
Reset time	External reset	1 ms/20 ms (selectable)
Control output	Contact output	SPDT 3 A at 250 VAC/30 VDC, resistive load (cos phi=1) Minimum applicable load: 10 mA at 5 VDC (failure level:P reference value)

Display	Display method	7-segment negative transmissive LCD
	Digits	6 digits
	Character height	Count value: 10 mm (White) Set value: 6 mm (Green)
Prescaling function		0.001 to 99.999
Decimal point adjustment		Rightmost 3 digits
Key protection		Key protect Switch
Memory backup methods		Method: Non-volatile memory, Number of rewrite: 100,000 operations min., Store data: 10 years min.
Ambient temperature (Operating)		-10 to 55 °C (with no freezing or condensation) Close mounting: -10 to 50 °C (with no freezing or condensation)
Ambient temperature (Storage)		-25 to 70 °C (with no freezing or condensation)
Ambient humidity (Operating)		25 to 85 %
Insulation resistance		Between current carrying terminals and exposed non-current carrying metal parts: 100 MΩ min. (at 500 VDC) Between non-continuous contacts: 100 MΩ min. (at 500 VDC)
Dielectric withstand voltage		Between current carrying metal parts and non-current carrying metal parts: 2,000 VAC, 50/60 Hz for 1 min Between operating power circuit and input circuit: 1,500 VAC 50/60 Hz 1 min. Between control output, and power supply/input circuit: 2,000 VAC, 50/60 Hz for 1 min Between non-continuous contacts: 1,000 VAC, 50/60 Hz for 1 min
Impulse withstand voltage		Between power terminals: 1 kV Between current carrying terminals and exposed non-current carrying metal parts: 1.5 kV
Noise immunity		square-wave noise by noise simulator (pulse width: 100 ns/1 μs, 1-ns rise)
Static immunity		Multifunction: 8 kV, Destruction: 15 kV
Vibration resistance		Destruction: 10 to 55 Hz, 0.75 mm single amplitude each in 3 directions for 2 h Malfunction: 10 to 55 Hz 0.35 mm single amplitude each in 3 directions for 10 min
Shock resistance		Destruction: 300 m/s <sup>2</sup> , 3 times each in 3 axes each directions Malfunction: 100 m/s <sup>2</sup> , 3 times each in 3 axes each directions
Life expectancy		Mechanical life 10 million operations min. Electrical life 100,000 operations min. (3 A at 250 VAC resistive load)
Degree of protection		Case front: IEC IP66 when Y92S-P6 Waterproof Packing is used
External connection method		11-pin round socket
Case color		Black (N1.5)

Accessories	Three of Instruction Manual
Weight	Approx. 120 g

## Dimensions

情報更新：2025/06/19

### H7CC-A11/-A11S/-A11D/-A11SD (Flush Mounting/Surface Mounting Models)

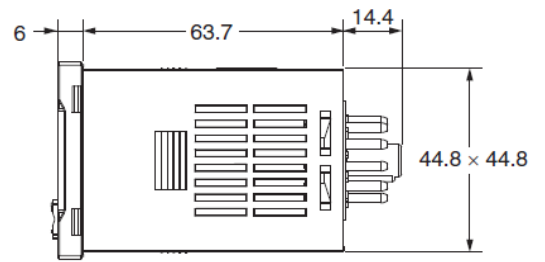
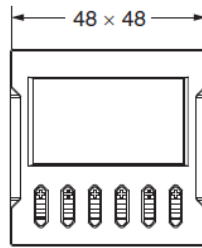
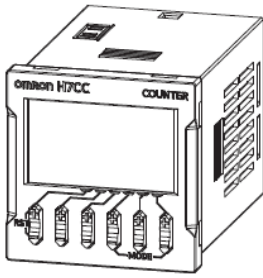

# Terminal arrangement

情報更新：2025/06/19

## H7CC-A11/-A11D

### 1-stage Contact Output

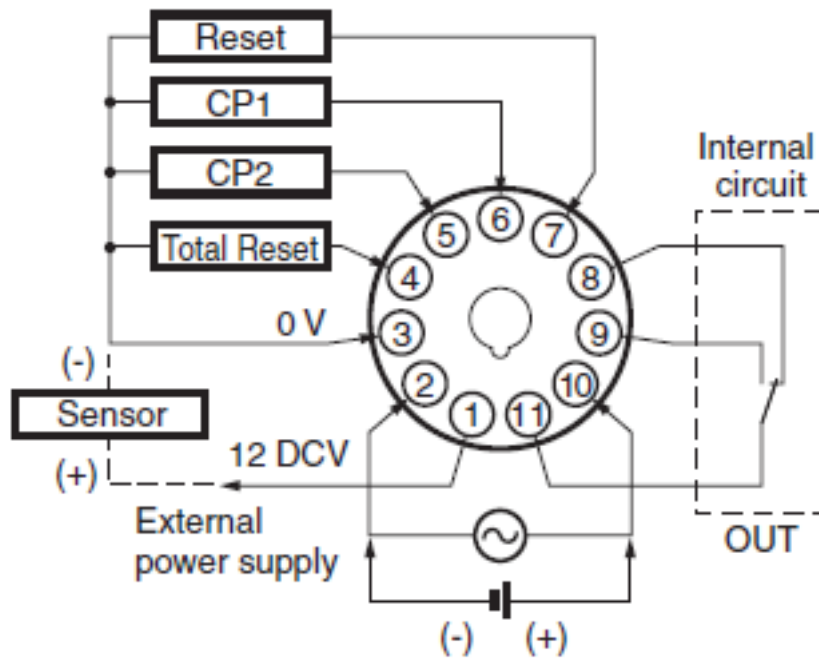

# Input connection diagram

情報更新：2025/06/19

No-voltage input:

## No-voltage Inputs (NPN Inputs)

### Open Collector

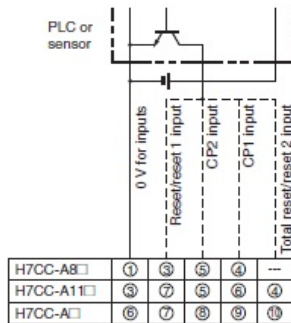

Note: Operates with transistor ON.

### Voltage Output

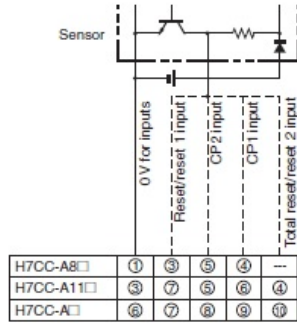

Note: Operates with transistor ON.

### Contact Input

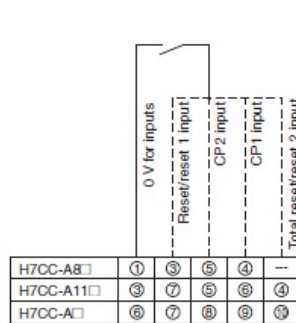

Note: Operates with relay ON.

### DC Two-wire Sensor

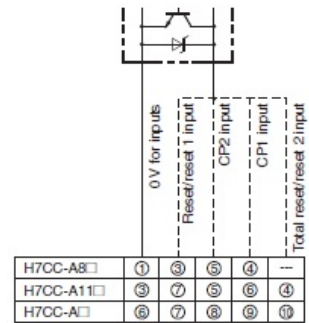

Note: Operates with transistor ON.

## No-voltage Input Signal Levels

No-contact input	Short-circuit level (transistor ON)
	<ul style="list-style-type: none"> <li>Residual voltage: 3 V max.</li> <li>Impedance when ON: 1 kΩ max.</li> </ul> <p>(The leakage current is approx. 12 mA when the impedance is 0 Ω.)</p>
Contact input	Open level (transistor OFF)
	<ul style="list-style-type: none"> <li>Impedance when OFF: 100 kΩ min.</li> </ul>

Note: The DC voltage must be 30 VDC max.

## Applicable Two-wire Sensor

- Leakage current: 1.5 mA max.
- Switching capacity: 5 mA min.
- Residual voltage: 3 VDC max.
- Operating voltage: 10 VDC

Voltage input:

## Voltage Inputs (PNP Inputs)

### No-contact Input (NPN Transistor)

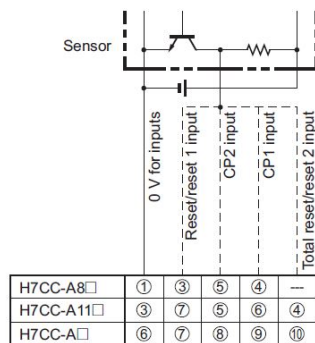

Note: Operates with transistor ON.

### No-contact Input (PNP Transistor)

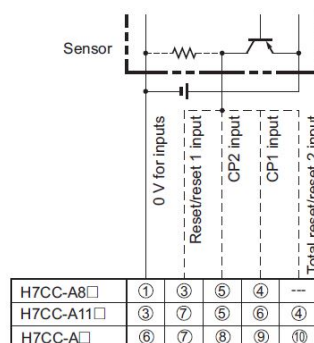

Note: Operates with transistor ON.

### Contact Input

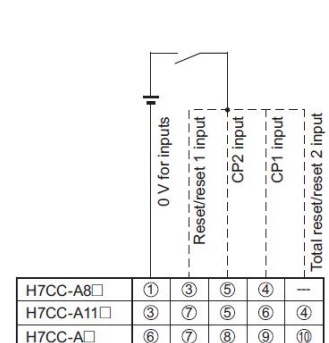

Note: Operates with relay ON.

## Voltage Input Signal Levels

High level (input ON): 4.5 to 30 VDC

Low level (input OFF): 0 to 2 VDC

- Note: 1. The DC voltage must be 30 VDC max.  
2. Input resistance: Approx. 4.7 kΩ

# Input Modes and Present Value

情報更新：2025/06/19

## Input Modes and Present Value (See note 1.)

### I/O Functions for Counter Operation



\* Counting starts when the CP1 is turned ON after turning ON the power.



- Note: 1. If the configuration selection is set to dual counter, CP1 and CP2 input will operate in the same way as the count input (CP1) of UP (increment) mode.  
 2. ⑤ must be greater than the minimum signal width and ⑥ must be at least 1/2 the minimum signal width. If they are less, a count error of  $\pm 1$  may occur.  
 3. Minimum signal width: 16.7 ms (when maximum counting speed = 30 Hz)  
 100  $\mu$ s (when maximum counting speed = 5 kHz)  
 4. The meaning of the H and L symbols in the tables is explained below.

Symbol	Input method	No-voltage input (NPN input)	Voltage input (PNP input)
H		Short-circuit	4.5 to 30 VDC
L		Open	0 to 2 VDC



# Input/Output Mode Setting

情報更新：2025/06/19

## Input/Output Mode Settings I/O Functions for Counter Operation

If a 1-stage model or 2-stage model is used as twin counter, the operation for output 2 will be performed. When using a 2-stage model as a 1-stage preset counter, total and preset counter, or dual counter, OUT1 and OUT2 turn ON and OFF simultaneously.



		Input mode		Operation after count completion	
		UP	DOWN		
Output mode setting	N			The outputs and present value display are held until reset/reset 1 is input.	
	F				The present value display continues to increase/decrease. The outputs are held until reset/reset 1 is input.

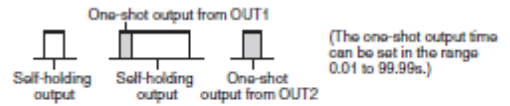

		Input mode		Operation after count completion	
Output mode setting	C	UP	DOWN	<p>As soon as the count reaches SV, the present value display returns to the reset start status. The present value display does not show the present value upon count-up. The outputs repeat one-shot operation.</p> <p>OUT1 self-holding output turns OFF after the OUT2 one-shot output time. The OUT1 one-shot output time is independent of OUT2.</p>	
		UP/DOWN A, B, C	UP/DOWN D, E, F		
		UP	DOWN		
		UP/DOWN A, B, C	UP/DOWN D, E, F		
	R	UP	DOWN		<p>The present value display returns to the reset start status after the one-shot output time. The outputs repeat one-shot operation. OUT1 self-holding output turns OFF after the OUT2 one-shot output time. The OUT1 one-shot output time is independent of OUT2.</p>
		UP/DOWN A, B, C	UP/DOWN D, E, F		
		UP	DOWN		
		UP/DOWN A, B, C	UP/DOWN D, E, F		

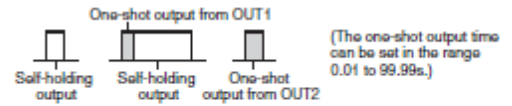

		Input mode		Operation after count completion
Output mode setting	K-1	UP	DOWN	<p>The present value display continues to increase/decrease.                      OUT1 self-holding output turns OFF after the OUT2 one-shot output time.                      The OUT1 one-shot output time is independent of OUT2.</p>
		UP/DOWN A, B, C	UP/DOWN D, E, F	
	P	UP	DOWN	
		UP/DOWN A, B, C	UP/DOWN D, E, F	



		Input mode		Operation after count completion	
		UP	DOWN		
Output mode setting	Q			<p>The present value continues to increase/decrease for the one-shot output time, but returns to the reset start status after the one-shot output time has elapsed.</p> <p>The outputs repeat one-shot operation.</p> <p>OUT1 self-holding output turns OFF after the OUT2 one-shot output time.</p> <p>The OUT1 one-shot output time is independent of OUT2.</p>	
	A				<p>The present value display and OUT1 self-holding output is held until reset/reset 1 is input.</p> <p>OUT1 and OUT2 are independent.</p>

- Note:**
- When the present value reaches 999999, it returns to 0.
  - Counting cannot be performed during reset/reset 1 input.
  - If reset/reset 1 is input while one-shot output is ON, one-shot output turns OFF.
  - If there is power interruption while output is ON, output will turn ON again when the power supply has recovered, if memory backup is enabled.  
For one-shot output, output will turn ON again for the duration of the output time setting once the power supply has recovered.
  - Do not use the counter function in applications where the count may be completed (again) while one-shot output is ON.
  - The setting range is 0 to 999999.



		Input mode	Operation after count completion
		UP/DOWN A, B, C	
Output mode setting	K-2		The display continues to increase/decrease until the overflow or underflow value is reached. One-shot output only.
	D		The display continues to increase/decrease until the overflow or underflow value is reached. The outputs are ON while the count is equal.
	L		The display continues to increase/decrease until the overflow or underflow value is reached. OUT1 is held while the present value is less than or equal to set value 1. OUT2 is held while the present value is greater than or equal to set value 2.
	H		The display continues to increase/decrease until the overflow or underflow value is reached. OUT1 is held while the present value is greater than or equal to set value 1. OUT2 is held while the present value is greater than or equal to set value 2. * H mode is available only when using a model as a 2-stage counter.

- Note:**
- Counting cannot be performed during reset/reset 1 input.
  - If reset/reset 1 is input while one-shot output is ON, one-shot output turns OFF.
  - If there is power interruption while output is ON, output will turn ON again when the power supply has recovered, if memory backup is enabled.  
For one-shot output, output will turn ON again for the duration of the output time setting once the power supply has recovered.
  - Do not use the counter function in applications where the count may be completed (again) while one-shot output is ON.
  - The set value is from -99999 to 999999.

# Electrical life

情報更新：2025/06/19

## Resistive load

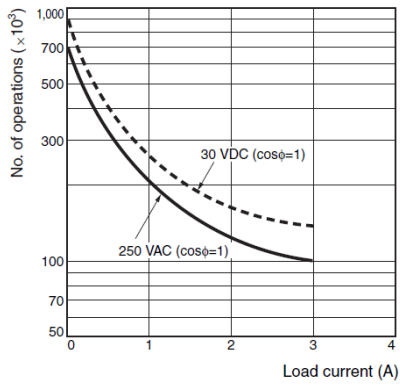

## Inductive load

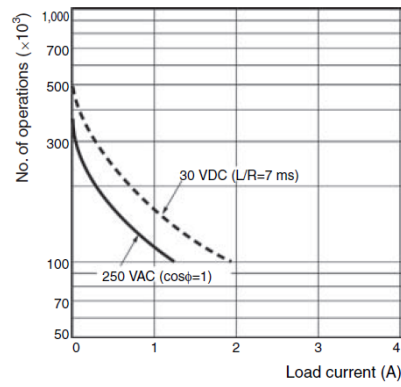

A current of 0.15 A max. can be switched at 125 VDC ( $\cos\phi=1$ ) and current of 0.1 A max. can be switched if  $L/R=7$  ms. In both cases, a life of 100,000 operations can be expected.

## RoHS/REACH対応状況

情報更新：2026/7/01

### EU RoHS

対応状況 ※1	対応予定月 ※2	非含有証明書 ※3
 対応済み		<a href="#">ダウンロードはこちら</a>

### 中国 RoHS

中国 RoHS表 ※1※2										
Pb	Hg	Cd	Cr(VI)	PBBs	PBDEs	DBP	DIBP	BBP	DEHP	環境保護 使用期限
X	0	0	0	0	0	0	0	0	0	10

- ・“対応済み”や非含有の記載がされた商品であっても、流通在庫等で未対応品が混在する可能性があります。
- ・非含有品が必要な際は、弊社営業部門もしくは販売店へお問い合わせください。

[この製品のRoHS/REACH対応状況ページへ>](#)

## 注意事項・凡例

”対応済み”で記載される商品であっても、流通在庫等で未対応品が混在する可能性があります。  
非含有品が必要な際は、弊社営業部門もしくは販売店へお問い合わせください。

### ※1 対応状況

- ・  対応済み : EU RoHS指令（10物質）の非含有に対応した製品が提供可能な商品です。
- ・ 対応予定 : EU RoHS指令（10物質）の非含有に対応した製品に切り替える予定のある商品です。
- ・ 対応予定なし : EU RoHS指令（10物質）の非含有に非対応の商品で、対応品を出す予定はありません。
- ・ 調査・確認中 : EU RoHS指令（10物質）の非含有の対応状況を調査中または確認中の商品です。
- ・ 非該当品 : ライセンス料など無形物で、有害物質有無と関係のない商品です。

仕入先様の事情により、非含有部品としていたものが、含有品と判明した場合などやむを得ず変更することがあります。

\* EU RoHS指令（10物質）：

鉛(Pb) 1000ppm以下、水銀(Hg) 1000ppm以下、カドミウム(Cd) 100ppm以下、六価クロム(Cr(VI)) 1000ppm以下、  
ポリ臭化ビフェニル類(PBB) 1000ppm以下、ポリ臭化ジフェニルエーテル類(PBDE) 1000ppm以下、  
フタル酸ビス(2-エチルヘキシル) (DEHP)(別名：DOP) 1000ppm以下、フタル酸ブチルベンジル (BBP) 1000ppm以下、  
フタル酸ジブチル (DBP) 1000ppm以下、フタル酸ジイソブチル (DIBP) 1000ppm以下  
但し、RoHS指令で産業用監視および制御機器に対する適用除外項目は除く。  
フタル酸エステル類の4物質については閾値を超える意図的な使用がないことを確認しています。

### ※2 対応予定月

部品在庫の切り替え状況などにより、予定月が前後することがあります。

### ※3 非含有証明書ダウンロード

下記の非含有証明書をダウンロードすることができます。

- ・ EU RoHS指令（10物質）の非含有証明書
- ・ 49物質の非含有証明書（当社基準）

※ 本証明書は発行日時時点で非含有を証明するもので、過去に遡って非含有を証明するものではありません。

また、RoHS指令のフタル酸エステル類4物質の対応では、対応完了までの期間は出荷製品に未対応品が混在することから備考欄に  
対応日を記載しておりました。

既に当社にて対応品への在庫切替を完了していることから、特段のことがない限り、2022年1月12日より割愛しております。

## 規格認証/適合状況

UL認証	CSA認証	CEマーキング	CCC認証	電波法
Yes	Yes	Yes	N/A	N/A

LR型式承認 (イギリス 船舶規格)	DNV型式承認 (ノルウェー 船舶規格)	BV型式承認 (フランス 船舶規格)	KR型式承認 (韓国 船舶規格)	NK型式承認 (日本 船舶規格)	ABS型式承認 (アメリカ 船舶規格)
No	No	No	No	No	No

[この製品の規格認証/適合状況ページへ>](#)  
[その他の認証はこちらのページからご検索ください>](#)