

デジタルタイマ

H5CX-L8S-N



商品概要

Digital Timer, Economy Type, 1 tier, Transistor output, 100 to 240 VAC, 8-pin round socket

販売状況

2026/06/30 00:00 情報更新

販売状況	受注終了
受注終了日	2025年9月

推奨代替品の最新情報につきましては、当社Webサイト(www.fa.omron.co.jp)の「生産終了品/推奨代替品」をご覧ください。
在庫状況/標準価格の最新情報につきましては、当社Webサイト(www.fa.omron.co.jp)の「在庫状況/標準価格照会」をご覧ください。

詳細情報

Ratings/Performance

情報更新：2024/12/23

Rated supply voltage		100 to 240 VAC (50/60 Hz)
Operating voltage range		85 to 110% of rated supply voltage
Power consumption		Approx. 6.2 VA
Time ranges (Number of ranges)		10
Time ranges		0.001 to 9.999 s 0.01 to 99.99 s 0.1 to 999.9 s 1 to 9999 s 0.1 to 999.9 min 1 to 9999 min 0.1 to 999.9 h 1 to 9999 h 1 s to 99 min 59 s 1 min to 99 h 59 min
Input method		No-voltage input
No-voltage input	Solid state input	Short-circuit (ON) impedance: 1 kΩ max. (Leakage current (0 Ω): Approx. 12 mA) Short-circuit (ON) residual voltage: 3 V max. Open circuit impedance: 100 kΩ min. (The DC voltage must be 30 VDC max.)
	Contact input	Use contact which can adequately switch 5 mA at 10 V
	Applicable two-wire sensor	Leakage current: 1.5 mA max. Switching capacities: 5 mA min. Residual voltage: 3.0 VDC max. Operating voltage: 10 VDC
Output modes		A: Signal ON delay (I) A-1: Signal ON delay (II) A-2: Power ON delay (I) A-3: Power ON delay (II) b: Repeat cycle (I) b-1: Repeat cycle (II) d: Signal OFF delay E: Interval F: Cumulative Z: ON/OFF-duty adjustable flicker S: Stopwatch toff: Flicker OFF start (I) ton: Flicker ON start (I) toff-1: Flicker OFF start (II) ton-1: Flicker ON start (II)
Control output (Solid state output)		1 point (Transistor output) Mode: NPN open collector (SPST-NO) Switching capacities: 30 VDC max., 100 mA max. Residual voltage: 1.5 V max. (Capacity value: Approx. 1 V) Leakage current: 0.1 mA max.
Reset system		Power reset (depending on output mode)/Automatic reset (depending on output mode)/External reset/Manual reset

Power reset	Minimum power-opening time: 0.5 s (except for A-3, b1, F, ton-1 and toff-1 mode)
Timer mode	Elapsed time (UP) and remaining time (DOWN) (selectable)
Display method	7-segment negative transmissive LCD 4 digit
Character height	Present value: 12 mm (Red) Set value: 6 mm (green)
Key protect method	Key protect Switch
Memory backup method	EEP-ROM (number of writes: 100,000 min., that can store data for 10 years min.)
Ambient temperature (Operating)	-10 to 55 °C (with no freezing or condensation) When mount timer side by side: -10 to 50 °C (with no freezing or condensation)
Ambient temperature (Storage)	-25 to 70 °C (with no freezing or condensation)
Ambient humidity (Operating)	25 to 85 %
Accuracy of operating time	Power-ON start: $\pm 0.01\% \pm 0.05$ s max. (The values are based on the set value.) Signal start: $\pm 0.005\% \pm 3$ ms max. (The values are based on the set value. The value is applied for a minimum pulse width of 1 ms.)
Setting error	Power-ON start: $\pm 0.01\% \pm 0.05$ s max. (The values are based on the set value.) Signal start: $\pm 0.005\% \pm 3$ ms max. (The values are based on the set value. The value is applied for a minimum pulse width of 1 ms.)
Influence of voltage	Power-ON start: $\pm 0.01\% \pm 0.05$ s max. (The values are based on the set value.) Signal start: $\pm 0.005\% \pm 3$ ms max. (The values are based on the set value. The value is applied for a minimum pulse width of 1 ms.)
Influence of temperature	Power-ON start: $\pm 0.01\% \pm 0.05$ s max. (The values are based on the set value.) Signal start: $\pm 0.005\% \pm 3$ ms max. (The values are based on the set value. The value is applied for a minimum pulse width of 1 ms.)
Insulation resistance	Between current carrying terminals and exposed non-current carrying metal parts: 100 M Ω min. (at 500 VDC) Between non-continuous contacts: 100 M Ω min. (at 500 VDC)
Dielectric strength	Between current carrying metal parts and non-current carrying metal parts: 2000 VAC 50/60 Hz 1 min Between operating power circuit and input circuit: 2000 VAC 50/60 Hz 1 min Between control output, and power supply/input circuit: 2000 VAC 50/60 Hz 1 min Between non-continuous contacts: 1000 VAC 50/60 Hz 1 min
Impulse withstand voltage	Between power terminals: 5 kV Between current carrying terminals and exposed non-current carrying metal parts: 5 kV
Noise immunity	Between power terminals: ± 1.5 kV Between input terminals: ± 600 kV square-wave noise by noise simulator, pulse width: 100 ns/1 μ s, 1-ns rise

Static immunity	Mulfunction: 8 kV, Destruction: 15 kV
Vibration resistance	Destruction: 10 to 55 Hz, 0.75 mm single amplitude each in 3 directions for 2 h Malfunction: 10 to 55 Hz 0.35 mm single amplitude each in 3 directions for 10 min
Shock resistance	Destruction: 300 m/s ² , 3 times each in 3 axes each directions Malfunction: 100 m/s ² , 3 times each in 6 directions
Degree of protection	Only panel surface: IEC IP66, UL508 Type 4X (indoors) (when using the Y92S-29 Waterproof Packing and Y92F-30 Flush Mounting Adapter)
Mounting method	Flush mounting / Surface mounting
External connection method	8-pin round socket
Case color	Black (Munsell N1.5)
Applicable socket	P2CF-08, P2CF-08-E, P3G-08
Accessory (sold separately)	Soft Cover: Y92A-48F1 Hard Cover: Y92A-48 Flush mounting adapter: Y92F-30/Y92F-45/Y92F-38 Waterproof packing: Y92S-29 Replacement Front Panel: Y92P-CXT4S/Y92P-CXT4G/Y92P-CXT4B
Weight	Main Unit: Approx. 115 g

Dimensions

情報更新：2024/12/23

H5CX-L8□-N (Flush Mounting/Surface Mounting Models)

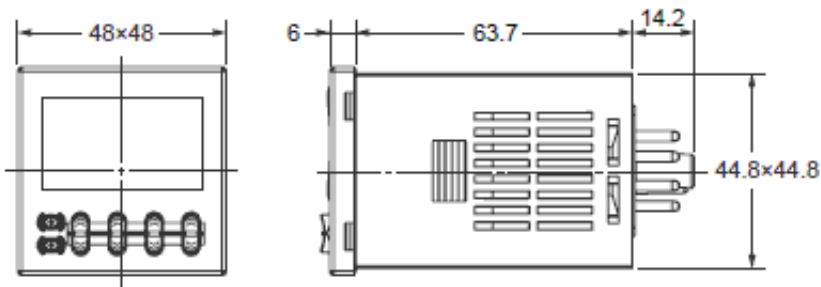

Dimensions with Flush Mounting Adapter

H5CX-L8□-N (Adapter and Waterproof Packing Ordered Separately)

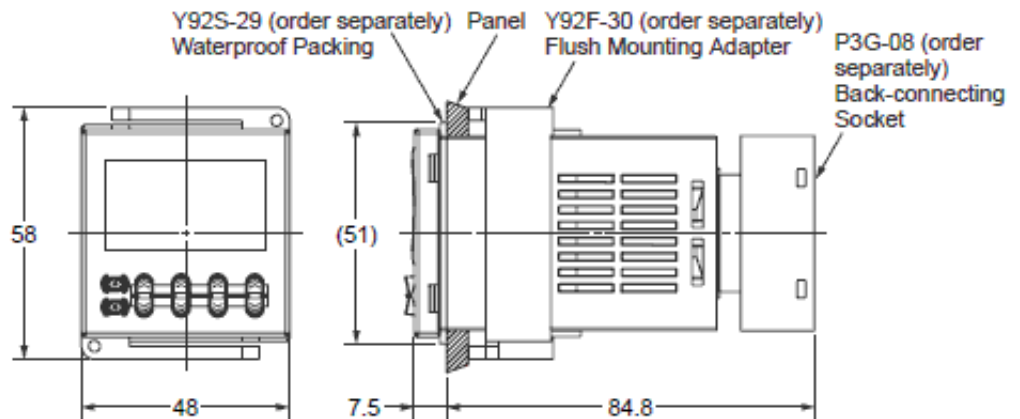

Terminal arrangement

情報更新：2024/12/23

H5CX-L8S-N/-L8SD-N

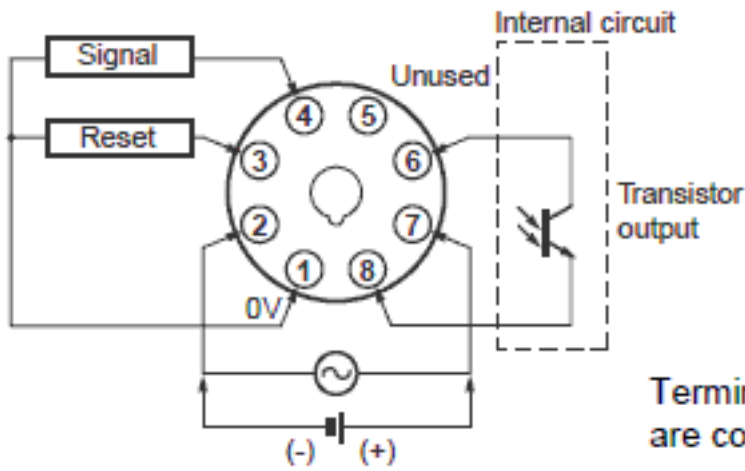

Terminals 1 and 2 of the H5CX-L8SD-N are connected internally.

Input connections

情報更新：2024/12/23

No-voltage Inputs (NPN Inputs)

Open Collector

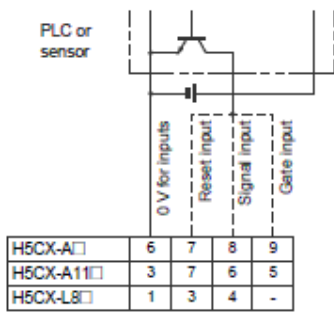

Note: Operate with transistor ON

Voltage Output

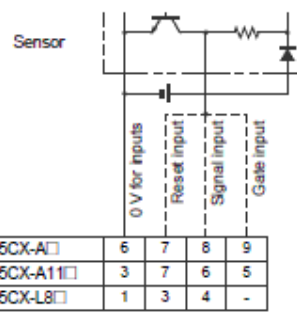

Note: Operate with transistor ON

Contact Input

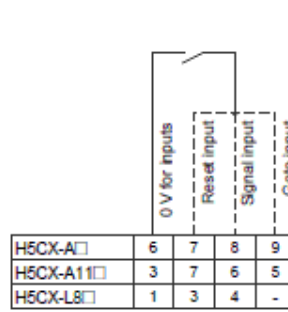

Note: Operate with relay ON

DC Two-wire Sensor

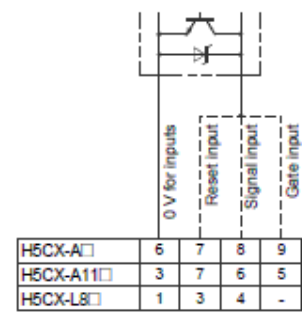

Note: Operate with transistor ON

No-voltage Input Signal Levels

No-contact input	Short-circuit level Transistor ON
	<ul style="list-style-type: none"> Residual voltage: 3 V max. Impedance when ON: 1 kΩ max. (The leakage current is approx. 12 mA when the impedance is 0 Ω.)
Contact input	Open level Transistor OFF
	<ul style="list-style-type: none"> Impedance when OFF: 100 kΩ min.

Note: The DC voltage must be 30 VDC max.

Applicable Two-wire Sensor

- Leakage current: 1.5 mA max.
- Switching capacity: 5 mA min.
- Residual voltage: 3.0 VDC max.
- Operating voltage: 10 VDC



Operating chart

情報更新：2024/12/23

Timing Charts
Operating Procedures for Timer Function

Models without Instantaneous Contact Outputs

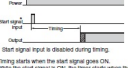
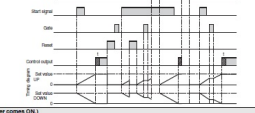
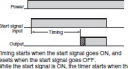
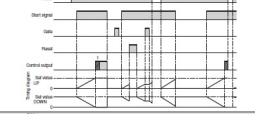
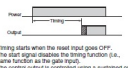
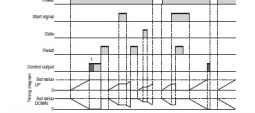
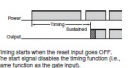
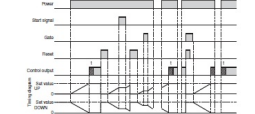
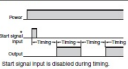
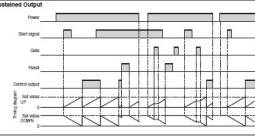
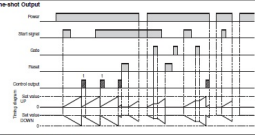
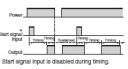
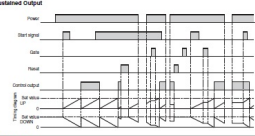
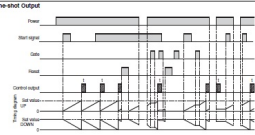
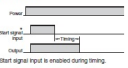
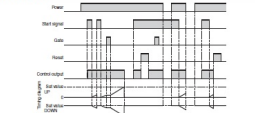
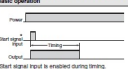
The gate input is not included in the H5CX-L8S-N models. 

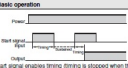
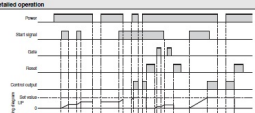
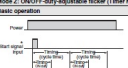
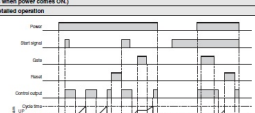
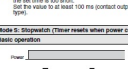
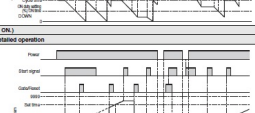
Mode	Basic operation	Detailed operation
Mode 0: Signal ON delay 1 (Timer resets when power comes ON)	<p>Basic operation</p>  <p>Start signal input is disabled during timing.</p> <p>Timing starts when the start signal gives ON, and resets when the start signal gives OFF. The control output is controlled with a sustained or one-shot time period.</p> <p>Note: Output is instantaneous when setting is 0.</p>	<p>Detailed operation</p> 
Mode A-1: Signal ON delay 2 (Timer resets when power comes ON)	<p>Basic operation</p>  <p>Timing starts when the start signal gives ON, and resets when the start signal gives OFF. The control output is controlled with a sustained or one-shot time period.</p> <p>Note: Output is instantaneous when setting is 0.</p>	<p>Detailed operation</p> 
Mode A-2: Power ON delay 1 (Timer resets when power comes ON)	<p>Basic operation</p>  <p>Timing starts when the start signal gives OFF. The start signal disables the timing function (i.e., same function as the gate input). The control output is controlled with a sustained or one-shot time period.</p> <p>Note: Output is instantaneous when setting is 0.</p>	<p>Detailed operation</p> 
Mode A-3: Power ON delay 2 (Timer does not reset when power comes ON)	<p>Basic operation</p>  <p>Timing starts when the start signal gives OFF. The start signal disables the timing function (i.e., same function as the gate input). The control output is controlled with a sustained or one-shot time period.</p> <p>Note: Output is instantaneous when setting is 0.</p>	<p>Detailed operation</p> 
Mode 0: Repeat cycle 1 (Timer resets when power comes ON)	<p>Basic operation</p>  <p>Start signal input is disabled during timing.</p> <p>Timing starts when the start signal gives ON. The status of the control output is released when time is up (OFF or ON).</p> <p>Note: Normal output operation will not be possible if the set time is less than 100 ms (pulsed output type).</p>	<p>Detailed operation</p> <p>Sustained Output</p>  <p>One-shot Output</p> 
Mode B-1: Repeat cycle 2 (Timer does not reset when power comes ON)	<p>Basic operation</p>  <p>Start signal input is disabled during timing.</p> <p>Timing starts when the start signal gives ON. The control output is latched ON when time is up. While the start signal is ON, the timer starts when the power comes ON or when the start signal gives OFF.</p> <p>Note: Normal output operation will not be possible if the set time is less than 100 ms (pulsed output type).</p>	<p>Detailed operation</p> <p>Sustained Output</p>  <p>One-shot Output</p> 
Mode 0: Signal OFF delay (Timer resets when power comes ON)	<p>Basic operation</p>  <p>Start signal input is enabled during timing.</p> <p>The control output is ON when the start signal is ON (except when the power is OFF or the reset is ON). The timer starts when the time is up.</p> <p>Note: Output functions only during start signal input when setting is 0.</p>	<p>Detailed operation</p> 
Mode 0: Interval (Timer resets when power comes ON)	<p>Basic operation</p>  <p>Start signal input is enabled during timing.</p> <p>Timing starts when the start signal gives ON. The timer starts when the time is up. While the start signal is ON, the timer starts when the power comes ON, the start signal gives ON, or the start signal gives OFF.</p> <p>Note: Output is disabled when the setting is 0.</p>	<p>Detailed operation</p> 
Mode F: Cumulative (Timer does not reset when power comes ON)	<p>Basic operation</p>  <p>Start signal enables timing. Timing is stopped when the start signal gives OFF or when the power is OFF. A sustained control output is used.</p> <p>Note: Output is instantaneous when setting is 0. When the H5CX is used with power start, there will be a timer error approximately 100 ms each time the H5CX is started. Only due to the characteristics of the internal circuitry, use the H5CX with signal start if timer accuracy is required.</p>	<p>Detailed operation</p> 
Mode 2: ON/OFF duty-adjustable timer (Timer resets when power comes ON)	<p>Basic operation</p>  <p>Start signal input is disabled during timing.</p> <p>Timing starts when the start signal gives ON. The status of the control output is released when time is up (ON or OFF).</p> <p>Note: Normal output operation will not be possible if the set time is less than 100 ms (pulsed output type).</p>	<p>Detailed operation</p> 
Mode 0: Stop/reset (Timer resets when power comes ON)	<p>Basic operation</p>  <p>The signal starts and stops timing. The stop/reset and timing is continued if the start or gate input is received during timing operation. The timer starts if the start or gate input is received when the timing operation is active.</p> <p>Note: Output is instantaneous when setting is 0.</p>	<p>Detailed operation</p> 

Timing Charts

Operating Procedures for Twin Timer Function

Models without Instantaneous Contact Outputs

The gate input is not included in the H5CX-L8□ models.

Mode toff: Flicker OFF start 1 (Timer resets when power comes ON.)	
Basic operation	Detailed operation
<p>* Start signal input is disabled during timing.</p> <p>Timing starts when the start signal goes ON. The status of the control output is reversed when time is up (OFF at start). While the start signal is ON, the timer starts when the power comes ON or when the reset input goes OFF.</p> <p>Note: Normal output operation will not be possible if the set time is too short. Set the value to at least 100 ms (contact output type).</p>	
Mode ton: Flicker OFF start 1 (Timer resets when power comes ON.)	
Basic operation	Detailed operation
<p>* Start signal input is disabled during timing.</p> <p>Timing starts when the start signal goes ON. The status of the control output is reversed when time is up (ON at start). While the start signal is ON, the timer starts when the power comes ON or when the reset input goes OFF.</p> <p>Note: Normal output operation will not be possible if the set time is too short. Set the value to at least 100 ms (contact output type).</p>	
Mode toff-1: Flicker OFF start 2 (Timer does not reset when power comes ON.)	
Basic operation	Detailed operation
<p>* Start signal input is disabled during timing.</p> <p>Timing starts when the start signal goes ON. The status of the control output is reversed when time is up (OFF at start). While the start signal is ON, the timer starts when the power comes ON or when the reset input goes OFF.</p> <p>Note: Normal output operation will not be possible if the set time is too short. Set the value to at least 100 ms (contact output type).</p>	
Mode ton-1: Flicker ON start 2 (Timer does not reset when power comes ON.)	
Basic operation	Detailed operation
<p>* Start signal input is disabled during timing.</p> <p>Timing starts when the start signal goes ON. The status of the control output is reversed when time is up (ON at start). While the start signal is ON, the timer starts when the power comes ON or when the reset input goes OFF.</p> <p>Note: Normal output operation will not be possible if the set time is too short. Set the value to at least 100 ms (contact output type).</p>	

RoHS/REACH対応状況

情報更新：2026/6/17

H5CX-L8S-NのRoHS対応状況については、営業部門もしくは販売店にお問い合わせください。

注意事項・凡例

”対応済み”で記載される商品であっても、流通在庫等で未対応品が混在する可能性があります。
非含有品が必要な際は、弊社営業部門もしくは販売店へお問い合わせください。

※1 対応状況

- ・  対応済み : EU RoHS指令（10物質）の非含有に対応した製品が提供可能な商品です。
- ・ 対応予定 : EU RoHS指令（10物質）の非含有に対応した製品に切り替える予定のある商品です。
- ・ 対応予定なし : EU RoHS指令（10物質）の非含有に非対応の商品で、対応品を出す予定はありません。
- ・ 調査・確認中 : EU RoHS指令（10物質）の非含有の対応状況を調査中または確認中の商品です。
- ・ 非該当品 : ライセンス料など無形物で、有害物質有無と関係のない商品です。

仕入先様の事情により、非含有部品としていたものが、含有品と判明した場合などやむを得ず変更することがあります。

* EU RoHS指令（10物質）：

鉛(Pb) 1000ppm以下、水銀(Hg) 1000ppm以下、カドミウム(Cd) 100ppm以下、六価クロム(Cr(VI)) 1000ppm以下、
ポリ臭化ビフェニル類(PBB) 1000ppm以下、ポリ臭化ジフェニルエーテル類(PBDE) 1000ppm以下、
フタル酸ビス(2-エチルヘキシル) (DEHP)(別名：DOP) 1000ppm以下、フタル酸ブチルベンジル (BBP) 1000ppm以下、
フタル酸ジブチル (DBP) 1000ppm以下、フタル酸ジイソブチル (DIBP) 1000ppm以下
但し、RoHS指令で産業用監視および制御機器に対する適用除外項目は除く。
フタル酸エステル類の4物質については閾値を超える意図的な使用がないことを確認しています。

※2 対応予定月

部品在庫の切り替え状況などにより、予定月が前後することがあります。

※3 非含有証明書ダウンロード

下記の非含有証明書をダウンロードすることができます。

- ・ EU RoHS指令（10物質）の非含有証明書
- ・ 49物質の非含有証明書（当社基準）

※ 本証明書は発行日時時点で非含有を証明するもので、過去に遡って非含有を証明するものではありません。

また、RoHS指令のフタル酸エステル類4物質の対応では、対応完了までの期間は出荷製品に未対応品が混在することから備考欄に
対応日を記載しておりました。

既に当社にて対応品への在庫切替を完了していることから、特段のことがない限り、2022年1月12日より割愛しております。

規格認証/適合状況

UL認証	CSA認証	CEマーキング適合	CCC認証	電波法
Yes	Yes	Yes	Yes	N/A

LR型式承認 (イギリス 船舶規格)	DNV型式承認 (ノルウェー 船舶規格)	BV型式承認 (フランス 船舶規格)	KR型式承認 (韓国 船舶規格)	NK型式承認 (日本 船舶規格)	ABS型式承認 (アメリカ 船舶規格)
No	No	No	No	No	No

[この製品の規格認証/適合状況ページへ>](#)
[その他の認証はこちらのページからご検索ください>](#)