

デジタルタイマ

# H5CC-AUD



## 商品概要

Digital Timer, Standard type, Screw terminals, One stage, Contact output (time-limit SPDT) + transistor output (time-limit SPST) (with external power supply), 12 to 48 VDC/24 VAC

## 販売状況

2026/04/01 00:00 情報更新

販売状況	販売中
機種区分	標準在庫機種
標準価格(税別)	¥ 37,000

推奨代替品の最新情報につきましては、当社Webサイト([www.fa.omron.co.jp](http://www.fa.omron.co.jp))の「生産終了品/推奨代替品」をご覧ください。  
在庫状況/標準価格の最新情報につきましては、当社Webサイト([www.fa.omron.co.jp](http://www.fa.omron.co.jp))の「在庫状況/標準価格照会」をご覧ください。

# 詳細情報

## Ratings/Performance

情報更新：2025/06/19

Rated supply voltage		24 VAC 50/60 Hz 12 to 48 VDC
Operating voltage range		85 to 110% of rated power supply voltage (90 to 110% at 12 to 48 VDC)
External power supply		12 VDC $\pm$ 10% 100 mA
Power consumption		Approx. 5.4 VA/Approx. 3.2 W
Time ranges (Number of ranges)		10
Time ranges		0.001 to 999.999 s 0.01 to 9999.99 s 0.1 to 99999.9 s 1 to 999999 s 1 s to 99 h 59 min 59 s 0.1 to 99999.9 min 1 to 999999 min 1 min to 9999 h 59 min 0.1 to 99999.9 h 1 to 999999 h
Input method		No-voltage (NPN)/Voltage (PNP) input (selectable)
No-voltage input	Solid state input	Short-circuit (ON) impedance: 1 k $\Omega$ max. (Leakage current (0 $\Omega$ ): Approx. 12 mA) Short-circuit (ON) residual voltage: 3 V max. Open circuit impedance: 100 k $\Omega$ min. (The DC voltage must be 30 VDC max.)
	Contact input	Use contact which can adequately switch 5 mA at 10 V
	Applicable two-wire sensor	Leakage current: 1.5 mA max. Switching capacities: 5 mA min. Residual voltage: 3.0 VDC max. Operating voltage: 10 VDC
Voltage input		High level: 4.5 to 30 VDC Low level: 0 to 2 VDC (Input resistance 4.7 k $\Omega$ )
Output modes		A: Signal ON delay ( I ) A-1: Signal ON delay ( II ) A-2: Power ON delay ( I ) A-3: Power ON delay ( II ) b: Repeat cycle ( I ) b-1: Repeat cycle ( II ) b-5: One-shot flicker C: Signal ON/OFF delay ( I ) d: Signal OFF delay ( I ) E: Interval F: Cumulative G: Signal ON/OFF delay ( II ) H: Signal OFF delay ( II ) Z: ON/OFF-duty adjustable flicker S: Stopwatch toff: Flicker OFF start ( I ) ton: Flicker ON start ( I ) toff-1: Flicker OFF start ( II ) ton-1: Flicker ON start ( II )

Control output (Contact output)	Time-limit SPDT Switching capacities: 5 A at 250 VAC/30 VDC, resistive load (cos =1) Minimum applicable load: 10 mA at 5 VDC (failure level: P Reference value) Contact material: AgSnIn
Control output (Solid state output)	1 point (Transistor output) Mode: NPN open collector (SPST-NO) Switching capacities: 30 VDC max., 100 mA max. Residual voltage: 1.5 V max. (Capacity value: Approx. 1 V) Leakage current: 0.1 mA max.
Reset system	Power reset (depending on output mode)/External reset/Manual reset/Automatic reset (depending on output mode)
Power reset	Minimum power-opening time: 1 s (except for A-3, b-1, F, ton-1, and toff-1 mode)
Timer mode	Elapsed time (UP) and remaining time (DOWN) (selectable)
Display method	7-segment negative transmissive LCD 6 digit
Character height	Present value: 10 mm (White) Set value: 6 mm (Green)
Key protect method	Key protect Switch
Memory backup method	Non-volatile memory (number of writes: 100,000 min., that can store data for 10 years min.)
Ambient temperature (Operating)	-10 to 55 °C (with no freezing or condensation) When mount timer side by side: -10 to 50 °C (with no freezing or condensation)
Ambient temperature (Storage)	-25 to 70 °C (with no freezing or condensation)
Ambient humidity (Operating)	25 to 85 %
Accuracy of operating time	Power-ON start: $\pm 0.01\% \pm 0.05$ s max. (The values are based on the set value.) Signal start: $\pm 0.005\% \pm 0.03$ s max. (The values are based on the set value.)
Setting error	Power-ON start: $\pm 0.01\% \pm 0.05$ s max. (The values are based on the set value.) Signal start: $\pm 0.005\% \pm 0.03$ s max. (The values are based on the set value.)
Influence of voltage	Power-ON start: $\pm 0.01\% \pm 0.05$ s max. (The values are based on the set value.) Signal start: $\pm 0.005\% \pm 0.03$ s max. (The values are based on the set value.)
Influence of temperature	Power-ON start: $\pm 0.01\% \pm 0.05$ s max. (The values are based on the set value.) Signal start: $\pm 0.005\% \pm 0.03$ s max. (The values are based on the set value.)
Insulation resistance	Between current carrying terminals and exposed non-current carrying metal parts: 100 M $\Omega$ min. (at 500 VDC) Between non-continuous contacts: 100 M $\Omega$ min. (at 500 VDC)
Dielectric strength	Between conductor terminal and operating section: 2900 VAC 50/60 Hz 1 min Between operating power circuit and input circuit: 1500 VAC 50/60 Hz 1 min

	Between control output, and power supply/input circuit: 2000 VAC 50/60 Hz 1 min Between non-continuous contacts: 1000 VAC 50/60 Hz 1 min
Impulse withstand voltage	Between power terminals: 1.0 kV Between conductor terminal and operating section: 7.4 kV
Noise immunity	square-wave noise by noise simulator, pulse width: 100 ns/1 μs, 1-ns rise
Static immunity	Multifunction: 8 kV, Destruction: 15 kV
Vibration resistance	Destruction: 10 to 55 Hz, 0.75 mm single amplitude each in 3 directions for 2 h Malfunction: 10 to 55 Hz 0.35 mm single amplitude each in 3 directions for 10 min
Shock resistance	Destruction: 300 m/s <sup>2</sup> , 3 times each in 3 axes each directions Malfunction: 100 m/s <sup>2</sup> , 3 times each in 3 axes each directions
Life expectancy	Mechanical: 10 million operations min. (under no load at 1,800 operations/h, 23 °C) Electrical: 100,000 operations min. (5 A at 250 VAC resistive load at 1800 operations/h, 23 °C)
Degree of protection	Only panel surface: IEC IP66 for panel surface only and when Y92S-P6 Waterproof Packing is used
Mounting method	Flush mounting
External connection method	Screw terminal
Case color	Black (Munsell N1.5)
Attachment	Flush mounting adapter, waterproof packing, terminal covers
Accessory (sold separately)	Soft Cover: Y92A-48F1 Hard Cover: Y92A-48 Flush mounting adapter: Y92F-30/Y92F-45/Y92F-38 Waterproof packing: Y92S-P6
Weight	Main Unit: Approx. 115 g

## Dimensions

情報更新：2025/06/19

### Digital Timers

#### H5CC-A/-AD/-AS/-ASD/-AU/-AUD/-AWS (Flush Mounting Models)

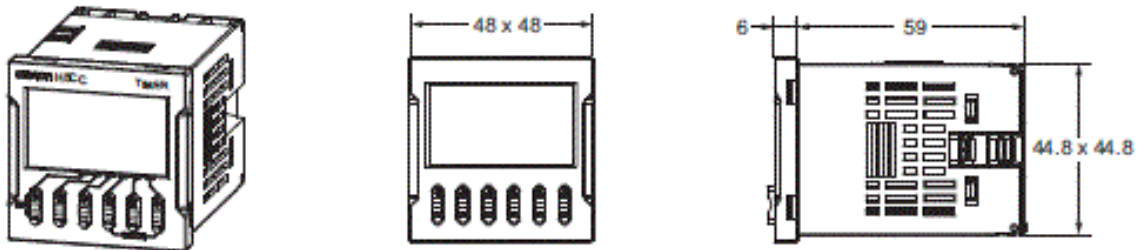

### Dimensions with Flush Mounting Adapter

#### H5CC-A/-AD/-AS/-ASD/-AU/-AUD/-AWS (Flush Mounting Models) (Provided with Adapter and Waterproof Packing)

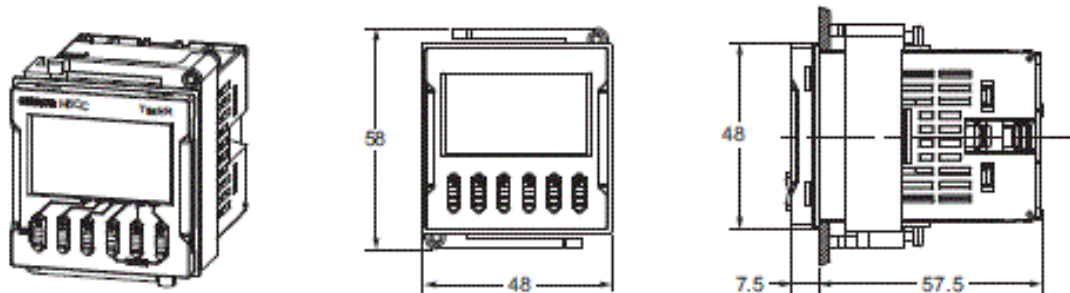

# Terminal arrangement

情報更新：2025/06/19

## H5CC-AU/AUD

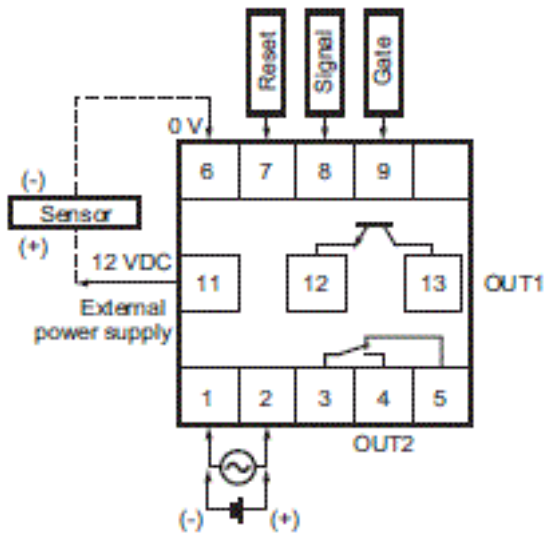

# Input connections

情報更新：2025/06/19

## Input Connections

The inputs of the H5CC are no-voltage (short-circuit or open) inputs or voltage inputs. (Reverse connection is not possible because there is polarity.)  
(The inputs of the H5CC-A11F/L8□ are no-voltage inputs only. The H5CC-L8E□ does not have an input.)

### No-voltage Inputs (NPN Inputs)

#### Open Collector

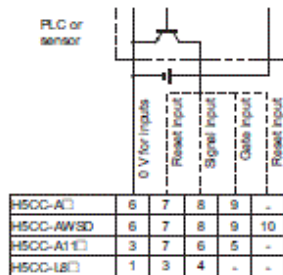

Note: Operate with transistor ON

#### Voltage Output



Note: Operate with transistor ON

#### Contact Input

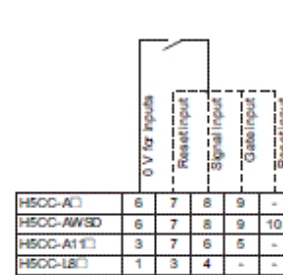

Note: Operate with relay ON

#### DC Two-wire Sensor



Note: Operate with transistor ON

### No-voltage Input Signal Levels

No-contact input	Short-circuit level (Transistor ON)
	<ul style="list-style-type: none"> <li>Residual voltage: 3.0 VDC max. (1.0 VDC max. for the H5CC-A11F)</li> <li>Impedance when ON: 1 kΩ max. (The leakage current is approx. 12 mA when the impedance is 0 Ω.) (Approx. 1 mA for the H5CC-A11F)</li> </ul>
	Open level (transistor OFF)
	<ul style="list-style-type: none"> <li>OFF impedance: 100 kΩ min.</li> </ul>
Contact input	Use contacts which can adequately switch 5 mA at 10 V.

\* The DC voltage must be 30 VDC max.

#### Applicable Two-wire Sensor

- Leakage current: 1.5 mA max.
- Switching capacity: 5 mA min.
- Residual voltage: 3.0 VDC max. (1.0 VDC max. for the H5CC-A11F)
- Operating voltage: 10 VDC

Note: When an AC input signal will be input to signal, reset, and gate inputs. Input the signal via a relay, etc. because AC input cannot be input directly.

(Example)

Connection example



### Voltage Inputs (PNP Inputs) Note: The inputs of the H5CC-A11F/L8□ are no-voltage inputs only.

#### No-contact Input (NPN Transistor)

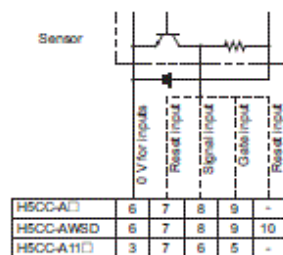

Note: Operate with transistor OFF

#### No-contact Input (PNP Transistor)

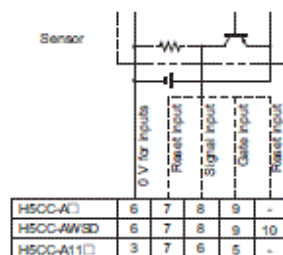

Note: Operate with transistor ON

#### Contact Input

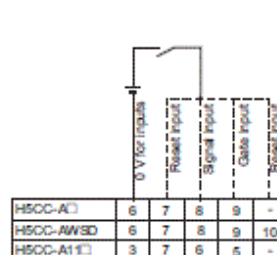

Note: Operate with relay ON

### Voltage Input Signal Levels

High level (Input ON): 4.5 to 30 VDC	* The DC voltage must be 30 VDC max. * Input resistance: Approx. 4.7 kΩ
Low level (Input OFF): 0 to 2 VDC	

# Operating chart

情報更新：2025/06/19





## Operating Procedures for Twin Timer Function

### Models Other than the H5CC-L8E□

The gate input is not included in the H5CC-L8□ models.

Mode toff: Flicker OFF start I (Timer resets when power comes ON.)	
Basic operation	Detailed operation
<p>* Start signal input is disabled during timing.</p> <p>Timing starts when the start signal goes ON. The status of the control output is reversed when time is up (OFF at start). While the start signal is ON, the Timer starts when the power comes ON or when the reset input goes OFF.</p> <p><b>Note:</b> Normal output operation will not be possible if the set time is too short. Set the ON time and OFF time to at least 100 ms (contact output type).</p>	
Mode ton: Flicker ON start I (Timer resets when power comes ON.)	
Basic operation	Detailed operation
<p>* Start signal input is disabled during timing.</p> <p>Timing starts when the start signal goes ON. The status of the control output is reversed when time is up (ON at start). While the start signal is ON, the Timer starts when the power comes ON or when the reset input goes OFF.</p> <p><b>Note:</b> Normal output operation will not be possible if the set time is too short. Set the ON time and OFF time to at least 100 ms (contact output type).</p>	
Mode toff-1: Flicker OFF start II (Timer does not reset when power comes ON.)	
Basic operation	Detailed operation
<p>* Start signal input is disabled during timing.</p> <p>Timing starts when the start signal goes ON. The status of the control output is reversed when time is up (OFF at start). While the start signal is ON, the Timer starts when the power comes ON or when the reset input goes OFF.</p> <p><b>Note:</b> Normal output operation will not be possible if the set time is too short. Set the ON time and OFF time to at least 100 ms (contact output type).</p>	
Mode ton-1: Flicker ON start II (Timer does not reset when power comes ON.)	
Basic operation	Detailed operation
<p>* Start signal input is disabled during timing.</p> <p>Timing starts when the start signal goes ON. The status of the control output is reversed when time is up (ON at start). While the start signal is ON, the Timer starts when the power comes ON or when the reset input goes OFF.</p> <p><b>Note:</b> Normal output operation will not be possible if the set time is too short. Set the ON time and OFF time to at least 100 ms (contact output type).</p>	

# Electrical life

情報更新：2025/06/19

## Electrical Life Test Curve (Reference Values)

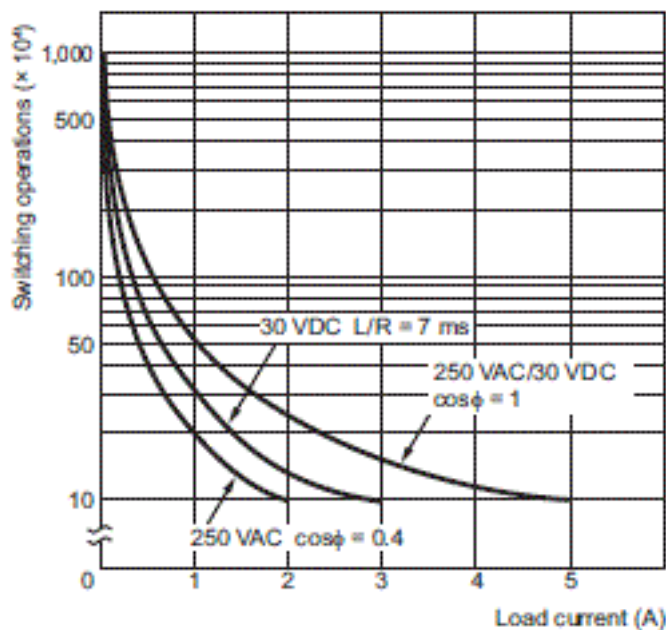

A maximum current of 0.15 A can be switched at 125 VDC ( $\cos\phi = 1$ ) and a maximum current of 0.1 A can be switched if L/R is 7 ms. In both cases, a life of 100,000 operations can be expected.

## RoHS/REACH対応状況

情報更新：2026/4/01

### EU RoHS

対応状況 ※1	対応予定月 ※2	非含有証明書 ※3
 対応済み		<a href="#">ダウンロードはこちら</a>

### 中国 RoHS

中国 RoHS表 ※1※2										
Pb	Hg	Cd	Cr(VI)	PBBs	PBDEs	DBP	DIBP	BBP	DEHP	環境保護 使用期限
X	0	0	0	0	0	0	0	0	0	10

- ・“対応済み”や非含有の記載がされた商品であっても、流通在庫等で未対応品が混在する可能性があります。
- ・非含有品が必要な際は、弊社営業部門もしくは販売店へお問い合わせください。

[この製品のRoHS/REACH対応状況ページへ>](#)

## 注意事項・凡例

”対応済み”で記載される商品であっても、流通在庫等で未対応品が混在する可能性があります。  
非含有品が必要な際は、弊社営業部門もしくは販売店へお問い合わせください。

### ※1 対応状況

- ・  対応済み : EU RoHS指令（10物質）の非含有に対応した製品が提供可能な商品です。
- ・ 対応予定 : EU RoHS指令（10物質）の非含有に対応した製品に切り替える予定のある商品です。
- ・ 対応予定なし : EU RoHS指令（10物質）の非含有に非対応の商品で、対応品を出す予定はありません。
- ・ 調査・確認中 : EU RoHS指令（10物質）の非含有の対応状況を調査中または確認中の商品です。
- ・ 非該当品 : ライセンス料など無形物で、有害物質有無と関係のない商品です。

仕入先様の事情により、非含有部品としていたものが、含有品と判明した場合などやむを得ず変更することがあります。

\* EU RoHS指令（10物質）：

鉛(Pb) 1000ppm以下、水銀(Hg) 1000ppm以下、カドミウム(Cd) 100ppm以下、六価クロム(Cr(VI)) 1000ppm以下、  
ポリ臭化ビフェニル類(PBB) 1000ppm以下、ポリ臭化ジフェニルエーテル類(PBDE) 1000ppm以下、  
フタル酸ビス(2-エチルヘキシル) (DEHP)(別名：DOP) 1000ppm以下、フタル酸ブチルベンジル (BBP) 1000ppm以下、  
フタル酸ジブチル (DBP) 1000ppm以下、フタル酸ジイソブチル (DIBP) 1000ppm以下  
但し、RoHS指令で産業用監視および制御機器に対する適用除外項目は除く。  
フタル酸エステル類の4物質については閾値を超える意図的な使用がないことを確認しています。

### ※2 対応予定月

部品在庫の切り替え状況などにより、予定月が前後することがあります。

### ※3 非含有証明書ダウンロード

下記の非含有証明書をダウンロードすることができます。

- ・ EU RoHS指令（10物質）の非含有証明書
- ・ 49物質の非含有証明書（当社基準）

※ 本証明書は発行日時時点で非含有を証明するもので、過去に遡って非含有を証明するものではありません。

また、RoHS指令のフタル酸エステル類4物質の対応では、対応完了までの期間は出荷製品に未対応品が混在することから備考欄に  
対応日を記載しておりました。

既に当社にて対応品への在庫切替を完了していることから、特段のことがない限り、2022年1月12日より割愛しております。

## 規格認証/適合状況

UL認証	CSA認証	CEマーキング	CCC認証	電波法
Yes	Yes	Yes	Yes	N/A

LR型式承認 (イギリス 船舶規格)	DNV型式承認 (ノルウェー 船舶規格)	BV型式承認 (フランス 船舶規格)	KR型式承認 (韓国 船舶規格)	NK型式承認 (日本 船舶規格)	ABS型式承認 (アメリカ 船舶規格)
No	No	No	No	No	No

[この製品の規格認証/適合状況ページへ>](#)  
[その他の認証はこちらのページからご検索ください>](#)