

温度調節器（デジタル調節計）（22.5mm幅DINレール取り付けタイプ）

E5DC-QX2ABM-000



商品概要

Digital Temperature Controller, 22.5 mm wide, Voltage output (for driving SSR), Auxiliary output: 2, Power supply voltage: 100 to 240 VAC, Push-In Plus terminal block model, Universal inputs

販売状況

2026/06/25 00:00 情報更新

販売状況	販売中
機種区分	標準在庫機種
標準価格(税別)	¥ 25,500

推奨代替品の最新情報につきましては、当社Webサイト(www.fa.omron.co.jp)の「生産終了品/推奨代替品」をご覧ください。
在庫状況/標準価格の最新情報につきましては、当社Webサイト(www.fa.omron.co.jp)の「在庫状況/標準価格照会」をご覧ください。

詳細情報

Ratings / Performance

情報更新：2025/11/04

Ratings

Shape	22.5 mm wide	
Fixed/Programmable	Fixed	
Power supply voltage	100 to 240 VAC (50/60 Hz)	
Allowable voltage variable range	85 to 110% of the power supply voltage	
Power consumption	4.9 VA max. (at 100 to 240 VAC)	
Input	Number of input points	1 point
	Temperature input	Thermocouple: K, J, T, E, L, U, N, R, S, B, C/W, PLII Platinum resistance thermometer: Pt100, JPt100 Infrared Thermosensor (ES1B): 10 to 70 °C, 60 to 120 °C, 115 to 165 °C, 140 to 260 °C
	Analog input	4 to 20 mA or 0 to 20 mA
	Input impedance	Current input: 150 Ω max., voltage input: 1 MΩ min. (Applicable when connecting 1:1 to ES2-HB-N/THB-N.)
Control method	ON/OFF control or 2-PID control (with auto-tuning)	
Control output	Number of total control output	1 point
	Control output 1	Voltage output (for driving SSR)
	Control output 2	None
	Voltage output (for driving SSR)	1 point 12 VDC ±20%, Maximum load current: 21 mA, PNP, with short-circuit protection circuit
Auxiliary output	Number of total auxiliary output	2 point
	Relay output	SPST-NO relay outputs: 250 VAC, 2 A (resistive load), Electrical life: 100,000 operations, Minimum applicable load: 10 mA at 5 V (reference value)
Setting method	Digital setting using front panel keys (with protection function)	
Indication method	11-segment digital display and individual indicators	
Multi SP functions	Up to eight set points (SP0 to SP7) can be saved and selected using key operations.	
Sampling period	50 ms	
Hysteresis	Temperature input: 0.1 to 999.9 °C or °F (in units of 0.1 °C or °F) Analog input: 0.01 to 99.99% FS (in units of 0.01% FS)	

Proportional band		Temperature input: 0.1 to 999.9 °C or °F (in units of 0.1 °C or °F) Analog input: 0.1 to 999.9% FS (in units of 0.1% FS)
Integral time		0 to 9999 s (in units of 1 s), 0.0 to 999.9 s (in units of 0.1 s)
Derivative time		0 to 9999 s (in units of 1 s), 0.0 to 999.9 s (in units of 0.1 s)
for cooling	Proportional band (P)	Temperature input: 0.1 to 999.9 °C or °F (in units of 0.1 °C or °F) Analog input: 0.1 to 999.9% FS (in units of 0.1% FS)
	Integral time (I)	0 to 9999 s (in units of 1 s), 0.0 to 999.9 s (in units of 0.1 s)
	Derivative time (D)	0 to 9999 s (in units of 1 s), 0.0 to 999.9 s (in units of 0.1 s)
Control period		0.1 s, 0.2 s, 0.5 s, 1 to 99 s (in units of 1 s)
Manual reset value		0.0% to 100.0% (in units of 0.1%)
Insulation resistance		Between charged terminals and exposed uncharged parts: 20 MΩ min. (500 VDC) Between current-carrying terminals: 20 MΩ min. (500 VDC) Between non-continuous contacts: 20 MΩ min. (500 VDC)
Dielectric strength		3,000 VAC 50/60 Hz 1 min (Between current-carrying terminals of different polarity)
Vibration resistance		Destruction: 10 to 55 Hz, 20 m/s ² for 2 h each in X, Y, and Z directions Malfunction: 10 to 55 Hz, 20 m/s ² for 10 min each in X, Y, and Z directions
Shock resistance		Destruction: 300 m/s ² , 3 times each in X, Y, and Z directions Malfunction: 100 m/s ² , 3 times each in X, Y, and Z directions
Ambient temperature (Operating)		-10 to 55 °C (with no freezing or condensation) For 3-year warranty with standard mounting: -10 to 50 °C (with no freezing or condensation)
Ambient temperature (Storage)		-25 to 65 °C (with no freezing or condensation)
Ambient humidity (Operating)		25 to 85 %
Altitude		2000 m max.
Degree of protection		Main unit: IP20, Terminal unit: IP00
Memory protection		Non-volatile memory (number of writes: 1,000,000)
Case color		Black (N1.5)
Terminal type		Push-In Plus Terminal Block
Accessories		Two of Instruction Manual, One of Compliance information sheet, One of Connector Cover

Weight	Main Unit: Approx. 80 g Models with Push-In Plus Terminal Unit: Approx. 40 g
Sold separately	Push-In Plus Terminal Block Unit: E5DC-SCT1B USB Serial Conversion Cable: E58-CIFQ2 Communications Conversion Cable: E58-CIFQ2-E Mounting adapter: Y92F-53 Unit label: Y92S-L2 CX-Thermo Support Software: EST2-2C-MV4 DIN Tracks: PFP-100N/PFP-50N Spacer: PFP-S End Plate: PFP-M End Cover: Y92F-54 Connector cover: E53-COV26

Accuracy

Indication accuracy	Thermocouple: ($\pm 0.3\%$ of indicated value or $\pm 1\text{ }^\circ\text{C}$, whichever is greater) ± 1 digit max. Platinum resistance thermometer: ($\pm 0.2\%$ of indicated value or $\pm 0.8\text{ }^\circ\text{C}$, whichever is greater) ± 1 digit max. Analog input: $\pm 0.2\%$ FS ± 1 digit max. (The indication accuracy of K thermocouples in the -200 to $1300\text{ }^\circ\text{C}$ range, T and N thermocouples at a temperature of $-100\text{ }^\circ\text{C}$ max., and U and L thermocouples at any temperatures is $\pm 2\text{ }^\circ\text{C}$ ± 1 digit max. B thermocouple at a temperature of $400\text{ }^\circ\text{C}$ max. is not specified. B thermocouples in the 400 to $800\text{ }^\circ\text{C}$ range is $\pm 3\text{ }^\circ\text{C}$ max. R and S thermocouples at a temperature of $200\text{ }^\circ\text{C}$ max. is $\pm 3\text{ }^\circ\text{C}$ ± 1 digit max. C/W thermocouples is ($\pm 0.3\%$ PV or $\pm 3\text{ }^\circ\text{C}$, whichever is greater) ± 1 digit max. PL II thermocouples is ($\pm 0.3\%$ PV or $\pm 2\text{ }^\circ\text{C}$, whichever is greater) ± 1 digit max.)
Influence of temperature/voltage	Thermocouple: R, S, B, C/W, and PLII: ($\pm 1\%$ of indicated value or $\pm 10\text{ }^\circ\text{C}$, whichever is greater) ± 1 digit max. Other thermocouple: ($\pm 1\%$ of indicated value or $\pm 4\text{ }^\circ\text{C}$, whichever is greater) ± 1 digit max.. However K thermocouple at $-100\text{ }^\circ\text{C}$ max.: $\pm 10\text{ }^\circ\text{C}$ max. Platinum resistance thermometer: ($\pm 1\%$ of indication value or $\pm 2\text{ }^\circ\text{C}$, whichever is greater) ± 1 digit max. Analog input: $\pm 1\%$ FS ± 1 digit max. Ambient temperature: -10 to 23 to $55\text{ }^\circ\text{C}$, Voltage range: -15 to 10% of rated voltage
Influence of EMS.	Thermocouple: R, S, B, C/W, and PLII: ($\pm 1\%$ of indicated value or $\pm 10\text{ }^\circ\text{C}$, whichever is greater) ± 1 digit max. Other thermocouple: ($\pm 1\%$ of indicated value or $\pm 4\text{ }^\circ\text{C}$, whichever is greater) ± 1 digit max.. However K thermocouple at $-100\text{ }^\circ\text{C}$ max.: $\pm 10\text{ }^\circ\text{C}$ max. Platinum resistance thermometer: ($\pm 1\%$ of indication value or $\pm 2\text{ }^\circ\text{C}$, whichever is greater) ± 1 digit max. Analog input: $\pm 1\%$ FS ± 1 digit max.
Influence of signal source resistance	Thermocouple: $0.1\text{ }^\circ\text{C}/\Omega$ max. ($100\ \Omega$ max.) Platinum resistance thermometer: $0.1\text{ }^\circ\text{C}/\Omega$ max. ($10\ \Omega$ max.)

Dimensions

情報更新：2025/11/04

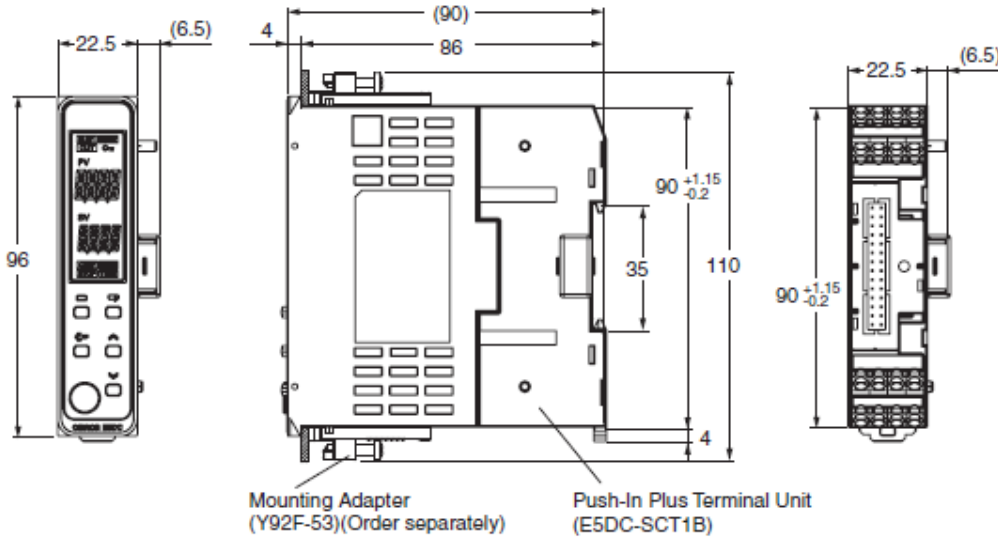

- Setup Tool ports are provided as standard feature. Use these ports to connect a computer to the Digital Temperature Controller. The E58-CIFQ2 USB-Serial Conversion Cable is required to connect to the port on the bottom panel. The E58-CIFQ2 USB-Serial Conversion Cable and E58-CIFQ2-E Communications Conversion Cable are required to connect to the port on the front panel. (You cannot leave either port connected constantly during operation.)

Mounted Separately

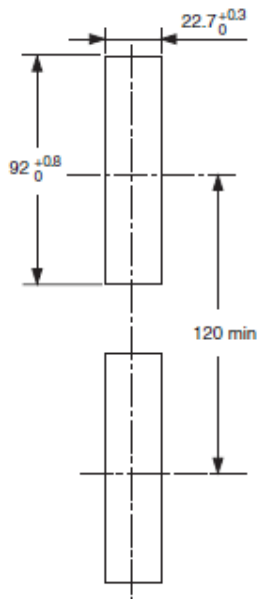

Two-Unit Mounting

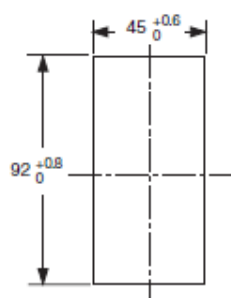

Group Mounted

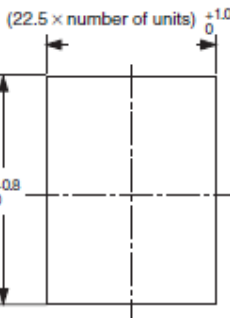

- Recommended panel thickness is 1 to 8 mm.
- Group mounting is not possible in the vertical direction. (Maintain the specified mounting space between Controllers.)
- When two or more Digital Temperature Controllers are mounted, make sure that the surrounding temperature does not exceed the allowable operating temperature specified in the specifications.

Connection diagram

情報更新：2025/11/04

E5DC-B (Models with Push-In Plus Terminal Blocks)

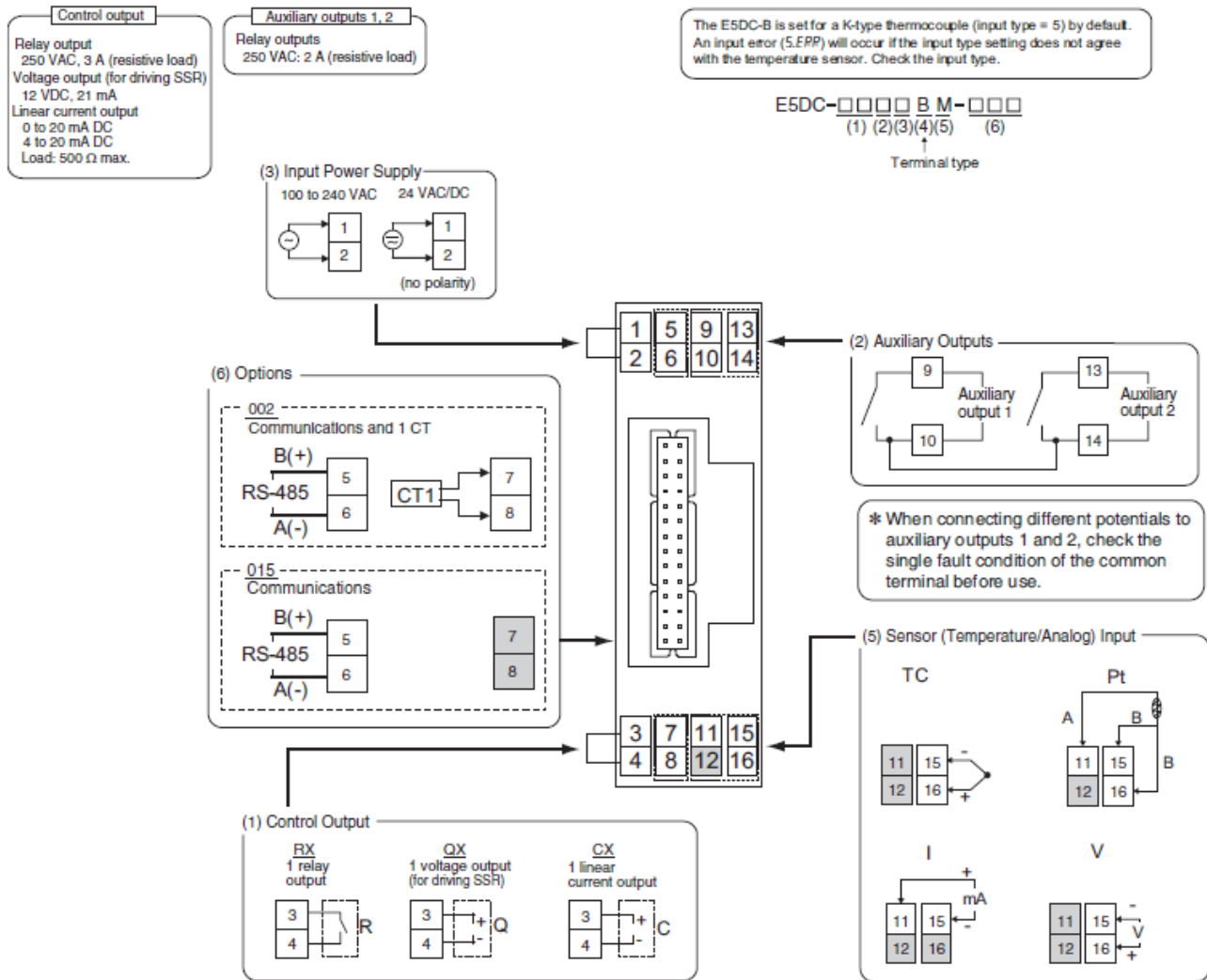

- Note:**
1. The application of the terminals depends on the model.
 2. Do not wire the terminals that are shown with a gray background.
 3. When complying with EMC standards, the cable that connects the sensor must be 30 m or less. If the cable length exceeds 30m, compliance with EMC standards will not be possible.
 4. Refer to Wiring Precautions for *E5DC-B (Controllers with Push-In Plus Terminal Blocks)* on page 133 for wire specifications and wiring methods.
 5. Due to UL Listing requirements, use the E54-CT1L or E54-CT3L Current Transformer with the factory wiring (internal wiring). Use a UL category XOBA or XOBA7 current transformer that is UL Listed for field wiring (external wiring) and not the factory wiring (internal wiring).
 6. The terminal layout is different than models with screw terminal blocks. Check the terminal arrangement before wiring.
 7. The event input specification main unit is not used with models with Push-In Plus terminal blocks.

Input ranges list

情報更新：2025/11/04

Thermocouple/Platinum Resistance Thermometer (Universal inputs)



Shaded settings are the default settings.

The applicable standards for the input types are as follows:

K, J, T, E, N, R, S, B: JIS C 1602-2015, IEC 60584-1

JPt100: JIS C 1604-1989, JIS C 1606-1989

L: Fe-CuNi, DIN 43710-1985

Pt100: JIS C 1604-1997, IEC 60751

U: Cu-CuNi, DIN 43710-1985

PL II: According to Platine II electromotive force charts from BASF (previously Engelhard)

C/W: W5Re/W26Re, JIS C 1602-2015, ASTM E988-1990

Analog input

Input type	Current		Voltage		
Input specification	4 to 20 mA	0 to 20 mA	1 to 5 V	0 to 5 V	0 to 10 V
Setting range	Usable in the following ranges by scaling: -1999 to 9999, -199.9 to 999.9, -19.99 to 99.99 or -1.999 to 9.999				
Set value	25	26	27	28	29













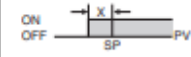

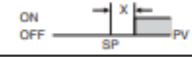
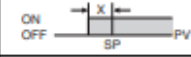

Alarm mode list

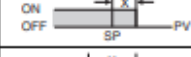
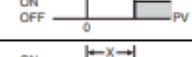
情報更新：2025/11/04

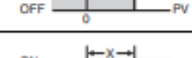
Each alarm can be independently set to one of the following 17 alarm types. The default is 2: Upper limit. (See note.)

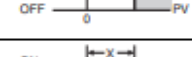
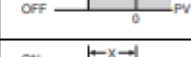
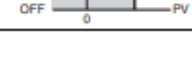
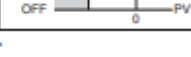
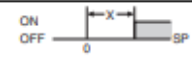
Auxiliary outputs are allocated to alarms. ON delays and OFF delays (0 to 999 s) can also be specified.

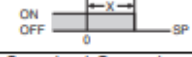
Note: In the default settings for models with HB or HS alarms, alarm 1 is set to a heater alarm (HA) and the Alarm Type 1 parameter is not displayed. To use alarm 1, set the output assignment to alarm 1.

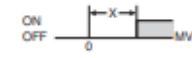
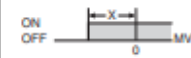
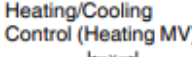
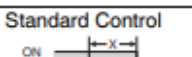
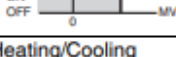
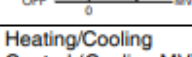
Set value	Alarm type	Alarm output operation		Description of function
		When alarm value X is positive	When alarm value X is negative	
0	Alarm function OFF	Output OFF		No alarm
1	Upper- and lower-limit *1	ON OFF 	*2	Set the upward deviation in the set point for the alarm upper limit (H) and the lower deviation in the set point for the alarm lower limit (L). The alarm is ON when the PV is outside this deviation range.
2 (default)	Upper-limit	ON OFF 	ON OFF 	Set the upward deviation in the set point by setting the alarm value (X). The alarm is ON when the PV is higher than the SP by the deviation or more.
3	Lower-limit	ON OFF 	ON OFF 	Set the downward deviation in the set point by setting the alarm value (X). The alarm is ON when the PV is lower than the SP by the deviation or more.
4	Upper- and lower-limit range *1	ON OFF 	*3	Set the upward deviation in the set point for the alarm upper limit (H) and the lower deviation in the set point for the alarm lower limit (L). The alarm is ON when the PV is inside this deviation range.
5	Upper- and lower-limit with standby sequence *1	ON OFF 	*4	A standby sequence is added to the upper- and lower-limit alarm (1). *6
6	Upper-limit with standby sequence	ON OFF 	ON OFF 	A standby sequence is added to the upper-limit alarm (2). *6
7	Lower-limit with standby sequence	ON OFF 	ON OFF 	A standby sequence is added to the lower-limit alarm (3). *6
8	Absolute-value upper-limit	ON OFF 	ON OFF 	The alarm will turn ON if the process value is larger than the alarm value (X) regardless of the set point.
9	Absolute-value lower-limit	ON OFF 	ON OFF 	The alarm will turn ON if the process value is smaller than the alarm value (X) regardless of the set point.
10	Absolute-value upper-limit with standby sequence	ON OFF 	ON OFF 	A standby sequence is added to the absolute-value upper-limit alarm (8). *6
11	Absolute-value lower-limit with standby sequence	ON OFF 	ON OFF 	A standby sequence is added to the absolute-value lower-limit alarm (9). *6
12	LBA (alarm 1 type only)	-		*7
13	PV change rate alarm	-		*8
14	SP absolute-value upper-limit alarm	ON OFF 	ON OFF 	This alarm type turns ON the alarm when the set point (SP) is higher than the alarm value (X).
15	SP absolute-value lower-limit alarm	ON OFF 	ON OFF 	This alarm type turns ON the alarm when the set point (SP) is lower than the alarm value (X).
16	MV absolute-value upper-limit alarm *9	Standard Control ON OFF 	Standard Control ON OFF 	This alarm type turns ON the alarm when the manipulated variable (MV) is higher than the alarm value (X).
		Heating/Cooling Control (Heating MV) ON OFF 	Heating/Cooling Control (Heating MV) Always ON	
17	MV absolute-value lower-limit alarm *9	Standard Control ON OFF 	Standard Control ON OFF 	This alarm type turns ON the alarm when the manipulated variable (MV) is lower than the alarm value (X).
		Heating/Cooling Control (Cooling MV) ON OFF 	Heating/Cooling Control (Cooling MV) Always ON	

RoHS/REACH対応状況

情報更新：2026/6/17

EU RoHS

対応状況 ※1	対応予定月 ※2	非含有証明書 ※3
 対応済み		ダウンロードはこちら

中国 RoHS

中国 RoHS表 ※1※2										
Pb	Hg	Cd	Cr(VI)	PBBs	PBDEs	DBP	DIBP	BBP	DEHP	環境保護 使用期限
X	0	0	0	0	0	0	0	0	0	10

- ・“対応済み”や非含有の記載がされた商品であっても、流通在庫等で未対応品が混在する可能性があります。
- ・非含有品が必要な際は、弊社営業部門もしくは販売店へお問い合わせください。

[この製品のRoHS/REACH対応状況ページへ>](#)

注意事項・凡例

”対応済み”で記載される商品であっても、流通在庫等で未対応品が混在する可能性があります。
非含有品が必要な際は、弊社営業部門もしくは販売店へお問い合わせください。

※1 対応状況

- ・  対応済み : EU RoHS指令（10物質）の非含有に対応した製品が提供可能な商品です。
- ・ 対応予定 : EU RoHS指令（10物質）の非含有に対応した製品に切り替える予定のある商品です。
- ・ 対応予定なし : EU RoHS指令（10物質）の非含有に非対応の商品で、対応品を出す予定はありません。
- ・ 調査・確認中 : EU RoHS指令（10物質）の非含有の対応状況を調査中または確認中の商品です。
- ・ 非該当品 : ライセンス料など無形物で、有害物質有無と関係のない商品です。

仕入先様の事情により、非含有部品としていたものが、含有品と判明した場合などやむを得ず変更することがあります。

* EU RoHS指令（10物質）：

鉛(Pb) 1000ppm以下、水銀(Hg) 1000ppm以下、カドミウム(Cd) 100ppm以下、六価クロム(Cr(VI)) 1000ppm以下、
ポリ臭化ビフェニル類(PBB) 1000ppm以下、ポリ臭化ジフェニルエーテル類(PBDE) 1000ppm以下、
フタル酸ビス(2-エチルヘキシル) (DEHP)(別名：DOP) 1000ppm以下、フタル酸ブチルベンジル (BBP) 1000ppm以下、
フタル酸ジブチル (DBP) 1000ppm以下、フタル酸ジイソブチル (DIBP) 1000ppm以下
但し、RoHS指令で産業用監視および制御機器に対する適用除外項目は除く。
フタル酸エステル類の4物質については閾値を超える意図的な使用がないことを確認しています。

※2 対応予定月

部品在庫の切り替え状況などにより、予定月が前後することがあります。

※3 非含有証明書ダウンロード

下記の非含有証明書をダウンロードすることができます。

- ・ EU RoHS指令（10物質）の非含有証明書
- ・ 49物質の非含有証明書（当社基準）

※ 本証明書は発行日時時点で非含有を証明するもので、過去に遡って非含有を証明するものではありません。

また、RoHS指令のフタル酸エステル類4物質の対応では、対応完了までの期間は出荷製品に未対応品が混在することから備考欄に
対応日を記載しておりました。

既に当社にて対応品への在庫切替を完了していることから、特段のことがない限り、2022年1月12日より割愛しております。

規格認証/適合状況

UL認証	CSA認証	CEマーキング	CCC認証	電波法
Yes	Yes	Yes	N/A	N/A

LR型式承認 （イギリス 船舶規格）	DNV型式承認 （ノルウェー 船舶規格）	BV型式承認 （フランス 船舶規格）	KR型式承認 （韓国 船舶規格）	NK型式承認 （日本 船舶規格）	ABS型式承認 （アメリカ 船舶規格）
No	No	No	No	No	No

[この製品の規格認証/適合状況ページへ>](#)
[その他の認証はこちらのページからご検索ください>](#)