

Device Selection Guide for Water Level Control Applications



Introduction

This Device Selection Guide for Water Level Control Applications is designed to help you select Level Controllers, Electrodes, and Sensing Bands according to the needs of specific water level control applications and goals. Please use this guide to help you select devices for your water level control applications.

Water Level Control

A toilet would be an example of water level control from everyday life. Using a float to control the water supply is commonly seen in toilet tanks. Float-controlled water supply uses no electricity. It is a low-cost mechanical control method that saves energy.

However, application of this method is limited because the float can be damaged, mechanical parts can corrode, unnecessary mechanical operation can occur, the length of the float arm is restricted, etc. The induction method used in the equipment presented in this guide, however, uses an electric Level Controller with no moving parts that can handle a wide range of general-purpose water level control and other liquid level control applications in the steel, food, chemical, pharmaceutical, semiconductor, and other industries, as well as in water purification and water treatment plants.

In comparison with static capacitance and ultrasonic methods, there is less chance of unnecessary operation for water surface changes such as those caused by waves the induction method allow stable water level detection at a low cost.

Induction

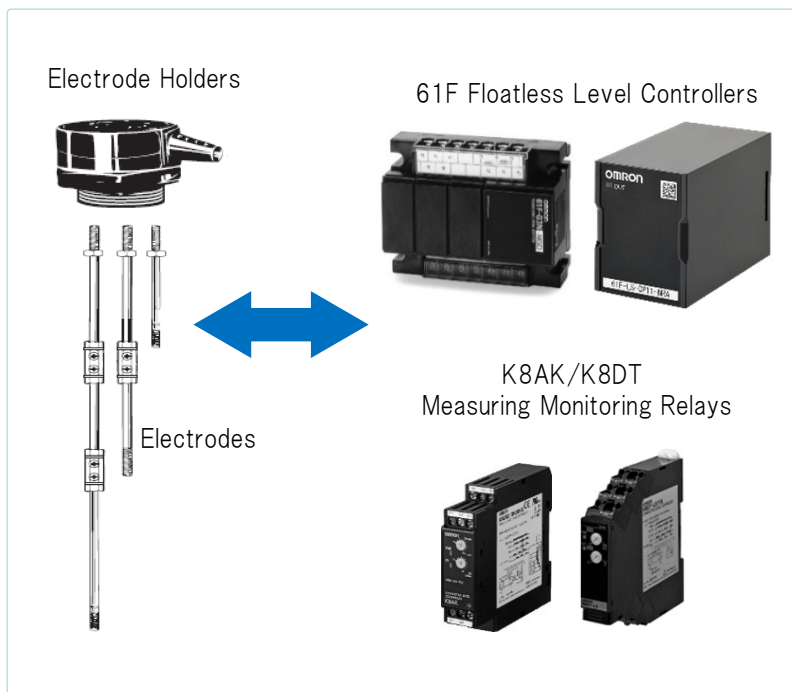

Float-control Water Supply

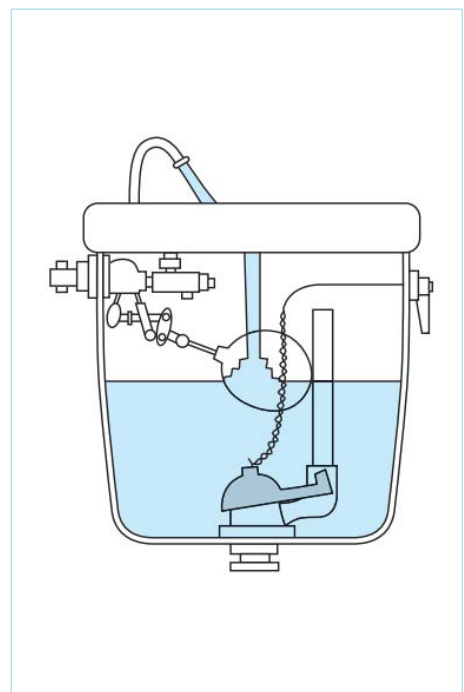

Table of Contents

Introduction	2
Water Level Control Application Examples	4
Basic Configuration of Water Level Control Devices	6
Recommended Selection of OMRON Water Level Controllers	8
Selecting a Suitable Water Level Controller	9
Flow to Select a Water Level Controller	10
Selecting Level Controllers Based on the Application(61F series)	
1. Automatic Water Supply Operation	12
2. Automatic Water Discharge Operation	13
3. Automatic Water Supply Operation with Dry Pump Operation Prevention	14
4. Automatic Water Supply Operation with Low Water Level Alarm	15
5. Automatic Water Supply Operation with High Water Level Alarm	16
6. Automatic Water Discharge Operation with High Water Level Alarm	17
7. Automatic Water Supply Operation with Full and Low Water Level Alarms	18
8. Automatic Water Discharge Operation with Full and Low Water Level Alarms	19
9. Automatic Water Supply Operation with Water Full/Shortage Alarms for an Elevated Tank and Water Level Indications for the Water Source (Prevention of Operating the Pump Dry)	20
10. Water Level Indicators and Alarms (with No Automatic Water Supply and Discharge Operation) ---	21
11. Selecting a Level Controller Based on the Application or Application Environment ---	22
12. Control and Detection Applications of Water Level Controllers	24
Selecting Level Controllers Based on the Application(K8AK/DT-LS1)	26
Selecting Electrode Holders	27
Selecting Electrodes	31
Additional Information(Maintenance/Peripheral Equipment)	35
Products for Leakage Detection Applications	37

Water Level Control Application Examples

The following are a few examples of water level control applications.

Controlling Water Supply to Elevated Water Tanks in Buildings

Clean water is automatically supplied to an elevated water tank with a pump.

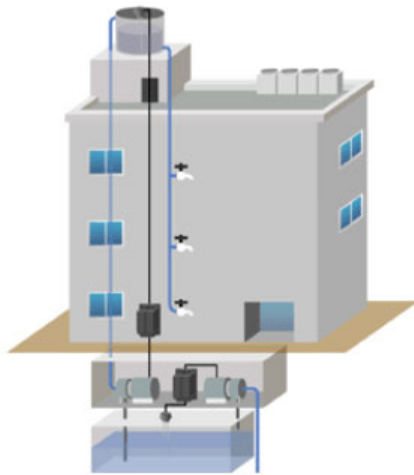

Controlling Waste Water Discharge to Waste Water Tanks under Buildings

Domestic waste water is collected in tanks and discharged with a pump to public sewage lines.

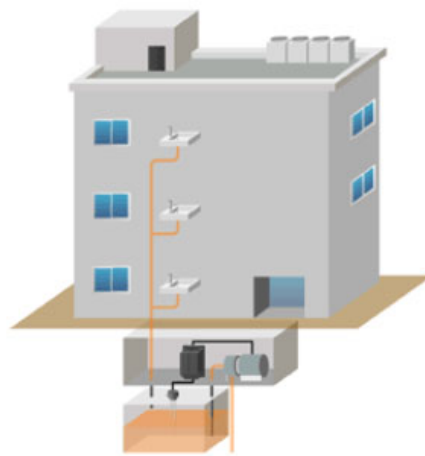

Material Level Control for Food Machines

Level control is performed in small tanks in liquid filling machines, drink vending machines, etc.



Level Control in Chemical or Pharmaceutical Tanks

A low-sensitivity 61F Floatless Level Controller is used to control the level of conductive chemicals and pharmaceuticals. However, it cannot be used when explosion-proofing is required.



Water Level Control Application Examples

Automatic Supply of Hot Water for Hot Springs and Detection of Hot Spring Water Shortage

Water is supplied from the hot springs to a holding tank. Also, pumps can be prevented from operating dry when the springs are not producing hot water and an alarm can be output to a suitable location.

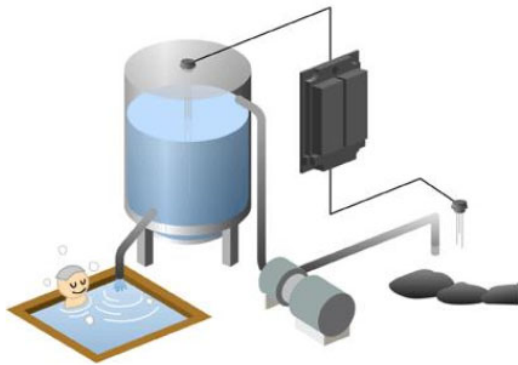

Detection of River Water Levels

Rising water levels and water shortages in rivers can be detected to provide notification and alarms to downstream areas. Breakwater tubes can also be used in this case.

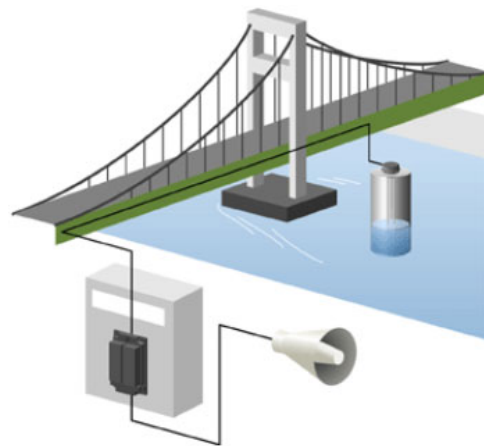

Monitoring Water Levels in Storage Ponds

Water levels are monitored in ponds for disaster relief and agriculture. Commands are output to open and close gates.

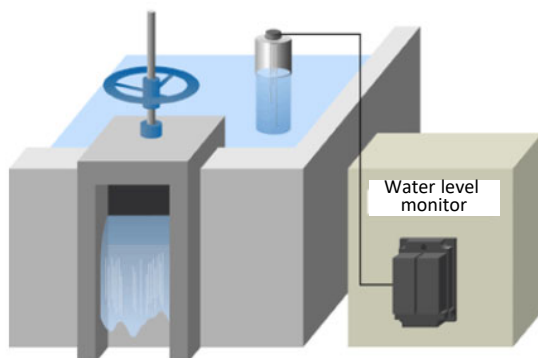

Wire Winding Detection

Not just liquids, but any conductive detection object can be detected.

One side of the 61F is connected to an Electrode and wire and the other side is connected to ground. The winding machine must also be grounded, so conductivity is created through ground to enable detecting the wire.

Also, by using a bar, the grounding range with the detection object can be expanded to enable allowing for the width that the wire moves when it is wound evenly.

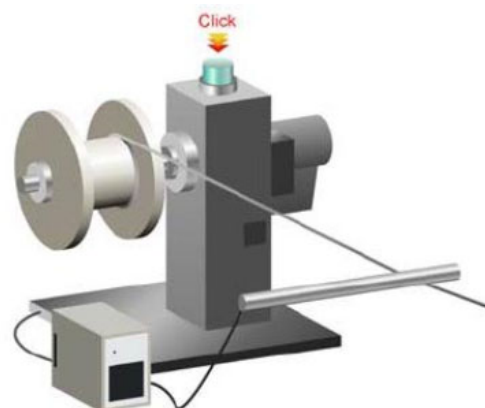

Basic Configuration of Water Level Control Devices

Water level control devices are basically composed of three components: a Level Controller, an Electrode Holder, and Electrodes. When you select products, select each of these components for your application.

Level Controllers

Select the Level Controller according to the control method, mounting method, object to detect, length of wiring, etc.

61F-series Level Controllers



K8AK-LS



K8DT-LS



Electrode Holders

Select the Electrode Holder according to the environment in the tank and the installation environment of the tank.

Electrodes

Select the Electrodes according to the environment in the tank and the control range.

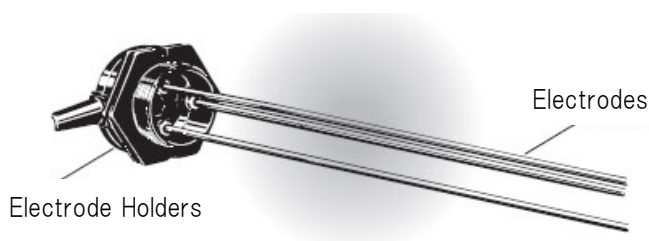

■ Configuration Example for Water Level Control





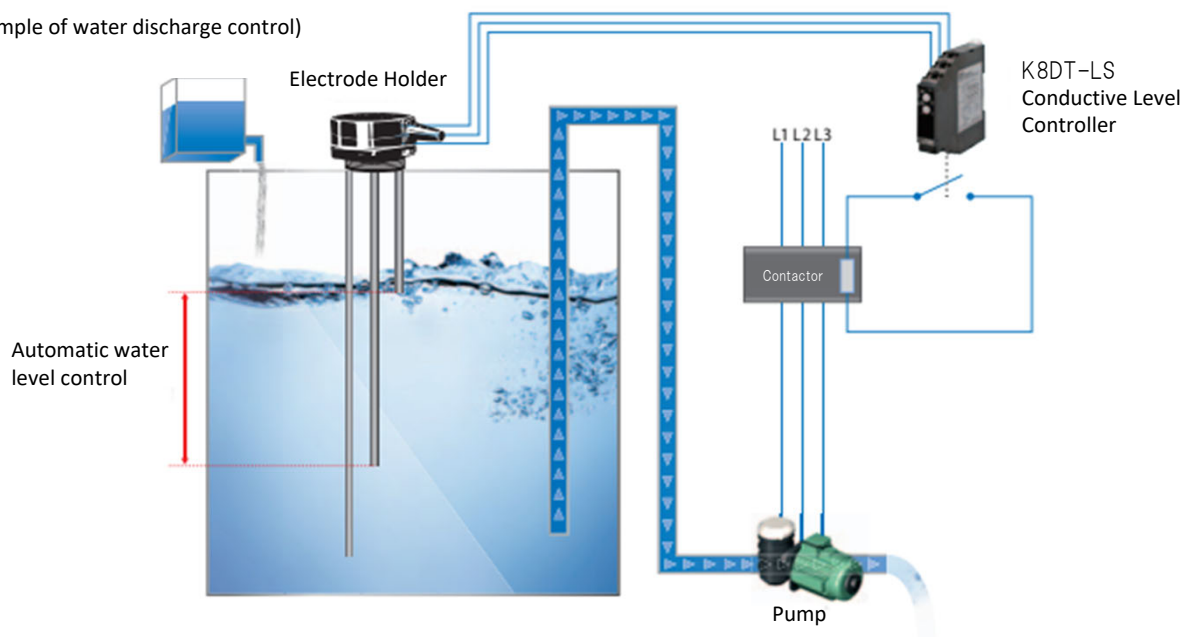

Tank Water Level Control

(Example of water discharge control)





Basic Configuration of Water Level Control Devices



■ Products Used for Water Level Control: Level Controllers, Electrode Holders, and Electrodes

	Level Controllers					
	61F				K8 Series	
Type	Compact, Plug-in	Plug-in	Compact	Basic Controllers	Controllers with Screw Terminals	Controllers with Push-In Plus Terminals
Appearance						
Model numbers	61F-LS	61F-G1P -G2P -IP	61F-GN -G1N -G2N -G3N -G4N -IN	61F-G -G1 -G2 -G3 -G4 -I	K8AK-LS	K8DT-LS
Features	<ul style="list-style-type: none"> · A Connecting Socket is required. · Models with 11-pins have independent DPDT contacts. 	<ul style="list-style-type: none"> · A Connecting Socket is required. · Can be mounted to DIN Track. · 220 VAC, 5A 	<ul style="list-style-type: none"> · Can be mounted to DIN Track. · Smaller than basic models. 	<ul style="list-style-type: none"> · Prewired when delivered (reduces wiring work). 	<ul style="list-style-type: none"> · Relay outputs. · 22.5 mm width. · Built-in ON-delay timer. · Screw terminals. 	<ul style="list-style-type: none"> · Transistor outputs. · Relay outputs. · 17.5 mm width. · Built-in ON-delay timer. · Push-In Terminals



	Electrode Holders		
Appearance			
Model numbers	PS-3S PS-4S PS-5S	BF-1 BF-3 BF-5	BS-1 BS-1T



	Electrodes		
Type	Standard Electrodes	Underwater Electrodes	Electrode Bands
Appearance			
Model numbers	F03-01 F03-60	PH-1 PH-2	F03-05 3P F03-05 4P F03-05 5P
Features		A Holder is not required.	

Recommended Selection of OMRON Water Level Controllers

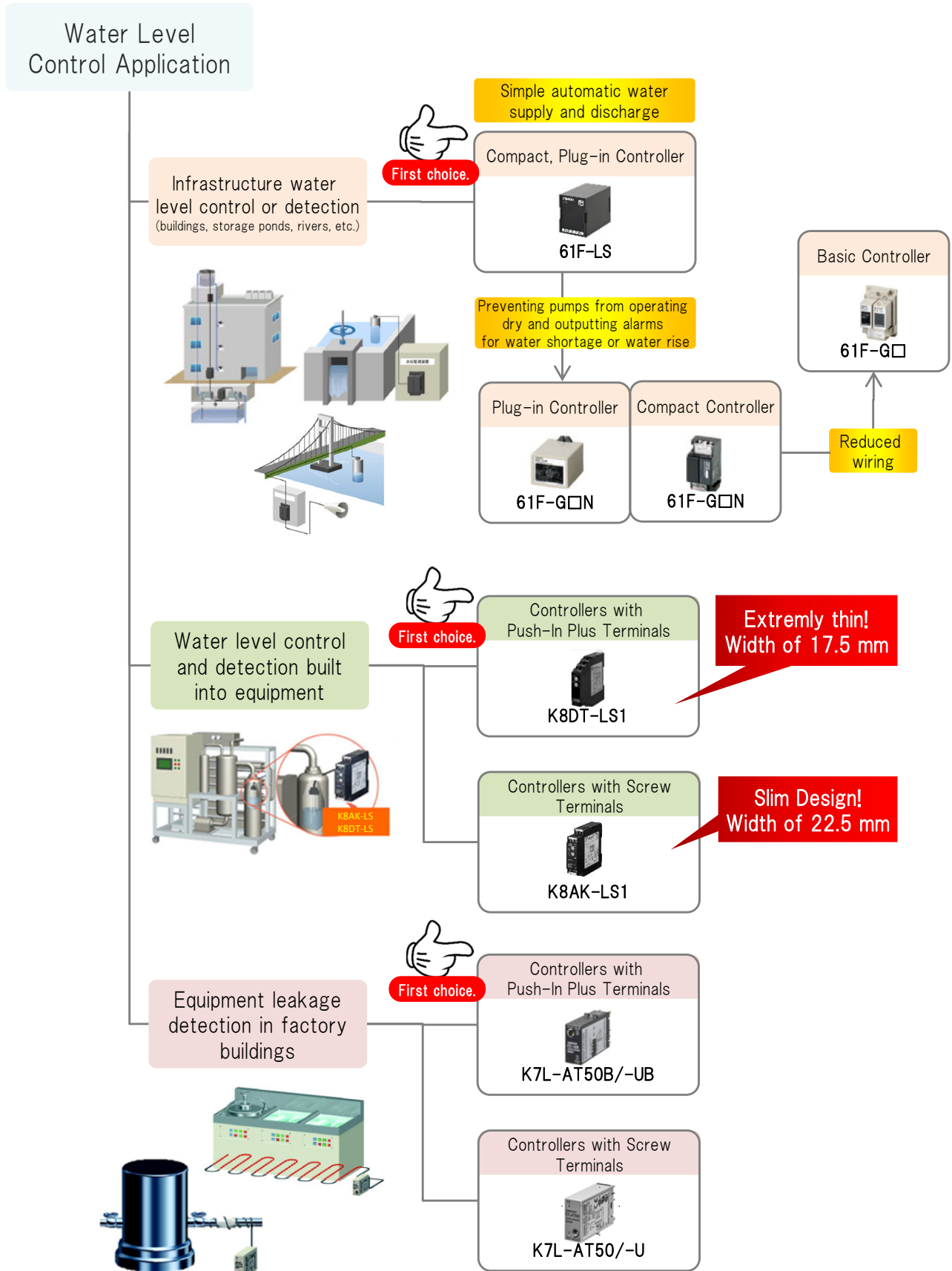

Selecting a Suitable Water Level Controller

<61F Series>

Infrastructure water level control or detection (buildings, storage ponds, rivers, etc.)

1 What is the goal of controlling the water level?

Function Selection by Application

- Automatically supplying water to elevated tanks on buildings
- Outputting alarms for water shortage or water rise in elevated tanks
- Automatically discharging waste water from tanks to sewage lines
- Detecting water leakage in facilities, from pipes, and on floors.

2 Where is the application?

Selecting Controllers Based on the Location

- Small control panels where space must be saved
- Built into equipment. Space is limited
- Easy maintenance. Fast wiring / Plug-in installation
- Location subject to vibration where secured wiring is required

3 What is the tank operating environment and contents?

Selecting models based on application environment and controlled item

- The tank and control panel for the Controller are separated by a long distance.
- Control is required for oil or pure water.
- Control is required for sewage, chemicals, or pharmaceuticals.
- The environment is subject to lightning or noise.

4 What type of tank is used?

Selecting Holders and Electrodes based on the tank where the water level is controlled.

- Deep tanks
- Small tanks inside equipment
- Tanks for food items
- High-temperature, high-pressure tanks

Flow to Select a Water Level Controller

The flow to select a Level Controller is given below using the compact 61F-GN Level Controllers as an example.

The 61F-GN Level Controllers can be used for supply, discharge, and most other types of water level control. The flow is for a combination of the GN-series Level Controller with an Electrode Holder and Electrodes.

1. Select the Level Controller according to the application goal.

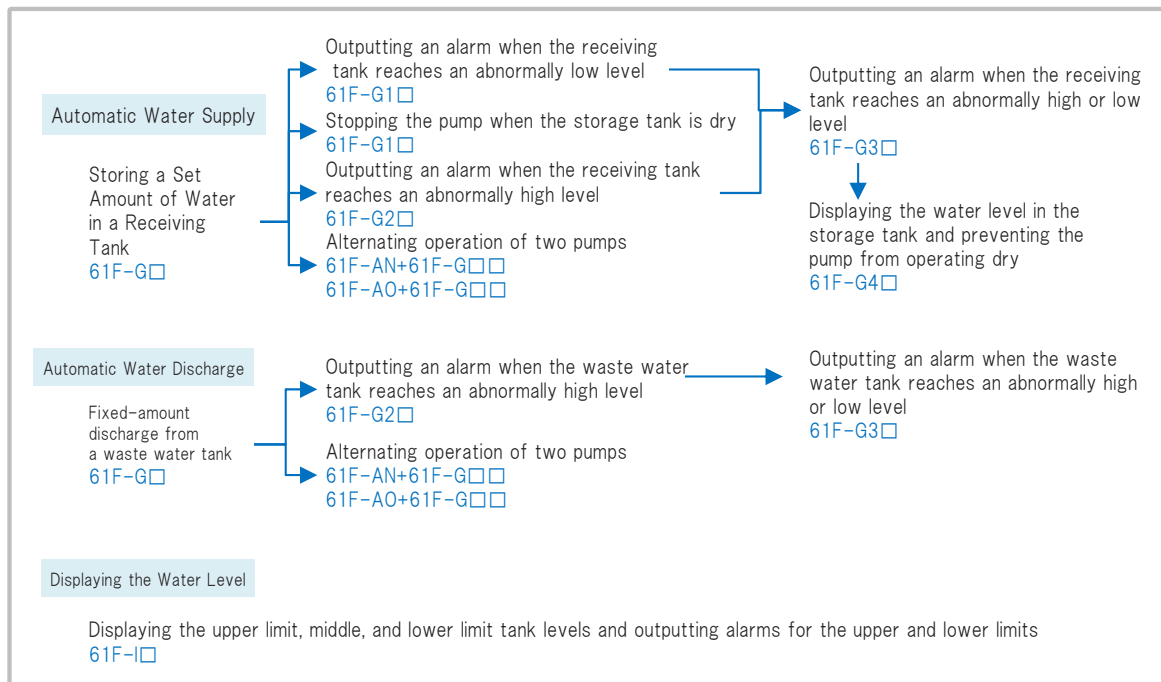

2. Allow for the application environment and conditions.

General Environment and Conditions	Ambient temperature of -10 to 55°C and 1 km or shorter distance between 61F Level Controller and water tank The models given above are suitable.	
Long-distance Applications	61F Level Controller and water tank separated by 2 km or less (61F-□□L 2KM) 61F Level Controller and water tank separated by 4 km or less (61F-□□L 4KM)	
High-sensitivity Application	For control of liquids with high specific resistance, such as distilled water (61F-□□H)	For control of liquids that resist the flow of electricity, such as for the detection of ice, highly pure steam, or humidity (61F-UHS, 61F-HSL)
Low-sensitivity Application	For control of liquids with low specific resistance such as salt water, sewage water, acid chemicals, alkali chemicals (61F-□□D)	
Locations with High Ambient Temperatures	Applications with ambient temperatures between -10 and 70°C (61F-□T) Heat resistant under Japanese fire laws. (61F-IP-22)	
Other Conditions	Detection is not possible for oils, powders, and any material that do not conduct.	

Flow to Select a Water Level Controller

3. Select the model of the Level Controller based on the installation conditions.

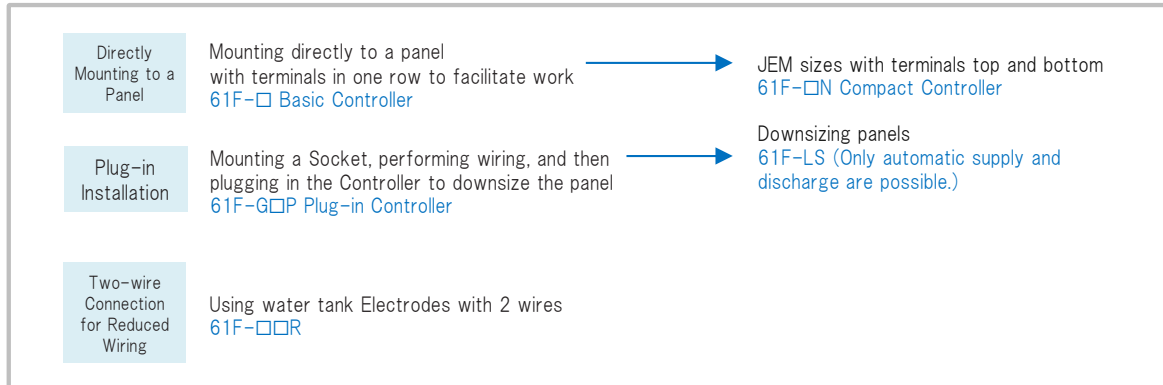

4. Select the Electrode Holder and Electrodes for the water tank.

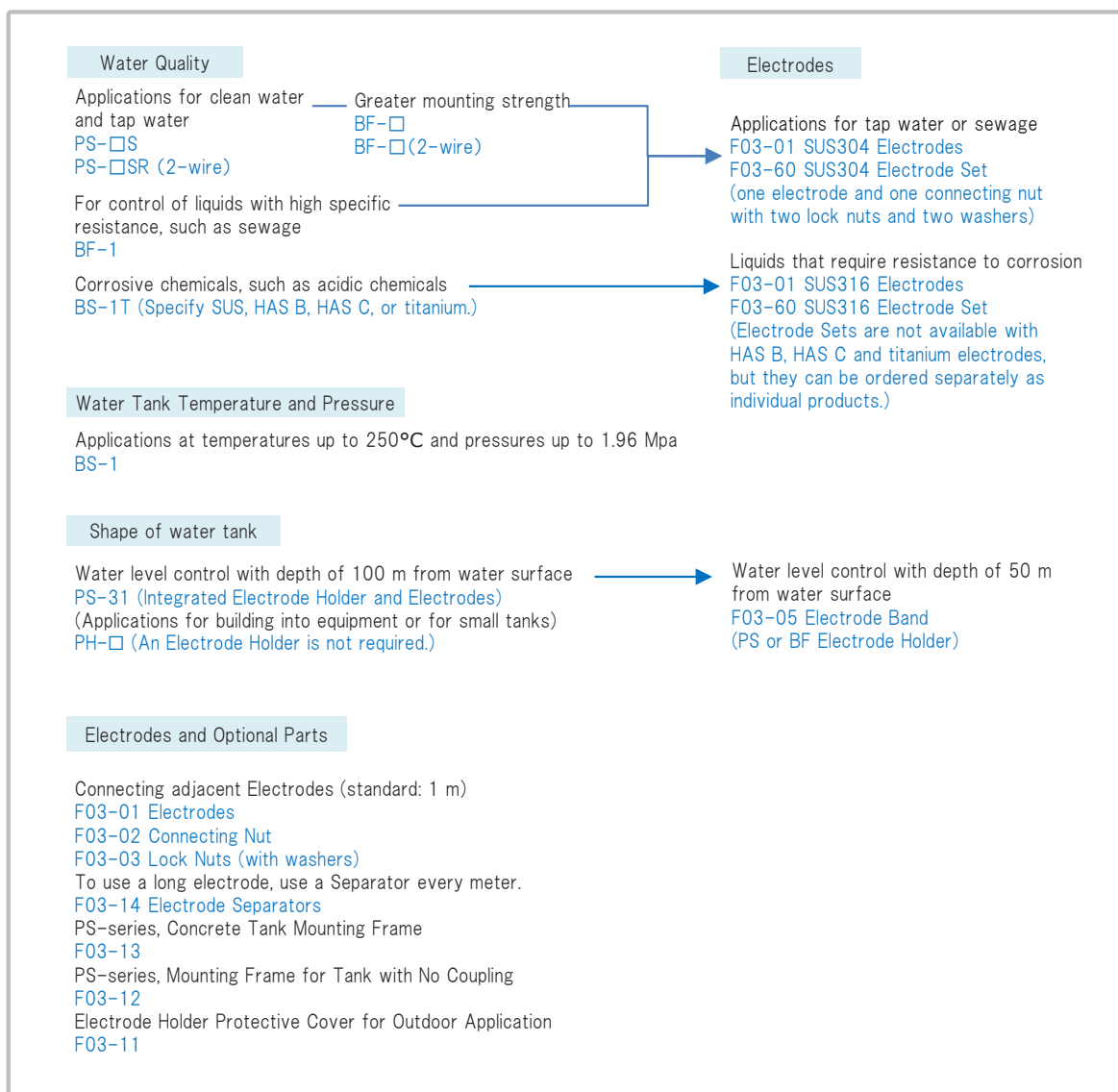

Selecting Level Controllers Based on the Application

1. Automatic Water Supply Operation

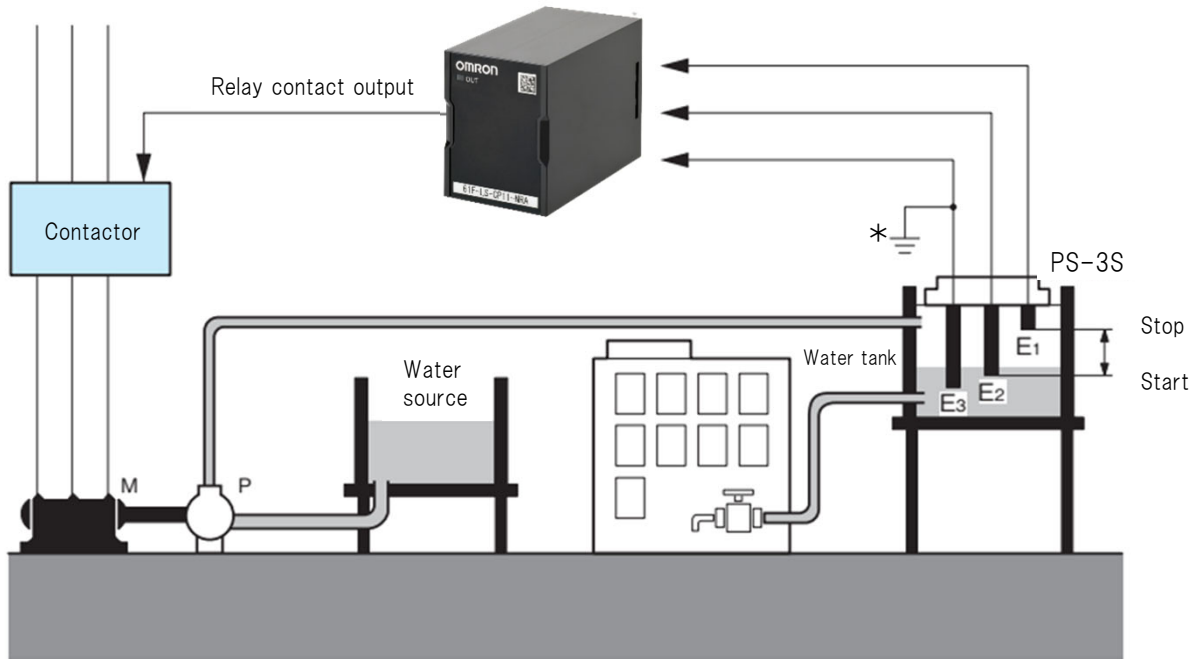

*Make sure that the common pole (the longest Electrode) is grounded securely.



First choice.

Model	Level Controller model number
Compact, Plug-in Controller with 8 Pins	61F-LS-CP08 series
Compact, Plug-in Controller with 11 Pins	61F-LS-CP11 series
Compact Controller	61F-GN (100/200 VAC)
Basic Controller	61F-G (100/200 VAC)

Principles of Operation

The pump stops (U indicator ON) when the water level reaches E₁ and starts (U indicator OFF) when the water level drops below E₂.

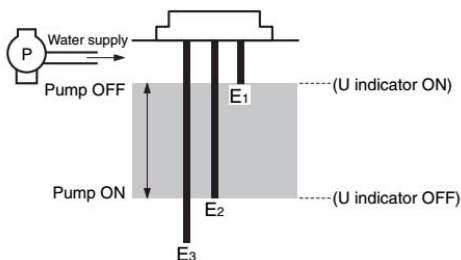

【Timing Chart】

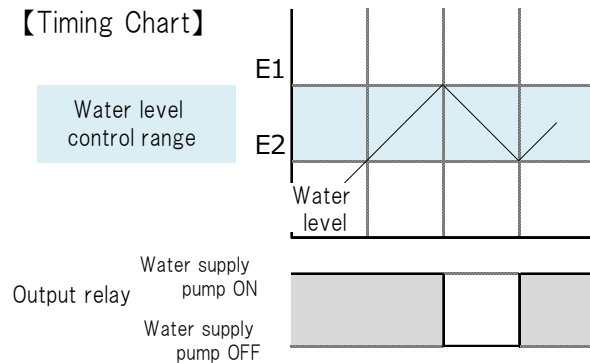

Selecting Level Controllers Based on the Application

2. Automatic Water Discharge Operation

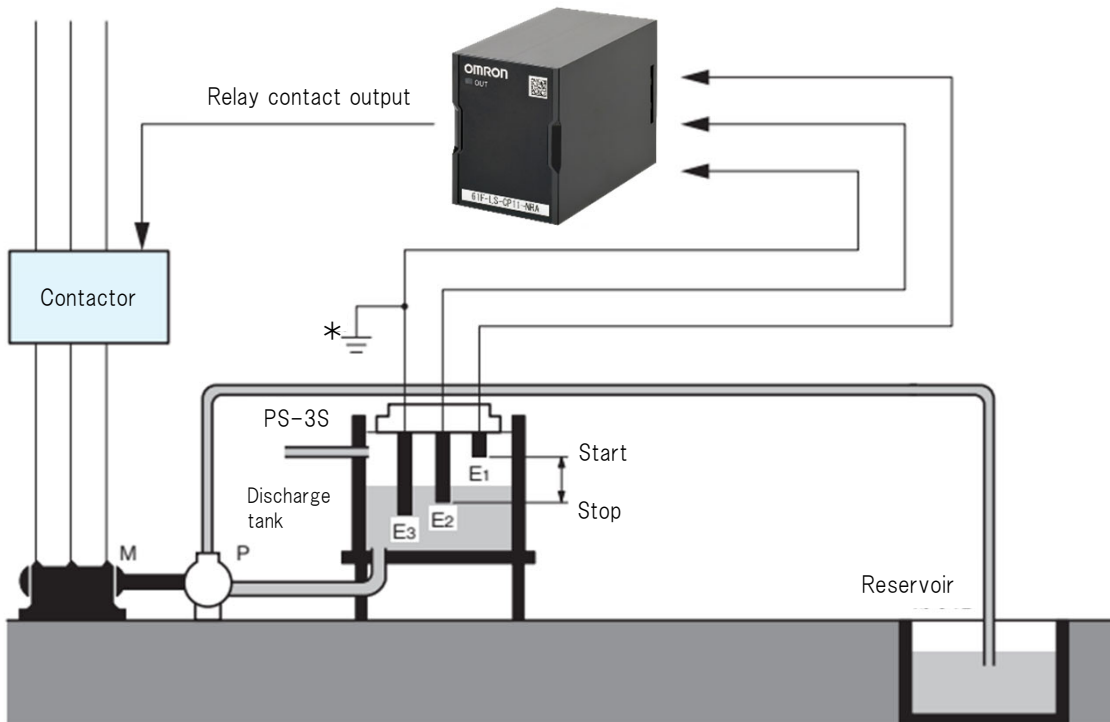

*Make sure that the common pole (the longest Electrode) is grounded securely.



First choice

Model	Level Controller model number
Compact, Plug-in Controller with 8 Pins	61F-LS-CP08 series
Compact, Plug-in Controller with 11 Pins	61F-LS-CP11 series
Compact Controller	61F-GN (100/200 VAC)
Basic Controller	61F-G (100/200 VAC)

Principles of Operation

The pump starts (U indicator ON) when the water level reaches E₁ and stops (U indicator OFF) when the water level drops below E₂.

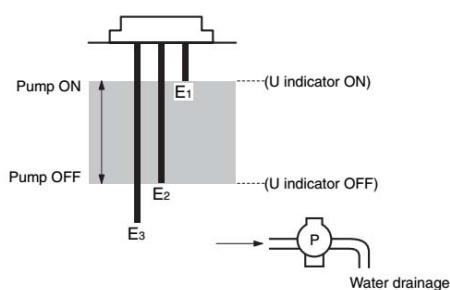

Timing Chart

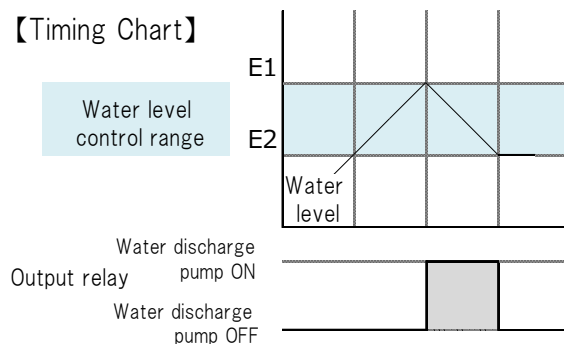

Selecting Level Controllers Based on the Application

3. Automatic Water Supply Operation with Dry Pump Operation Prevention

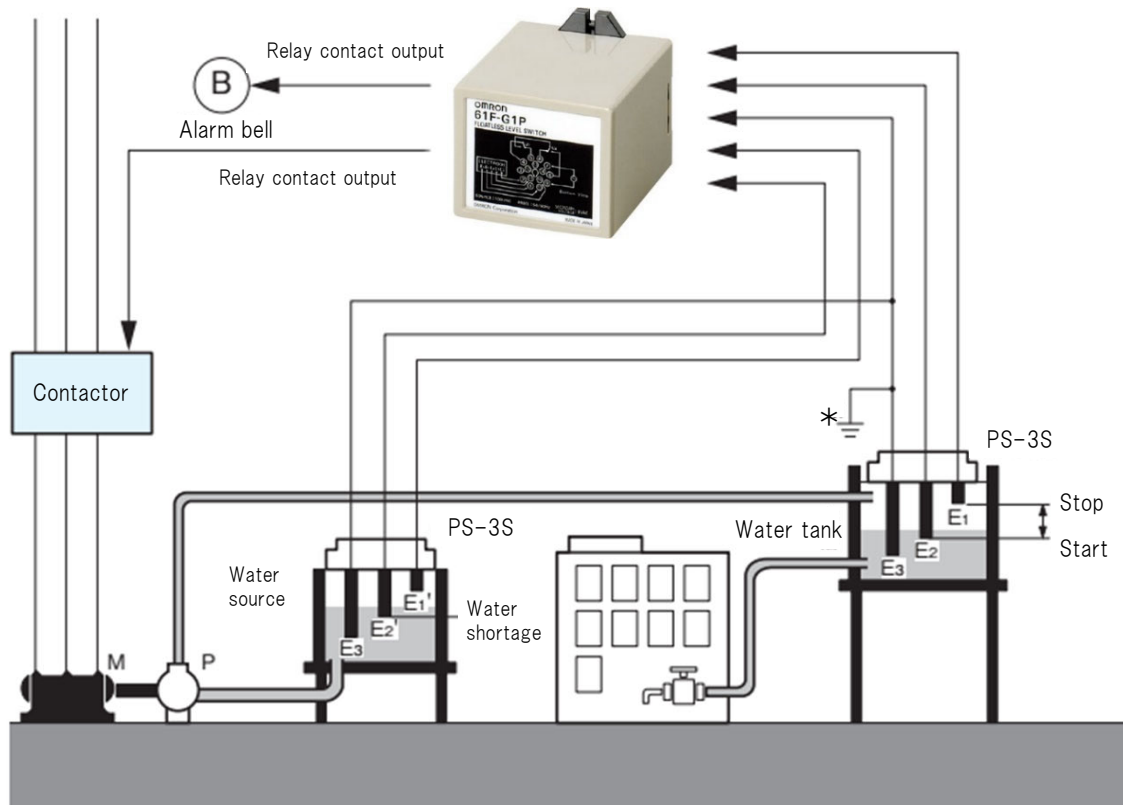

*Make sure that the common pole (the longest Electrode) is grounded securely.



First choice.

Model	Level Controller model number
Plug-in Level Controller with 14 Pins	61F-G1P (100 VAC) 61F-G1P (200 VAC)
Compact Controller	61F-G1N (100/200 VAC)
Basic Controller	61F-G1 (100/200 VAC)

Principles of Operation

- The pump starts (U_2 indicator OFF) when the water level drops below E_2 and stops (U_2 indicator ON) when water level reaches E_1 .
- The pump is forced to stop when the water supply source level drops below E_2' (U_1 indicator OFF) to prevent the pump from idling and gives an alarm.

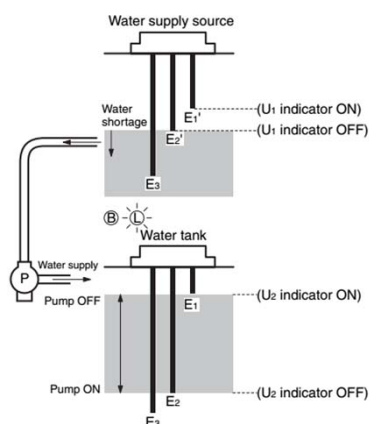

【Timing Chart】

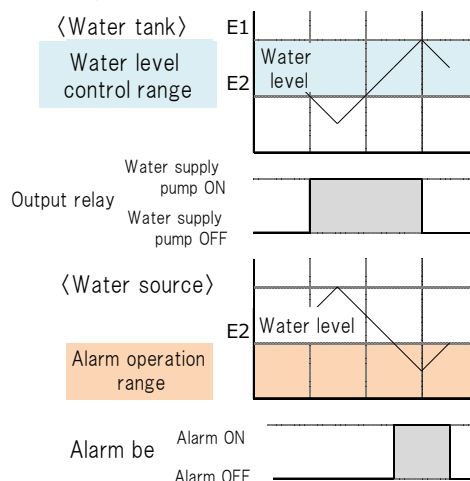

Selecting Level Controllers Based on the Application

<61F Series>

Infrastructure water level control or detection (buildings, storage ponds, rivers, etc.)

4. Automatic Water Supply Operation with Low Water Level Alarm

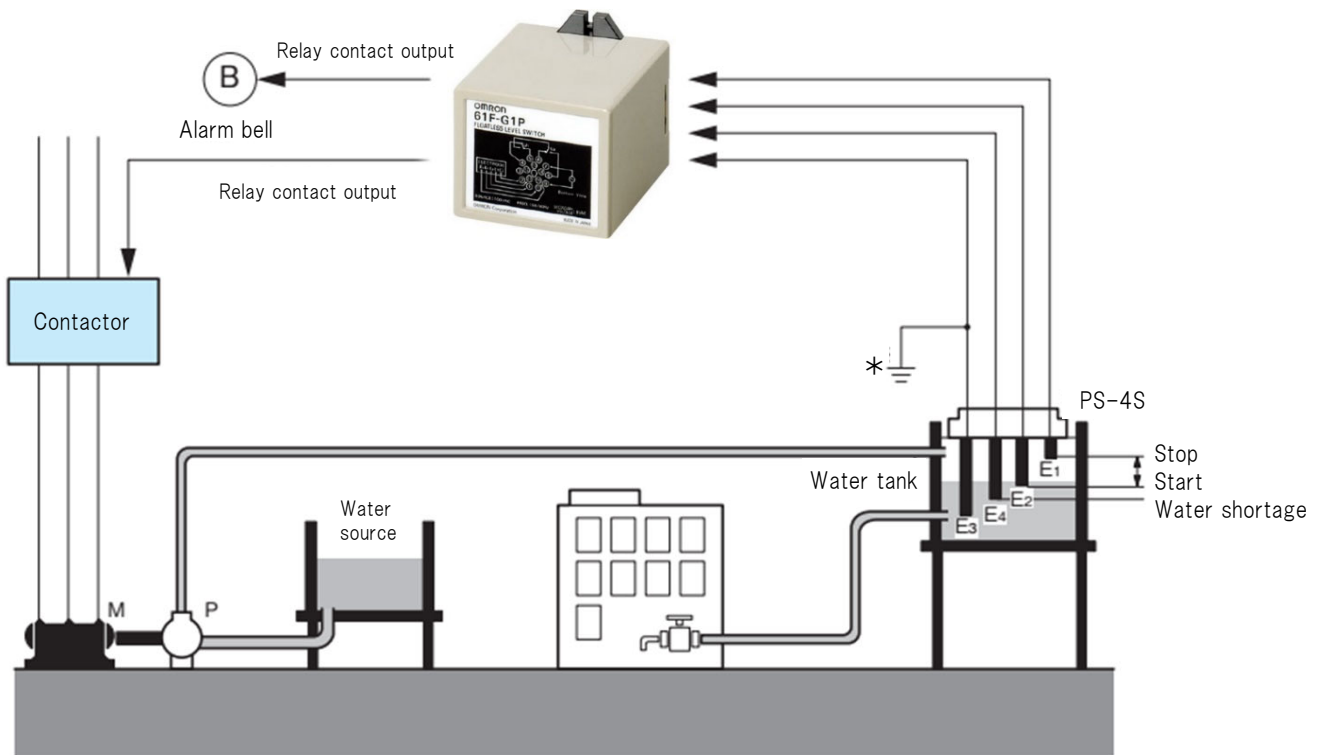

*Make sure that the common pole (the longest Electrode) is grounded securely.



First choice.

Model	Level Controller model number
Plug-in Level Controller with 14 Pins	61F-G1P (100 VAC) 61F-G1P (200 VAC)
Compact Controller	61F-G1N (100/200 VAC)
Basic Controller	61F-G1 (100/200 VAC)

Principles of Operation

- The pump stops (U_2 indicator ON) when the water level reaches E_2 and starts (U_2 indicator OFF) when water level drops below E_2 .
- If the water level drops below E_4 for any reason, an alarm is given (U_1 indicator OFF).

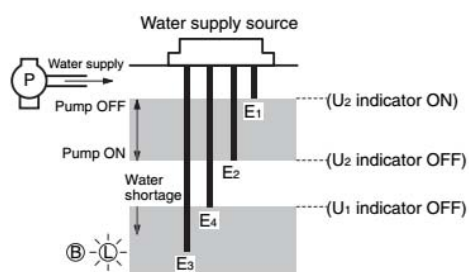

Timing Chart

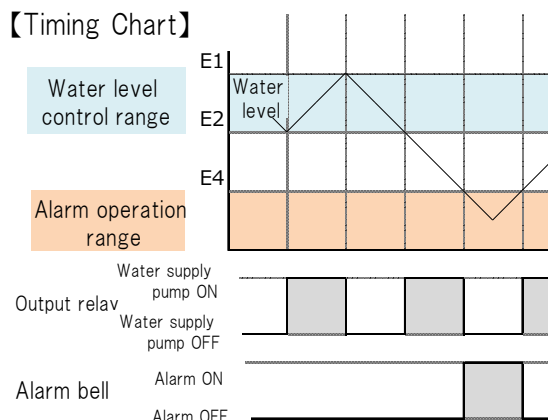

Selecting Level Controllers Based on the Application

5. Automatic Water Supply Operation with High Water Level Alarm

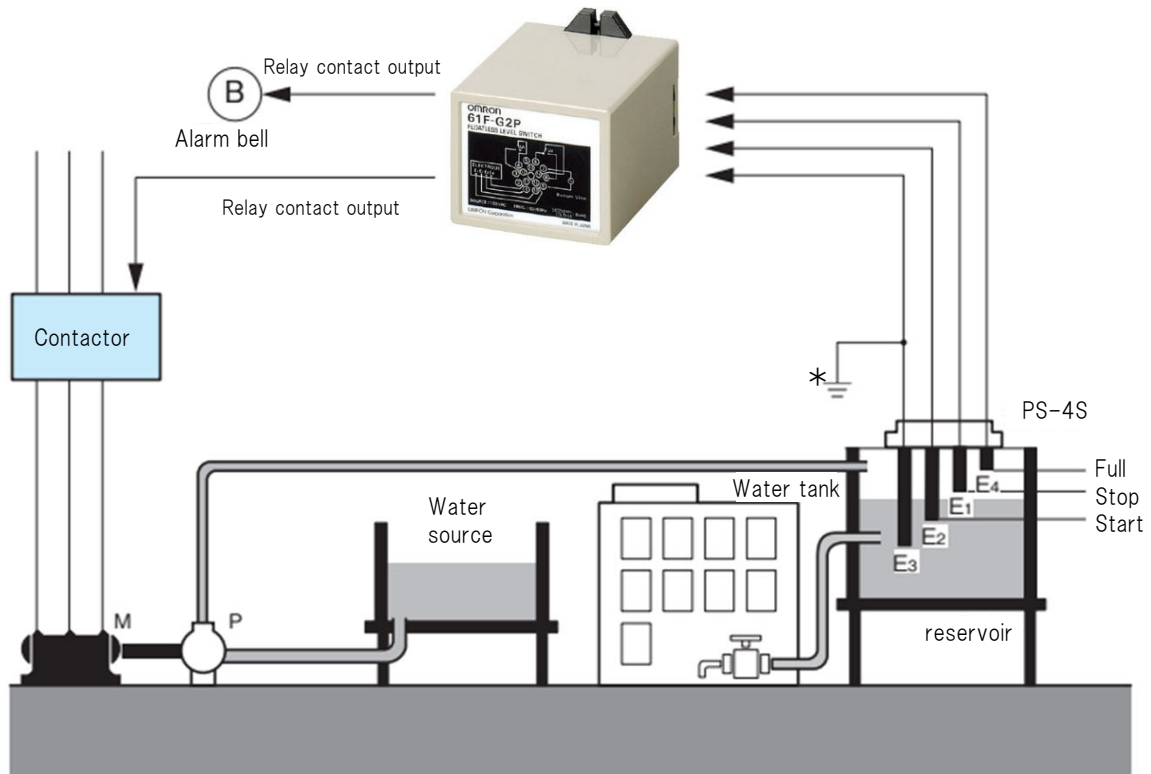

*Make sure that the common pole (the longest Electrode) is grounded securely.



First choice.

Model	Level Controller model number
Plug-in Level Controller with 14 Pins	61F-G2P(100 VAC) 61F-G2P(200 VAC)
Compact Controller	61F-G2N (100/200 VAC)
Basic Controller	61F-G2 (100/200 VAC)

Principles of Operation

- The pump starts (U_2 indicator OFF) when the water level reaches E_2 and stops (U_2 indicator ON) when the water level rises above E_2 .
- If the water level reaches E_4 for any reason, an alarm is given (U_1 indicator ON).

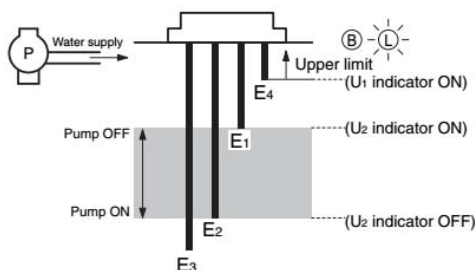

Timing Chart

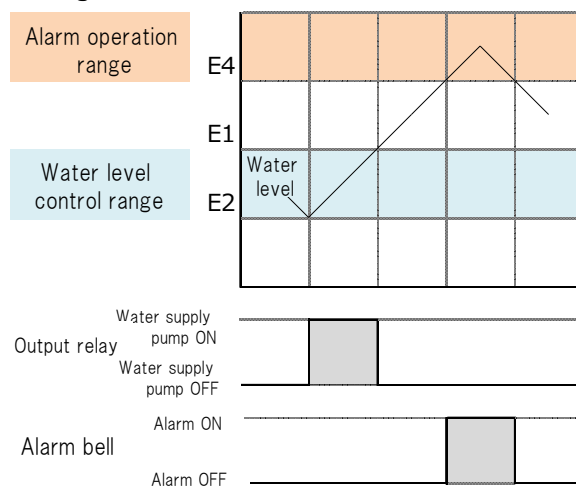

Selecting Level Controllers Based on the Application

6. Automatic Water Discharge Operation with High Water Level Alarm

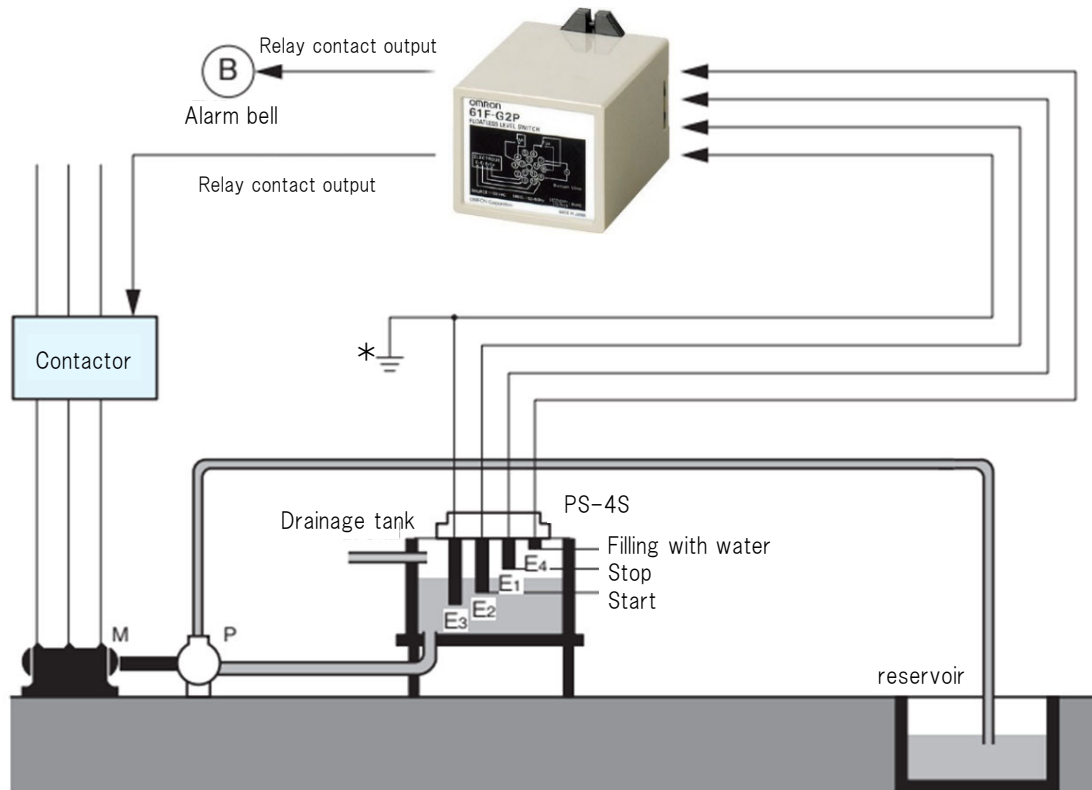

*Make sure that the common pole (the longest Electrode) is grounded securely.



First choice.

Model	Level Controller model number
Plug-in Level Controller with 14 Pins	61F-G2P (100 VAC) 61F-G2P (200 VAC)
Compact Controller	61F-G2N (100/200 VAC)
Basic Controller	61F-G2 (100/200 VAC)

Principles of Operation

- The pump starts (U₂ indicator ON) when the water level reaches E₁ and stops (U₂ indicator OFF) when the water level drops below E₂.
- If the water level reaches E₄ for any reason, an alarm is given (U₁ indicator ON).

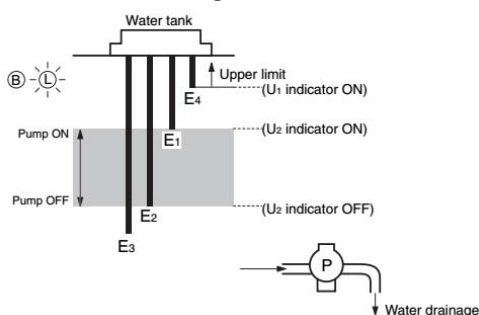

Timing Chart

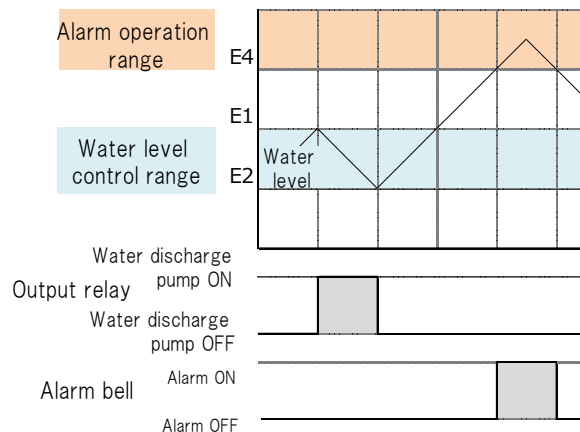

Selecting Level Controllers Based on the Application

7. Automatic Water Supply Operation with Full and Low Water Level Alarms

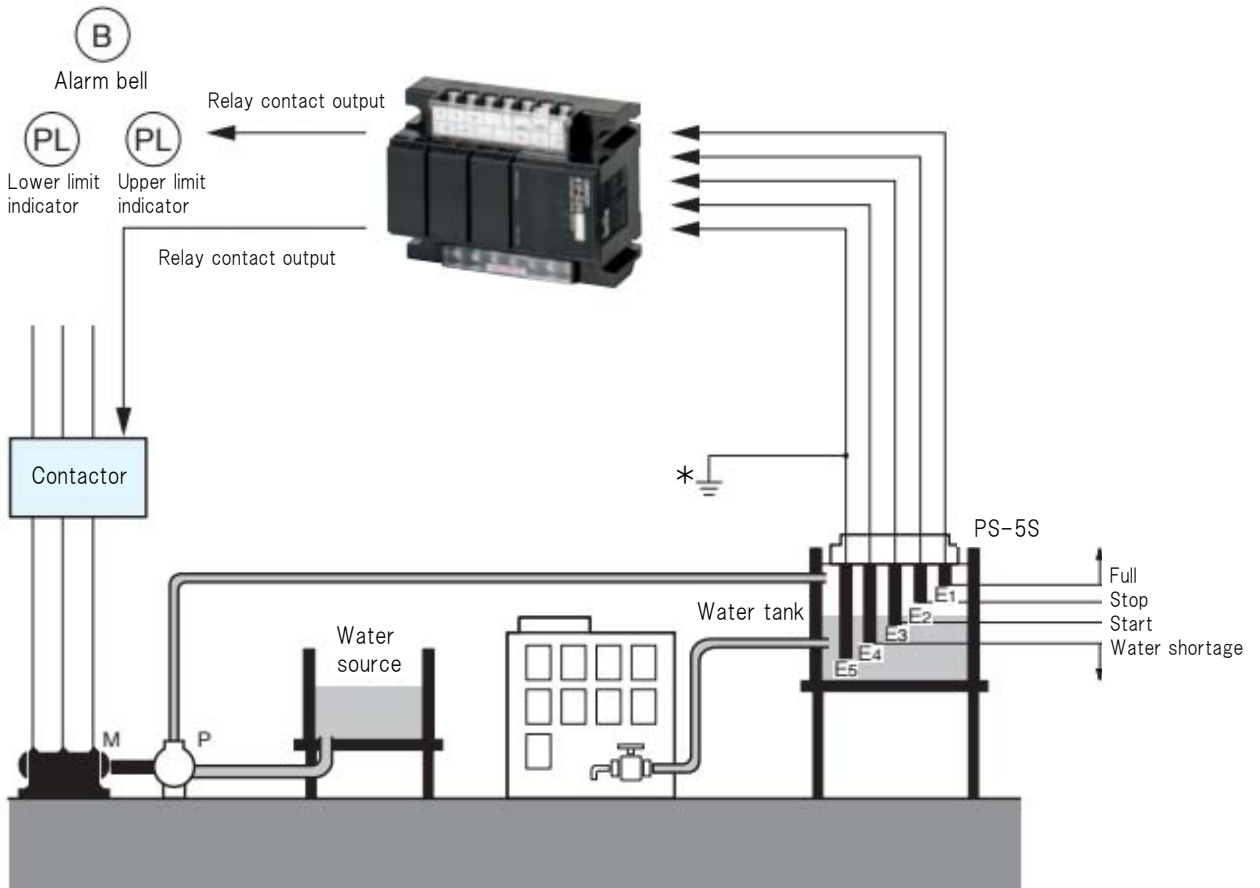

*Make sure that the common pole (the longest Electrode) is grounded securely.



First choice.

Model	Level Controller model number
Compact Controller	61F-G3N (100/200 VAC)
Basic Controller	61F-G3 (100/200 VAC)

Principles of Operation

- The pump starts (U₂ indicator ON) when the water level reaches E₂ and stops (U₂ indicator OFF) when the water level drops below E₃.
- If the water level rises to E₁ for any reason, the upper-limit indicator turns ON and an alarm is given (U₁ indicator ON). If the water level drops below E₄ for any reason, the lower-limit indicator turns ON and an alarm is given (U₃ indicator OFF).

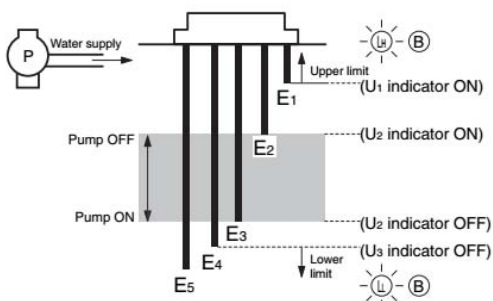

【Timing Chart】

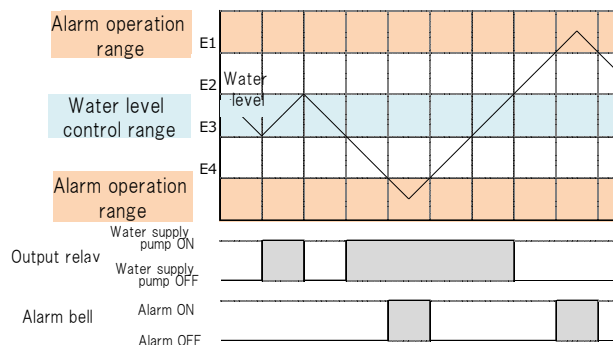

Selecting Level Controllers Based on the Application

8. Automatic Water Discharge Operation with Full and Low Water Level Alarms

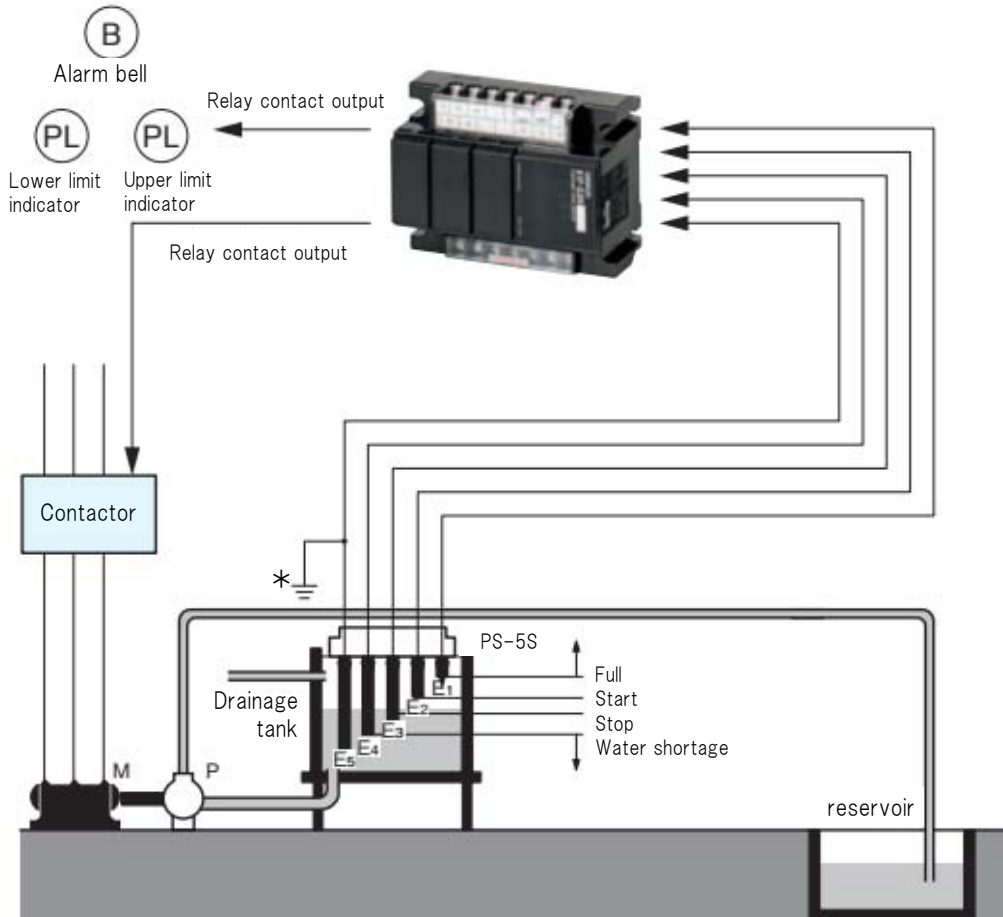

*Make sure that the common pole (the longest Electrode) is grounded securely.



First choice.

Model	Level Controller model number
Compact Controller	61F-G3N (100/200 VAC)
Basic Controller	61F-G3 (100/200 VAC)

Principles of Operation

- The pump starts (U_2 indicator ON) when the water level reaches E_2 and stops (U_2 indicator OFF) when the water level reaches E_3 .
- If the water level rises to E_1 for any reason, the upper-limit indicator turns ON and an alarm is given (U_1 indicator ON). If the water level drops below E_4 for any reason, the lower-limit indicator turns ON and an alarm is given (U_3 indicator OFF).

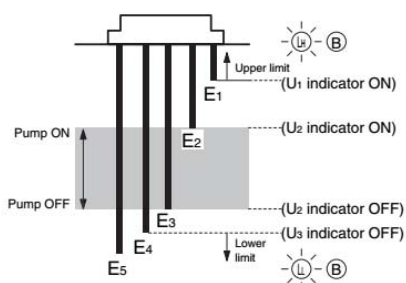

【Timing Chart】

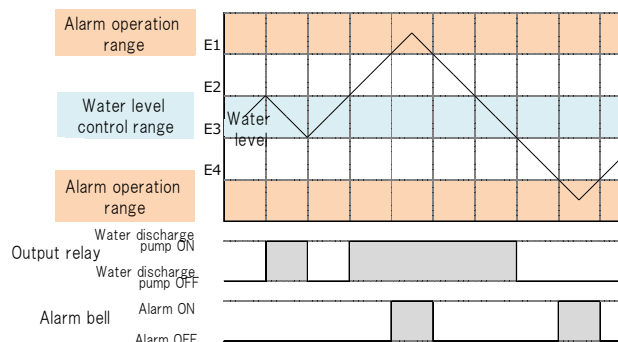

Selecting Level Controllers Based on the Application

9. Automatic Water Supply Operation with Water Full/Shortage Alarms for an Elevated Tank and Water Level Indications for the Water Source (Prevention of Operating the Pump Dry)

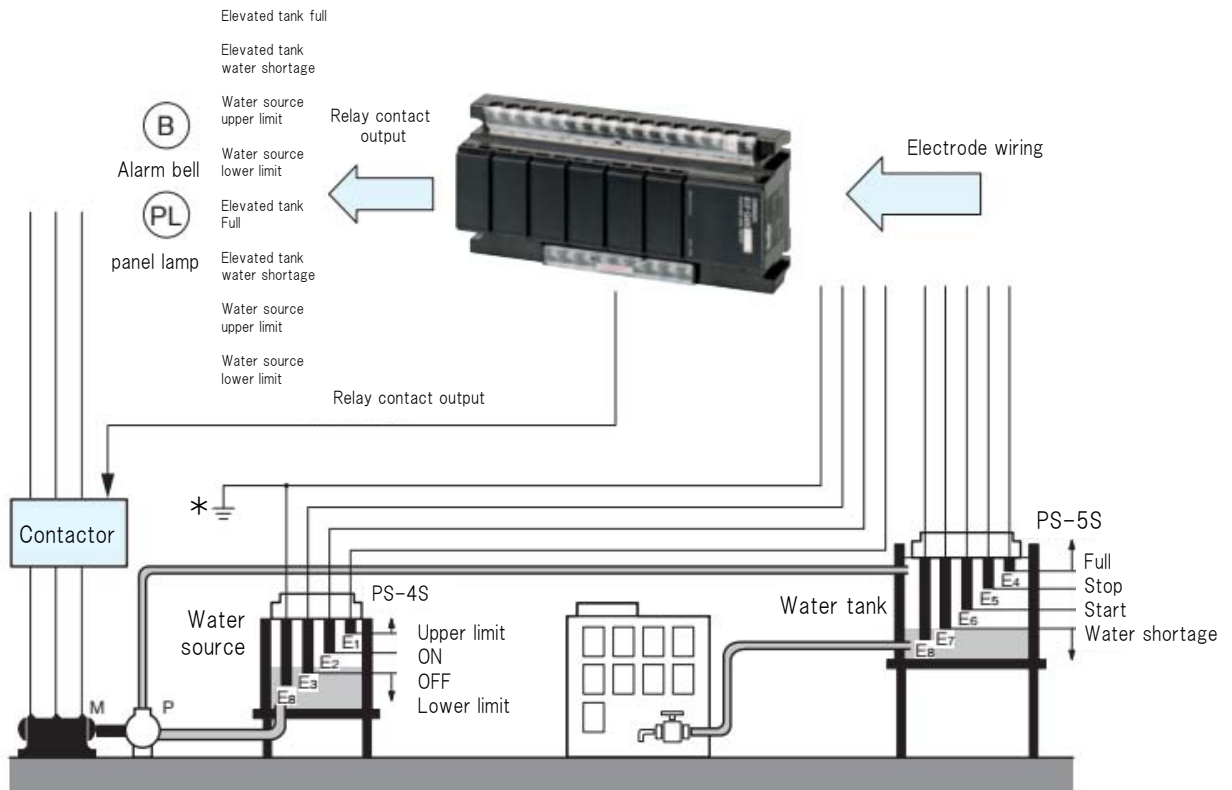

*Make sure that the common pole (the longest Electrode) is grounded securely.



First choice.

Model	Level Controller model number
Compact Controller	61F-G4N (100/200 VAC)
Basic Controller	61F-G4 (100/200 VAC)

Relay Unit Layout

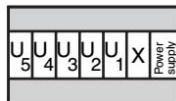

Principles of Operation

- The lower-limit indicator for the water supply source remains ON while the water source level is below E₃ (U₂ indicator OFF).
- When the water level rises to E₂, the lower-limit indicator turns OFF (U₂ indicator ON) and the pump is ready for operation.
- When the water level reaches E₁, the upper-limit indicator turns ON (U₃ indicator ON).
- The water-shortage indicator for the elevated tank remains ON while the water level in the elevated tank is below E₇. The indicator turns OFF (U₁ indicator ON) when the water level rises to E₇.
- The pump stops (U₅ indicator ON) when the water level reaches E₅ and starts (U₅ indicator OFF) when the water level drops below E₆.
- If the water level reaches E₄ for any reason, the tank repletion indicator for the elevated tank turns ON (U₄ indicator ON).

Timing Chart

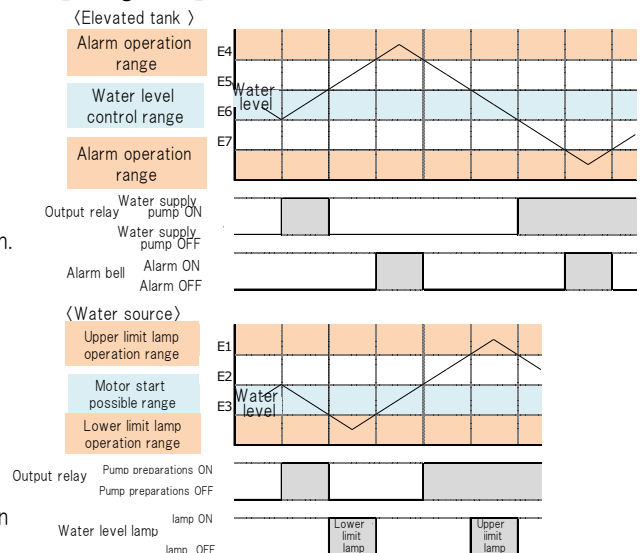

Selecting Level Controllers Based on the Application

10. Water Level Indicators and Alarms (with No Automatic Water Supply and Discharge Operation)

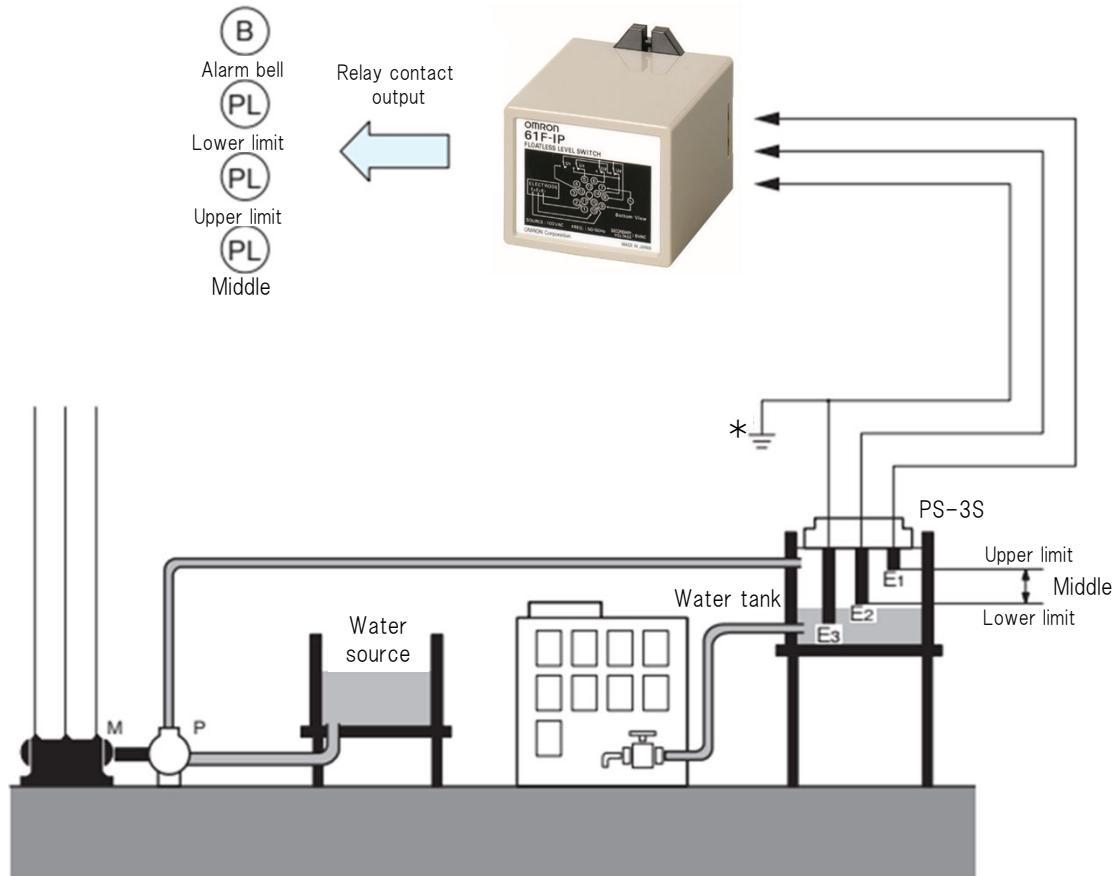

*Make sure that the common pole (the longest Electrode) is grounded securely.



First choice.

Model	Level Controller model number
Plug-in Controller with 14 pins	61F-IP (100 VAC) 61F-IP (200 VAC)
Compact Controller	61F-IN (100/200 VAC)
Basic Controller	61F-I (100/200 VAC)

Principles of Operation



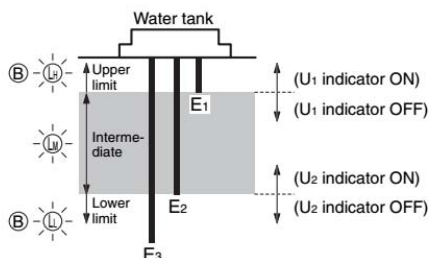



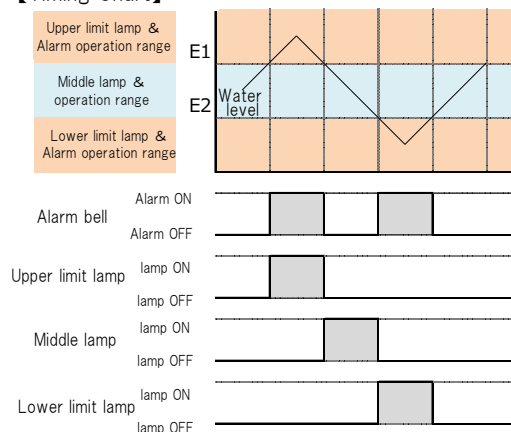



- When the water level drops below E₂, the lower-limit indicator turns ON and an alarm is given (U₂ indicator OFF).
- When the water level reaches E₂, the alarm turns OFF and the intermediate indicator turns ON (U₂ indicator ON).
- When the water level rises to E₁, the upper limit indicator turns ON and an alarm is given (U₁ indicator ON).



Timing Chart









Selecting a Level Controller Based on the Application or Application Environment

Item	Type	G Type	G1 Type	G2 Type	G3 Type
Applic- ation	Automatic Water Supply Operation	○	○	○	○
	Automatic Water Discharge Operation	○ *1		○ *1	○ *1
	Prevention of Operating Pump Dry				
	Abnormal Low Level Alarm		○		○
	Abnormal High Level Alarm		○ *2	○	○
	Water Level Control in Receiving Tank and Monitoring Water Source for Abnormal Levels				
	Level Display and Upper/Lower Limit Alarms		○ *2		
	Alternative Operation for Two Pumps				
Appea- rance	Compact Level Controllers (JEM size)	 61F-GN	 61F-G1N	 61F-G2N	 61F-G3N
	Basic Controllers	 61F-G	 61F-G1	 61F-G2	 61F-G3
	Compact, Plug-in Controllers	 61F-LS	—	—	—
	Plug-in Controllers	—	 61F-G1P	 61F-G2P	—
Features		Most general-purpose Level Controllers.	Supply-only Level Controllers that prevent pump idling.	Powerfully prevents abnormal water increase.	Powerfully prevents abnormal water increase and shortage.
Series	General purpose, 1 km *6	○	○	○	○
	Long distance for 2 km *6	○	○	○	○
	Long distance for 4 km *6	○	○	○	○
	High-sensitivity application	○	○	○	○
	Super-high-sensitivity application				
	Low-sensitivity application	○	○	○	○
	High-temperature application	○	○ *3	○ *3	○
	Tropical environment	○ *4	○ *4	○ *4	○ *4
	Heat resistance (under Japanese fire laws)				
Two-wire connection	○ *8	○ *7	○ *7	○	

- *1. The wiring can be changed to select supply or discharge.
- *2. Can be used to prevent operating dry or abnormal low level applications.
- *3. This does not apply to the 61F-G□N and 61F-G□P.
- *4. Models for tropical environments are available only for Basic Controllers and Compact Plug-in Controllers with 11 pins.
- *5. UHS only.
- *6. The length when using completely insulated, 600-V, 3-conductor (0.75 mm²) cabtyre cables. Usable cable lengths will become shorter as the cable diameter or number of conductors becomes larger.
- *7. This does not apply to the 61F-G1P and 61F-G2P.
- *8. The 61F-LS does not have the two-wire connection series.

Selecting a Level Controller Based on the Application or Application Environment

Item	Type	G4 Type	I Type	UHS and HSL Types
Applica-tion	Automatic Water Supply Operation	○		○ *5
	Automatic Water Discharge Operation			○ *5
	Prevention of Operating Pump Dry	○		
	Abnormal Low Level Alarm	○		
	Abnormal High Level Alarm	○		
	Water Level Control in Receiving Tank and Monitoring Water Source for Abnormal Levels	○		
	Level Display and Upper/Lower Limit Alarms	○	○	
	Alternative Operation for Two Pumps			
Appear-ance	Compact Level Controllers (JEM size)	 61F-G4N	 61F-IN	—
	Basic Controllers	 61F-G4	 61F-I	—
	Compact, Plug-in Controllers	—	—	—
	Plug-in Controllers	—	 61F-IP	 61F-UHS, 61F-H
Features		All functions for constant level control and level display alarms.	Level display and easy-to-use alarms.	Ideal for level control of fluid with very low electrical conductivity.
Series	General purpose, 1 km*6	○	○	○
	Long distance for 2 km*6	○	○	
	Long distance for 4 km *6	○	○	
	High-sensitivity application	○	○	
	Super-high-sensitivity application	○		
	Low-sensitivity application	○	○	
	High-temperature application	○	○ *3	
	Tropical environment	○ *4	○ *4	
	Heat resistance (under Japanese fire laws)			
	Two-wire connection	○	○	

*1. The wiring can be changed to select supply or discharge.
 *2. Can be used to prevent operating dry or abnormal low level applications.
 *3. This does not apply to the 61F-G□N and 61F-G□P.
 *4. Models for tropical environments are available only for Basic Controllers and Compact Plug-in Controllers with 11 pins.
 *5. UHS only.
 *6. The length when using completely insulated, 600-V, 3-conductor (0.75 mm²) cabtyre cables. Usable cable lengths will become shorter as the cable diameter or number of conductors becomes larger.
 *7. This does not apply to the 61F-G1P and 61F-G2P.
 *8. The 61F-LS does not have the two-wire connection series.

Control and Detection Applications of Water Level Controllers

The specific resistances (typical values) of the most common types of ‘water’ for which level control is used are given below along with the Level Controllers that can be used for each.

O: Detection possible.

Advantage: There is a lower chance of false operation for leakage currents. Long-distance wiring is possible.

Advantage: Liquids with high resistance can also be detected.

Disadvantage: Only liquids with a low resistance can be detected.

Disadvantage: There is a greater chance of false operation for leakage currents. Long-distance wiring is not possible.



Type	Long distance to 4 km	Long distance to 2 km	Low-sensitivity Controller	General-purpose Controller	High-sensitivity Controller	Super-high-sensitivity Controller	
Specific resistance (Ω·cm)	5k or less	10k or less	10k or less	30k or less	30k to 300k	100k to 10M	
Detected liquid	Tap water (5k to 10k)	—	○	⊙	—	—	
	Well water (2k to 5k)	○	○	○	⊙	—	
	Rainwater (15k to 25k)	—	—	○	⊙	—	
	Sewage (0.5k to 2k)	○	○	○	⊙	—	
	Sea water (0.03k)	○	○	○	⊙	—	
	Distilled water (250k to 300k or higher)	—	—	—	—	○	○
	Chemicals	The specific resistance of chemicals varies with the concentration. Check the specific resistance based on the chemical concentration. Refer to NTLPxREF Specific Resistances of Liquids on the next page. Some chemicals will cause the Electrodes to corrode. Select the best Electrodes based on their resistance to corrosion. Refer to Appendix Table 4 Electrode Resistance to Corrosion by Various Liquids on page 33.					
	Oils	The specific resistances of oils is too high, so they cannot be detected even with Super-high-sensitivity Controllers. Level control of oils is therefore not possible. Note: Mineral oil: 10 to the power of 10 = 10,000 MΩ·cm					
	Viscous liquids	Viscous liquids can be detected if their specific resistance is suitable, but even after the surface of the liquid drops, the liquid adheres to the Electrodes, resulting in unnecessary operation due to conduction between adjacent Electrodes. Level control of viscous liquids is therefore not possible.					
	Powders	Powders can be detected if their specific resistance is suitable, but humidity or other factors will cause them to adhere to the Electrodes, preventing normal level detection. Level control of powders is therefore not possible.					

The specific resistances (typical values) of typical liquids are provided on the next pages. Use them as reference when you select a Level Controller.

Control and Detection Applications of Water Level Controllers

<61F Series>

Infrastructure water level control or detection (buildings, storage ponds, rivers, etc.)

Reference Data: Specific Resistances of Various Liquids

Type	Temperature (°C)	Concentration (%)	Specific resistance (Ω · cm)
Beer (company A)	12	—	830.0
Port wine (company K)	12	—	966.0
Whiskey (company T)	12	—	14,608.0
Sake (company K grade 1)	12	—	1,743.0
Nitric acid (AgNO ₃)	18	5.0	39.5
		60.0	4.8
Barium hydroxide Ba(OH) ₂	18	1.25	40.0
		2.5	20.9
Calcium chloride (CaCl ₂)	18	5.0	15.6
		20.0	5.8
		35.0	7.3
Cadmium chloride (CdCl ₂)	18	1.0	181.0
		20.0	33.5
		50.0	73.0
Cadmium sulfate (CdSO ₄)	18	1.0	240.0
		5.0	68.5
		35.0	23.8
Nitric acid (HNO ₃)	18	5.0	3.9
		31.0	1.3
		62.0	2.0
Phosphoric acid (H ₃ PO ₄)	15	10.0	17.7
		60.0	5.5
		87.0	14.1
Sulfuric acid (H ₂ SO ₄)	15	5.0	4.8
		30.0	1.4
		50.0	12.5
		5.0	117.6
Potassium bromide (KBr)	15	21.0	14.5
		5.0	2.9
Calcium chloride (KCl)	18	36.0	14.5
		5.0	3.6
Potassium chlorate (KClO ₃)	15	99.4	27.2
Potassium cyanide (KCN)	18	30.0	19.0
		97.0	9.8
Potassium carbonate (K ₂ CO ₃)	15	5.0	17.8
		5.0	4.5
		3.25	6.8
Potassium fluoride (KF)	15	6.5	15.3
		40.0	4.0
Potassium iodide (KI)	15	5.0	31.4
		55.0	2.4
Potassium nitrate (KNO ₃)	18	5.0	22.1
		22.0	6.2
Potassium hydroxide (KOH)	18	4.2	6.8
		33.6	1.9
		42.0	2.4
Potassium sulfide (K ₂ S)	18	3.18	11.8
		29.97	2.2
		47.26	3.9

Type	Temperature (°C)	Concentration (%)	Specific resistance (Ω · cm)
Copper sulfate (CuSO ₄)	18	2.5	92.6
		17.5	21.8
Ferrous sulfate (FeSO ₄)	18	0.5	65.0
		3.0	21.7
Hydrogen bromide (HBr)	15	5.0	5.2
		15.0	2.0
Hydrochloric acid (HCl)	15	5.0	2.5
		20.0	1.3
		40.0	1.9
Hydrogen fluoride (HF)	18	0.004	4,000.0
		0.015	2,000.0
		0.242	275.0
		29.8	2.9
Mercuric chloride (HgCl ₂)	18	0.229	22,727.0
		5.08	2,375.0
Hydrogen iodide (HI)	15	5.0	7.5
		—	—
Potassium sulfate (K ₂ SO ₄)	18	5.0	21.8
		10.0	11.6
Sodium chloride (NaCl)	18	5.0	14.9
		25.0	5.6
Sodium carbonate (Na ₂ CO ₃)	18	5.0	22.2
		15.0	12.0
Sodium iodide (NaI)	18	5.0	33.6
		40.0	4.7
Sodium nitrate (NaNO ₃)	18	5.0	22.9
		30.0	6.2
Sodium hydroxide (NaOH)	15	2.5	9.2
		20.0	2.9
		42.0	8.4
Sodium sulfate (Na ₂ SO ₄)	18	5.0	24.4
		15.0	11.3
Ammonia (NH ₃)	15	0.1	3,984.0
		4.01	913.0
		3.05	5,181.0
Ammonium chloride (NH ₄ Cl)	18	5.0	50.5
		25.0	2.5
Ammonium nitrate (NH ₄ NO ₃)	15	5.0	16.9
		50.0	2.7
Ammonium sulfate ((NH ₄) ₂ SO ₄)	15	5.0	18.1
		31.0	4.3
Zinc chloride (ZnCl ₂)	15	2.5	36.2
		30.0	10.8
		60.0	27.1
Zinc sulfate (ZnSO ₄)	18	5.0	52.4
		30.0	22.5

Reference: Measurement Method for Resistance between
If you do not know the specific resistance of the liquid to be detected, you can measure the resistance between Electrodes with the following formula and a tester.

$$R = \frac{V}{I}$$

R: Resistance of liquid between Electrodes (k Ω)
V: Voltage shown on voltmeter (V)
I: Current shown on ammeter (mA)
Use the value of R to select the 61F model.

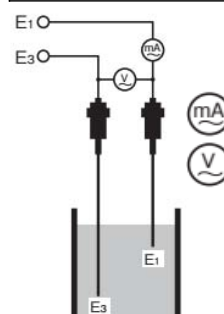

Use an ammeter that can be accurately read to around 1 mA with as low of an impedance as possible.
Use a voltmeter that can be read to within a few volts with as high of an impedance as possible.

Selecting Level Controllers Based on the Application

It is best to use the K8DT-LS or K8AK-LS for installations where saving space is required, such as in industrial equipment or inside equipment.
(Sensitivity : 10-100k Ω)

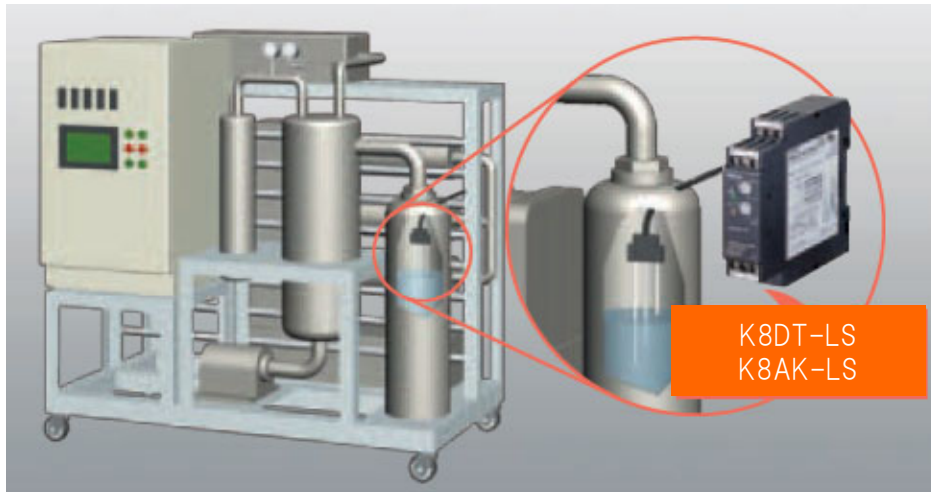

K8DT-LS
K8AK-LS

K8DT-LS

K8AK-LS

61F Compact



First choice



Extremely thin!
Width of 17.5 mm
Transistor Output
available

Slim Design!
Width of 22.5 mm

Plug-in Controller:
Width of 38.0 mm

If **frequent operation** is required for automatic water supply and discharge, **we recommend that you use transistor outputs**, which provide higher contact reliability. Relay outputs will deteriorate, and transistors have a high contact reliability.

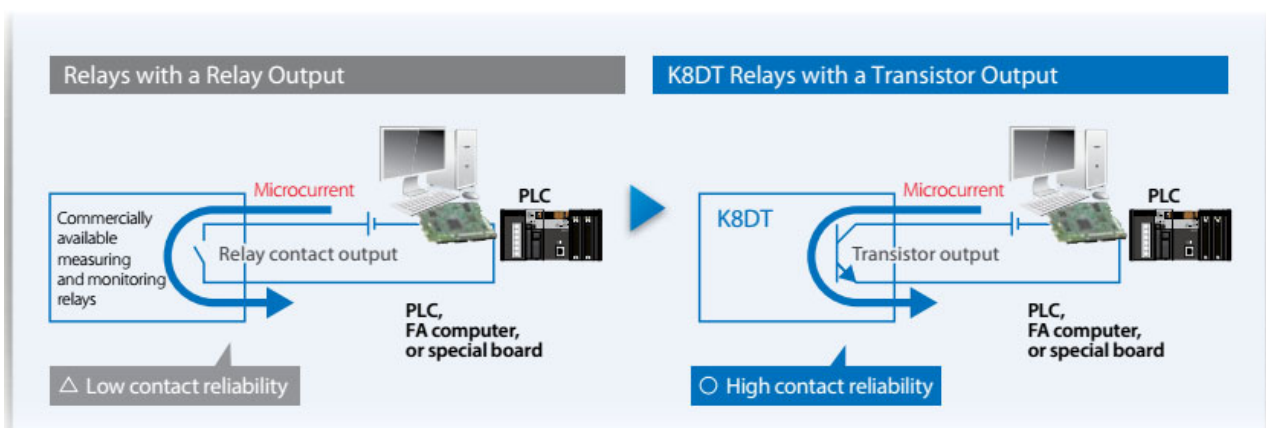

Selecting Electrode Holders

General Applications:
For Example, for Tap Water



Electrode Holders

The model number is determined by the number of Electrodes.

Electrode Holder	Model number of Electrode Holder for general use	Model number of Electrode Holder with 2-wire connection (Used when 61F Controller has 2-wire connection)
For 3 Electrodes	PS-3S	PS-3SR
For 4 Electrodes	PS-4S	PS-4SR
For 5 Electrodes	PS-5S	PS-5SR

Integrated Electrode Holder and Electrodes

Electrode Holder	Model of Integrated Holder and Electrodes	Electrode material
For 3 Electrodes (Electrode length: 0.3 m, thickness: 4 mm)	PS-31 300mm	SUS304
For 3 Electrodes (Electrode length: 1 m, thickness: 4 mm)	PS-31 1000mm	SUS304

The Holder is smaller than the PS-3S.

Models are not available for 4 or 5 Electrodes.

The Electrodes cannot be extended, removed, or replaced.

Only Electrodes made of SUS304 are available.

The Electrodes are available only in lengths of 300 mm and 1,000 mm.

You can cut the Electrodes to the required length.

Use the BF and BS for the following applications.



- Applications at high temperatures or high pressures
- Applications that require greater mounting strength
- Applications where resistance to corrosion is necessary
- Applications for liquids with low specific resistances (liquids that easily pass electricity), such as sea water

Selecting Electrode Holders

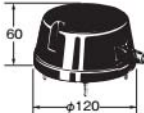
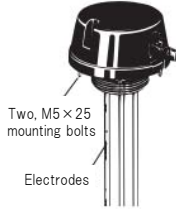
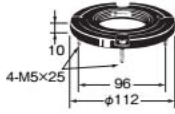
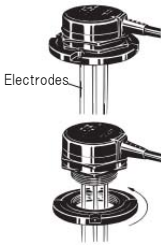
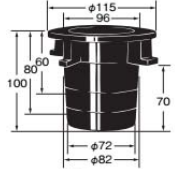
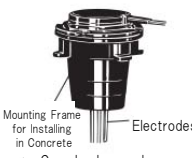
Options for PS-□S(R) Electrode Holders (Sold Separately)

Name	Model number	Applicable Holder	Appearance	Application example	Description
Protective Cover	F03-11	PS-3S PS-4S PS-5S PS-3SR PS-4SR PS-5SR	 <p>Ambient operating temperature: -10 to 70° C. Weight: Approx. 65 g</p>	 <p>Two, M5×25 mounting bolts Electrodes</p>	If you use the PS-□S outdoors, you can screw in the F03-12 Mounting Frame to enable attaching the F03-11 Protective Cover. The cover is not waterproof, so water or dust may enter through the wire port.
Mounting Frame	F03-12		 <p>Ambient operating temperature: -10 to 70° C. Weight: Approx. 80 g</p>	 <p>Electrodes</p>	You can use this Frame as a flange for the PS-□S or as a nut to mount the Holder to an FRP tank or other tanks without threading.
Mounting Frame for Installing in Concrete	F03-13		 <p>Weight: Approx. 120 g</p>	 <p>Mounting Frame for Installing in Concrete Electrodes Can also be used as a Mounting Frame.</p>	This Frame is useful for embedding in concrete. Screw the F03-12 Mounting Frame into the PS-□S, and then attach it to the F03-13. Cut the Frame to the required concrete depth.

Options for PS-31 Integrated Holder and Electrodes (Sold Separately)

Name	Model number	Applicable Holder	Appearance	Application example	Description
Dust-proof Rubber Cap	F03-31	PS-31	 <p>Material: Silicon rubber (black) Weight: Approx. 14 g</p>	 <p>F03-31 PS-31</p>	Attach the Cap from the top of the PS-31. This Cap is not waterproof.

Selecting Electrode Holders

Applications for Sewage, Salt Water, Acidic Chemicals, High Temperatures, High Pressures, Etc.

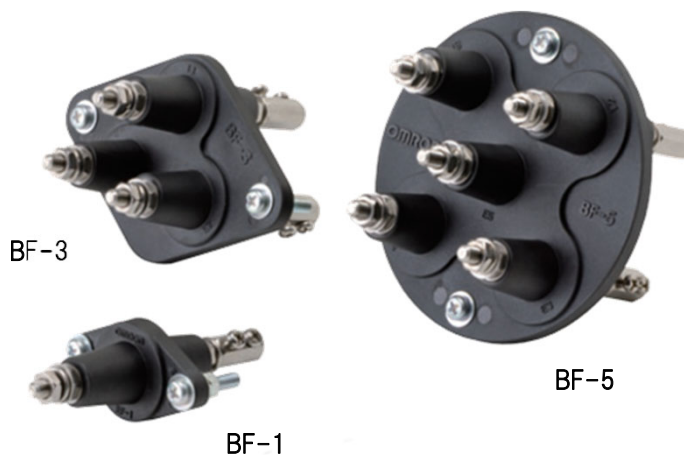

For Liquids with Low Specific Resistance

With sewage or other liquids with a low specific resistance, the interval between Electrodes must be increased, so multiple individual Electrodes are used.

	Electrode Holder model
For 1 Electrode	BF-1

Increased Mounting Strength

Use these Holders when the mounting strength of the general-use PS Holders is not sufficient.

Electrode Holder	Model number of Electrode Holder for general use	Model number of Electrode Holder with 2-wire connection (Used when 61F Controller has 2-wire connection)
For 3 Electrodes	BF-3	BF-3R
For 4 Electrodes (Manufacturing was discontinued from 2007.)	Use the Holder for 5 Electrodes.	Use the Holder for 5 Electrodes.
Use the Holder for 5 Electrodes.	BF-5	BF-5R

Selecting Electrode Holders

Applications for Sewage, Salt Water, Acidic Chemicals, High Temperatures, High Pressures, Etc.

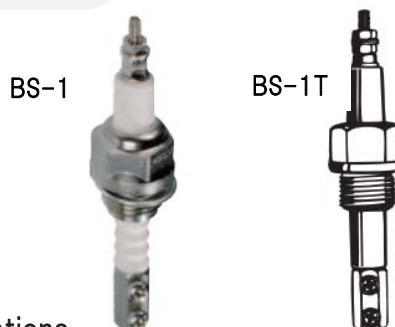

Holder for High-temperature or High-pressure Applications

	Electrode Holder model	Tightening section material	Thread specifications	Terminal bolt material
For 1 Electrode	BS-1	Iron	M18 P=1.5	SUS304
For 1 Electrode	BS-1S	SUS304	M18 P=1.5	SUS304
For 1 Electrode	BS-1S1	SUS304	PT1/2	SUS304
For 1 Electrode	BS-1S2	SUS316	M18 P=1.5	SUS304

Applications: High-temperature tanks, such as boilers. One Holder is required for each Electrode. Models are not available for 3, 4, or 5 Electrodes.

	Electrode Holder model	Tightening section material	Thread specifications	Terminal bolt material
For 1 Electrode	BS-1T SUS304	Fluororesin	M18 × 1.5	SUS304
For 1 Electrode	BS-1T SUS316	Fluororesin	M18 × 1.5	SUS316
For 1 Electrode	BS-1T TITANIUM	Fluororesin	M18 × 1.5	Titanium
For 1 Electrode	BS-1T HAS B	Fluororesin	M18 × 1.5	HAS B
For 1 Electrode	BS-1T HAS C	Fluororesin	M18 × 1.5	HAS C

Applications: Acidic or alkali liquids. One Holder is required for each Electrode. Models are not available for 3, 4, or 5 Electrodes.

	BS-1 Series	BS-1T Series
Operating temperature	250°C max	180°C max.
Operating pressure	1.96M Pa max	981kPa max.

For applications under high pressure, steam leakage can occur if the ambient temperature is not high. Use the upper left part of the curve on the graph.

Pressure vs Temperature Rise Curve

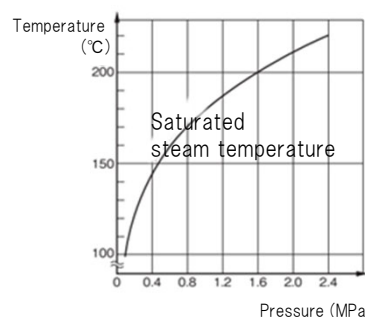

Accessories (Order Separately)

The M18 Nuts are used to mount Holders to tanks without threading. Application is not possible if resistance to pressure is required.

	Model number	Applicable Holder	
Protective Cover	F03-11	BF-3, BF-3R BF-5, BF-5R	
M18 Nut	F03-17	BS-1 Series	Material: SUS316
M18 Nut	F03-18	BS-1T Series	Material: Fluororesin

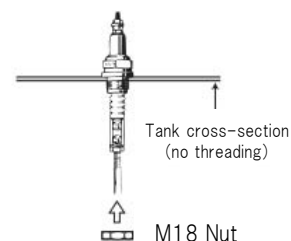

Selecting Electrodes

Select the Electrode material according to the type of liquid.
 If there is a long distance between the Holder and the water surface (e.g., a deep well), use an Electrode Band or Underwater Electrode.
 If there is no installation space for a Holder, use an Underwater Electrode.



Selecting Electrodes

Use **SUS304** for general liquids, such as clean water.

Material	Model (Notation in parentheses is for the same model.)	Distinguishing materials
SUS304	F03-01 SUS304 (F03-01 SUS304 ELECTRODE)	1 line
SUS316	F03-01 SUS316 (F03-01 SUS316 ELECTRODE)	2 lines
N10665 (HAS B)	F03-01 HAS B (F03-01 HAS B ELECTRODE)	3 lines
N10276 (HAS C)	F03-01 HAS C (F03-01 HAS C ELECTRODE)	4 lines
Titanium	F03-01 TITANIUM (F03-01 TITANIUM ELECTRODE)	5 lines

M6

Material indication lines

The Electrodes are 1 m long and can be connected to up to 5 m.
 You can cut the Electrodes to the required length.

Sheathed Electrodes

These Electrodes can be used to prevent false operation caused by conductivity between Electrodes results from adhering material.

Electrode material	Sheath material	Model (Notation in parentheses is for the same model.)	Distinguishing materials
SUS304	Vinyl	F03-01 SUS304 Vinyl Tubing (F03-01 SUS304 BINIL)	1 line
SUS304	Fluororesin	F03-01 SUS304 Fluororesin Tubing (F03-01 SUS304 Fluoroplastic)	2 lines
SUS316	Vinyl	F03-01 SUS316 Vinyl Tubing (F03-01 SUS316 BINIL)	3 lines
SUS316	Fluororesin	F03-01 SUS316 Fluororesin Tubing (F03-01 SUS316 Fluoroplastic)	4 lines

M6

Material indication lines

Sheath color: Vinyl: Gray
 Fluororesin: Milky white

Electrodes can be connected to up to 5 m.
 However, if the length is extended, the connection between Electrodes will not be sheathed.
 (Connecting Nuts with sheathing are not available.)
 You can cut the Electrodes to the required length.
 Remove 10 cm of the sheathing from the end of the Electrodes when you use them.
 For applications, Lock Nuts and Connecting Nuts are required in addition to the Electrodes.
 Refer to next page for details.

Selecting Electrodes

Selecting Connecting Nut and Lock Nuts for Electrodes

- One Lock Nut is required to connect an Electrode to an Electrode Holder.
- To extend the Electrode length, two Lock Nuts and one Connecting Nut are required.
- If you extend the Electrode length, also use Separators to prevent adjacent Electrodes from coming into contact with each other.

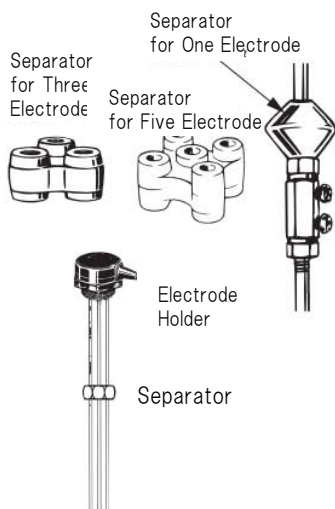
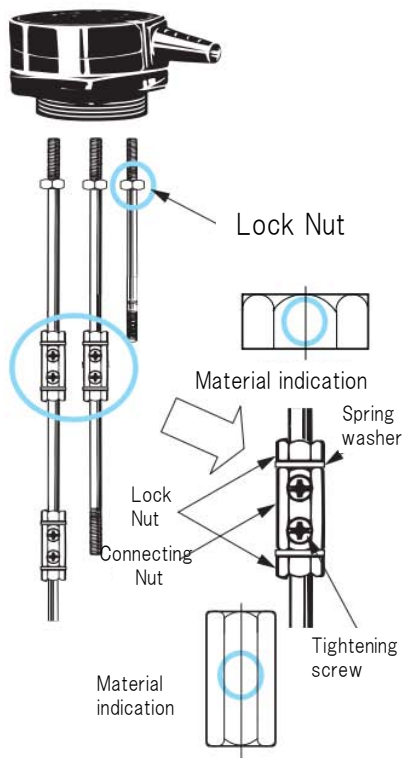

Lock Nuts (Select Lock Nuts with the same material as the Electrodes.)

Material	Model number	Material indication	Spring washer
SUS303 (Equivalent to SUS304)	F03-03 SUS304	None	Provided
SUS316	F03-03 SUS316	6	Provided
N10665 (HAS B)	F03-03 HAS B	B	None
N10276 (HAS C)	F03-03 HAS C	C	None
Titanium	F03-02 TITANIUM	T	None

Only Lock Nuts are required to connect Electrodes without spring washers.

Connecting Nuts (Select Connecting Nuts with the same material as the Electrodes.)

Material	Model number	Material indication	Tightening screws
SUS303 (Equivalent to SUS304)	F03-02 SUS304	None	Provided
SUS316	F03-02 SUS316	6	Provided
N10665 (HAS B)	F03-02 HAS B	B	None
N10276 (HAS C)	F03-02 HAS C	C	None
Titanium	F03-02 TITANIUM	T	None

Only Lock Nuts are required to connect Connecting Nuts that do not have tightening screws.

Separators (Select according to the model of the Holder and number of Electrodes.)

	Model number	Applicable Holders
For 1 Electrode	F03-14 1P	BF-1, BF-3, BF-3R, BF-5, BF-5R
For 3 Electrodes	F03-14 3P	PS-3S, PS-3SR
For 5 Electrodes	F03-14 5P	PS-4S, PS-4SR, PS-5S, PS-5SR

Material: Ceramic. Separators are not available for 4 Electrodes. Use the Separator for 5 Electrodes. Install above the Connecting Nut. If there is no Connecting Nut, the Separator will slide down and fall off.

Selecting Electrodes

Selecting Electrodes Based on Corrosion Resistance

Electrodes are used for a long period of time. Refer to Appendix Table 4 and select the best material.

Appendix Table 4 Electrode Resistance to Corrosion by Various Liquids

Solution in water			Electrode material				
Type	Concentration (%)	Temperature (°C)	SUS 304	SUS 316	Titanium	HAS B	HAS C
Sulfurous acid (H ₂ SO ₃)	6	30	E	C	A	B	B
Sulfuric acid (H ₂ SO ₄)	1	30	A	A	A	A	A
	1	BP	E	D	E	B	C
	3	30	B	A	A	A	A
	3	BP	E	E	E	C	C
	5	30	D	B	D	B	A
	5	BP	E	E	E	D	D
	10	30	E	C	E	A	A
	10	BP	E	E	D	C	E
	20	30	E	E	C	C	B
	20	BP	E	E	D	D	E
	40	30	E	E	D	B	B
	40	BP	E	E	D	E	E
	60	30	E	E	D	B	C
	60	BP	E	E	D	C	D
	70	30	E	E	D	B	B
	70	BP	E	E	D	C	D
	80	30	E	E	D	B	B
	80	BP	E	E	D	D	D
	90	30	E	E	D	B	B
	90	BP	E	E	D	D	D
95	30	E	D	D	B	B	
95	BP	E	E	D	D	D	
Hydrochloric acid (HCl)	1	30	E	D	B	B	A
	1	BP	E	E	E	D	C
	3	30	E	E	B	B	A
	3	BP	E	E	E	D	C
	5	30	E	E	C	C	A
	5	BP	E	E	E	E	D
	10	30	E	E	E	C	C
	10	BP	E	E	E	E	E
	15	30	E	E	E	C	C
	15	BP	E	E	E	E	E
	20	30	E	E	E	C	D
	20	BP	E	E	E	E	E
	37	30	E	E	E	C	E
	37	BP	E	E	E	E	E
	10	BP	D	C	A	B	C
Chromic acid (CrO ₃)	20	30	C	B	A	B	B
	36.5	90	E	E	C	C	C
	10	30	B	A	A	D	A
Nitric acid (HNO ₃)	10	BP	B	B	B	D	C
	20	290	B	B	C	D	D
	65	175	C	C	B	E	E
	68	30	C	C	A	D	D
	68	BP	D	D	B	E	E
90	80	E	E	A	E	E	
Hydrogen fluoride (HF)	5	30	E	E	D	D	C
	100	30	E	D	C	C	C
Phosphoric acid(H ₃ PO ₄)	10~85	RT	B	B	C	B	C

Solution in water			Electrode material				
Type	Concentration (%)	Temperature (°C)	SUS 304	SUS 316	Titanium	HAS B	HAS C
Acetic acid (CH ₃ COOH)	5 to 50	RT	A	A	A	A	A
	100	RT	A	A	A	A	A
	100	BP	C	B	A	A	A
Formic acid (HCOOH)	Any	BP	D	D	D	A	A
Acetone ((CH ₃) ₂ CO)	Any	RT	B	B	A	A	A
Aluminium potassium sulfate	Any	RT	E	E	D	B	B
Aluminium sulfate	50	BP	D	C	B	C	A
Ammonium chloride (NH ₄ Cl)	5	BP	D	D	A	B	B
Ammonium nitrate (NH ₄ NO ₃)	Any	BP	A	A	A	B	B
Ammonium sulfate ((NH ₄) ₂ SO ₄)	5	RT	E	D	B	B	C
	10	BP	E	E	B	B	C
Ammonia (NH ₃)	100	100	C	C	A	B	B
	10	BP	C	B	B	B	C
	28	60	C	B	A	B	B
Potassium hydroxide (KOH)	25	BP	B	A	C	B	C
Sodium hydroxide (NaOH)	30	60	A	A	B	A	B
	50	65	B	A	C	A	C
Sodium carbonate (Na ₂ CO ₃)	25	BP	B	B	B	B	B
Potassium carbonate (K ₂ CO ₃)	20	BP	B	B	B	B	B
Zinc chloride (ZnCl ₂)	50	150	D	C	B	B	C
Calcium chloride (CaCl ₂)	25	BP	C	C	A	A	A
Sodium chloride (NaCl)	25	BP	C	B	A	B	B
Ferric chloride	30	RT	E	E	A	E	B
Cupric chloride	30	RT	E	E	A	E	B
Sea water		RT	C	C	A	B	A
Hydrogen peroxide (H ₂ O ₂)	10	RT	B	B	B	B	B
Sodium sulfite	10	RT	B	B	A	B	B
Citric acid	Any	RT	B	A	C	A	A
Oxalic acid (C ₂ H ₂ O ₄)	Any	RT	B	A	D	B	B
Sodium hypochlorite	10	RT	E	D	A	C	C
Potassium dichromate	10	BP	C	B	A	B	C
Magnesium chloride	30	RT	C	B	A	A	A
Magnesium sulfate	10	RT	B	B	A	A	A

Note1. RT: Room temperature

BP: Boiling point

Note2. A: Sufficient corrosion resistance

B: Corrosion resistance, corrosion rate: 0.8 mm/year max.

C: Inferior corrosion resistance, corrosion rate: 1.8 mm/year max.

D: Large corrosion rate, cannot be used.

E: No corrosion resistance, cannot be used.

Note3. Use the above table to select Electrodes based on resistance to corrosion. Keep in mind that some corrosion will occur even if the Electrodes are specified as corrosion resistant or as having sufficient corrosion resistance. Inspect the Electrodes once a month, check the corrosion conditions, and replace Electrodes sooner than later.

Reference: It is necessary to consider the resistance to corrosion of the electrode material of the Electrode Holder exposed in the tank. Consider that when you select the Electrode Holder.

Selecting Electrodes

Underwater Electrodes

Underwater Electrodes

Underwater Electrodes are used when there is a long distance to the water surface or there is not enough space to install a Holder.

Models are available with 1 pole or 2 poles.

Either vinyl or Hypalon cables are available.

Operating temperature: Vinyl: 10 to 60°C

Hypalon: -30 to 70°C

An Electrode Holder is **not necessary to use an Underwater Electrode**.

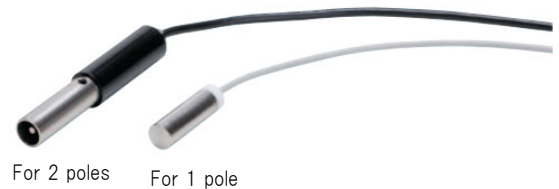

Type	Model number	Distinguishing materials	
For one pole, vinyl cable	PH-1	Cable color: Gray	Maximum cable length: 100 m Specify the cable length at the end of the model number. Example: PH-1 10M You can specify any of the following lengths: 1M, 5M, 10M, 15M, 20M, 30M, 40M, 50M, 60M, 70M, 80M, 90M, or 100M You can cut the cables as required.
For one pole, Hypalon cable	PH-1 HAIPREN	Cable color: Black “ハイブレン” is printed in Japanese on the cable.	
For two poles, vinyl cable	PH-2	Cable color: Black	
For two poles, Hypalon cable	PH-2 HAIPREN	Cable color: Black “ハイブレン” is printed in Japanese on the cable.	

Required Number of Underwater Electrodes

Short Distances between Electrodes

Use three, 1-pole Electrodes.

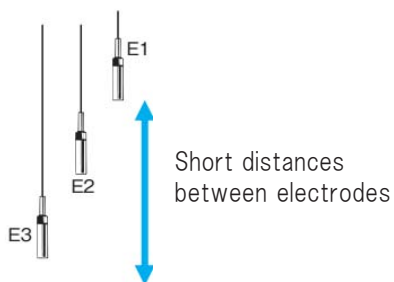

Long Distances between Electrodes

Use four, 1-pole Electrodes.

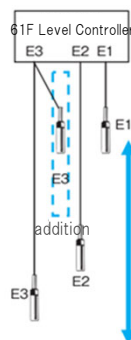

If the distance between Electrodes is too long, there may not be any conductivity between E1 and E3.

Add Electrode E3 near E1.

(Guideline: For clean water, add an E3 Electrode if the distance between Electrodes is 1 m or more.)

Long Distances between Electrodes

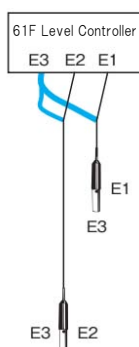

Using Two, 2-pole Electrodes: A 2-pole Underwater Electrode has two electrodes connected through one cable. (The water level detection heights are almost the same.) Wire one line from each Underwater Electrode to E3 and the other lines to E1 and E2. This will prevent false operation even if there is a long distance between the Electrodes. However, false operation will occur if foreign matter enters the detection section.

Additional Information

Maintenance

Recommended Replacement Period

As a guideline, replace the products every 7 to 10 years.
Earlier replacement may be required in some operating environments.

Replacing Relay Units

A Relay Unit is included when you purchase a 61F Compact or Basic Level Controller.
If it fails, you can replace only the Relay Unit.
After long-term usage, parts other than the Relay Unit will also have deteriorated, so replace the entire Level Controller.

	Relay Unit for Compact Controller	Relay Unit for Basic Controller
General-purpose Controller	61F-11N	61F-11
Long-distance for 2 km	61F-11NL 2KM	61F-11L 2KM
Long-distance for 4 km	61F-11NL 4KM	61F-11L 4KM
High-sensitivity Controller	61F-11NH	61F-11H
Low-sensitivity Controller	61F-11ND	61F-11D
Two-wire Controller	61F-11NR	61F-11R

Cleaning Electrodes

Electrodes must be cleaned.

At about six months after installation, remove the Electrodes and use fine sandpaper to remove film from the surface.
After that, clean the Electrodes once or twice a year.
If the Electrodes are used in liquid with a lot of dirt or scum, insulating film may form, particularly on the surfaces of the Electrodes, and result in operating failures.
Remove the insulating film once every three months.
For sewage tanks, sewage, oil film, or other applications with a lot of waste material, use a pipe such as the one shown below.

- Use a pipe with a diameter of at least four inches.
- Install the pipe with a diagonal cut at the end as shown in the figure at the right according to the estimated waste material accumulation.
- Provide an air ventilation hole with a diameter of approx. 10 mm on the upper part of the pipe.

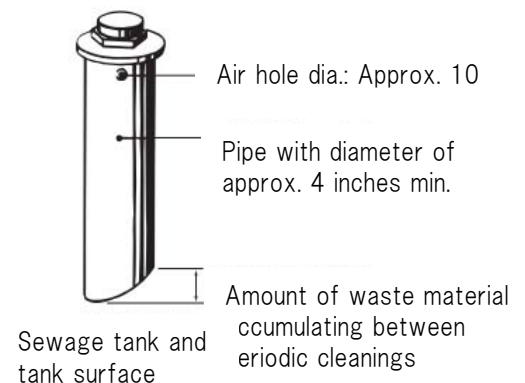

Additional Information

Peripheral Equipment

Protection for Motors and Pumps

Phase-sequence
Phase-loss Relays

K8DT-PH
K8AK-PH



Protect motors and pumps from unstable voltages in the power supply system. Also, protect motors and pumps by detecting phase sequence and phase loss for three-phase power supplies.

Causes of Failures

Wiring mistakes made when installing motors and pumps, wiring mistakes when changing equipment layout, contactor contact faults, and wires disconnected during motor operation

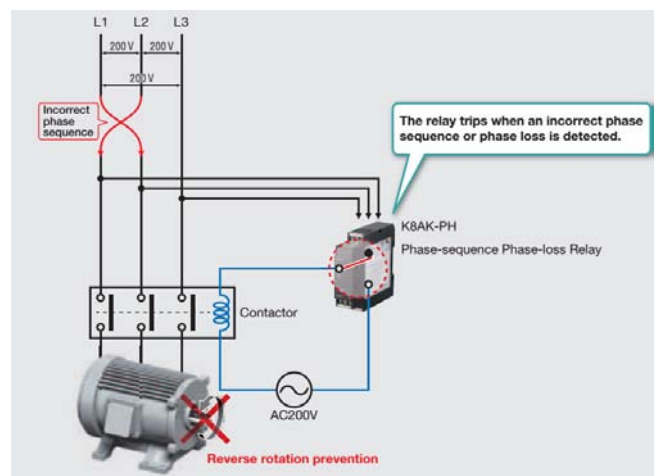

Single-phase Overcurrent/
Undercurrent Relays

K8DT-AW
K8AK-AW

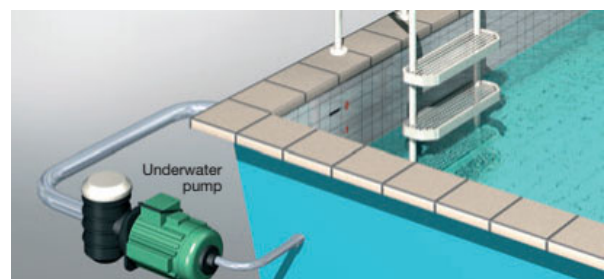

Provide protection by detecting errors in motors, pumps, and other equipment through current changes. Monitor for overcurrents and undercurrents simultaneously with one Relay.

Causes of Failures

Dry-operating pumps due to water shortage or overloads due to object entrapment

Products for Leakage Detection Applications

Equipment leakage detection in factory buildings

The K7L is ideal for detecting leakage in semiconductor manufacturing equipment, medical equipment, or other facilities that use water, or in server rooms, semiconductor plants, art museums, historical museums, or other locations subject to damage by water.

Detection of Condensation and Liquid Leakage at Semiconductor Production Installations

Detects condensation inside cleaning devices and liquid leaked to the surroundings.

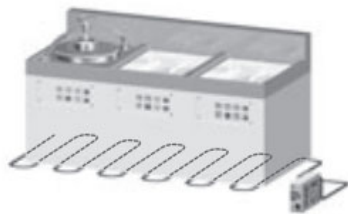

Liquid Leakage Detection for Measuring Baths in CMP Devices

Detects liquid leaked to drain pans, and prevents damage to devices and cleaning irregularities for wafers.



Detection of Liquid Leakage at Pipe Joints for Chemical Liquid Tanks

Liquid leakage at a pipe joint can be detected by wrapping the Sensing Band around the joint.







Floors and Ceilings for Semiconductor or FPD Plants



Floors under Chemical Generation Tanks



Sensor	K7L (Leakage Sensor)		Sensing Bands	Point Sensors
	Push-In terminals	Screw terminals		
Appearance				
Model numbers	K7L-AT50B K7L-AT50DB K7L-UB K7L-UDB	K7L-AT50 K7L-AT50D K7L-U K7L-UD	F03-16PE F03-16PT F03-15	F03-16PS F03-16PS-F
Features	Push-In terminals Note: Vertically reversed from previous K7L models.		Ribbon detection	Point detection
Socket	P2RF-08-PU	P2RF-08 P2RF-08-E	—	—
UL listing	© Note: Only when Push-in Socket is used with the Sensor.	×	—	—

Note: Do not use this document to operate the Unit.

OMRON Corporation Industrial Automation Company

Kyoto, JAPAN

Contact : www.ia.omron.com

Regional Headquarters

OMRON EUROPE B.V.

Wegalaan 67-69, 2132 JD Hoofddorp
The Netherlands
Tel: (31) 2356-81-300 Fax: (31) 2356-81-388

OMRON ELECTRONICS LLC

2895 Greenspoint Parkway, Suite 200
Hoffman Estates, IL 60169 U.S.A.
Tel: (1) 847-843-7900 Fax: (1) 847-843-7787

OMRON ASIA PACIFIC PTE. LTD.

438B Alexandra Road, #08-01/02 Alexandra
Technopark, Singapore 119968
Tel: (65) 6835-3011 Fax: (65) 6835-3011

OMRON (CHINA) CO., LTD.

Room 2211, Bank of China Tower,
200 Yin Cheng Zhong Road,
PuDong New Area, Shanghai, 200120, China
Tel: (86) 21-6023-0333 Fax: (86) 21-5037-2388

Authorized Distributor:

©OMRON Corporation 2017-2023 All Rights Reserved.
In the interest of product improvement,
specifications are subject to change without notice.

Cat. No. N217-E1-04 0623 (0322)