

Finder Option
for the MX-Z2000H Series
Fiber Laser Markers

OMRON

Give your Laser Marker the **Eyes** to Confirm Marking Quality

The same product enables position-compensated marking and data marked, including 2D codes inspection.

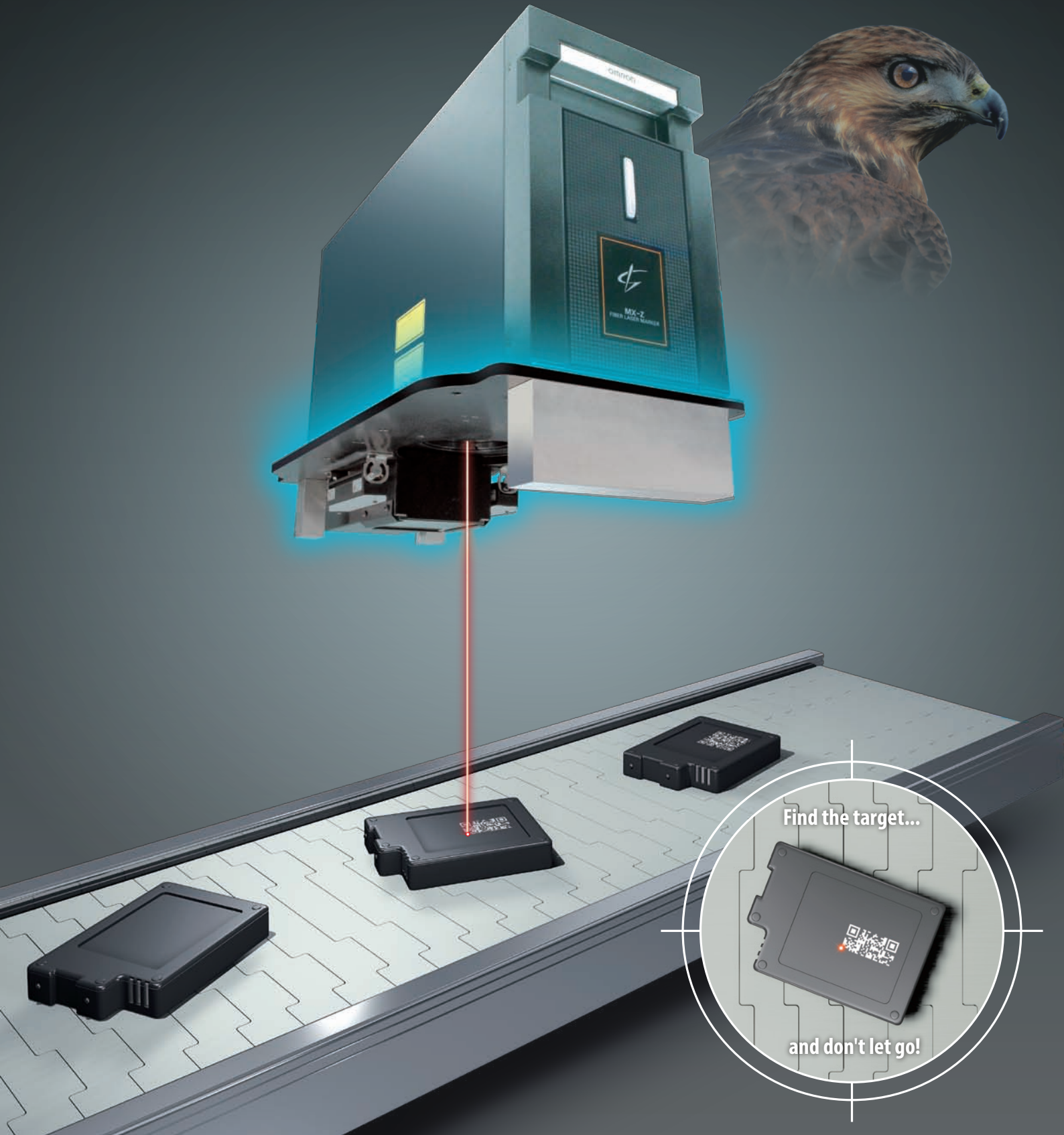

The Finder Option makes the MX-Z2000H series laser markers even easier to use!



Find the part, Mark it and Inspect it in the same position.
Position-compensated Marking, Inspection & Reading 2-D Codes, Display & Monitoring

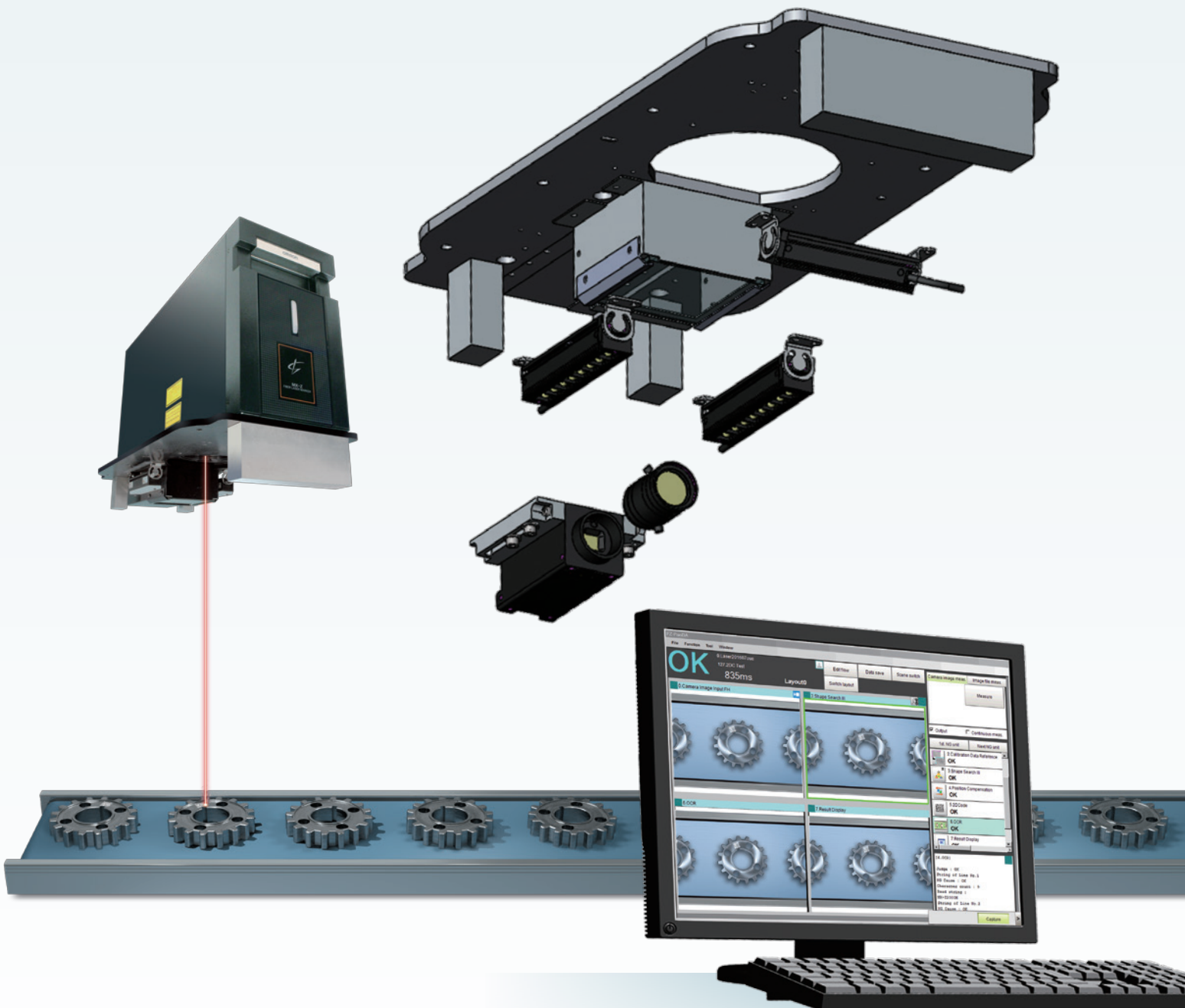

1

Position-compensated Marking

No mechanical position-compensation is needed.

Before There were many defects, producing low yields.

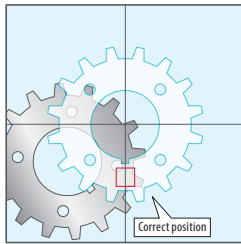

When parts were out of position...

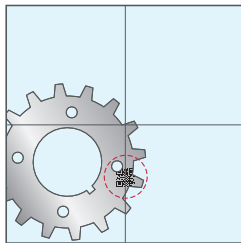

They were marked incorrectly, and defects were produced.

Now Position-compensation increases yields.

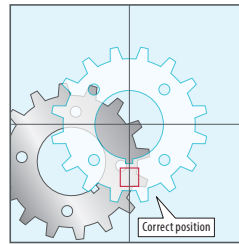

When parts are out of position...

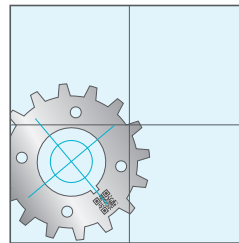

the camera obtains the actual position, and...

they are marked correctly.

Not only X and Y but also θ correction is possible.

Great Benefits

The camera confirming and compensating for the workpiece position makes position-compensation mechanisms unnecessary.

Jigs are not required even for multiple product types. The finder option contributes to both cost reductions and system simplification.

System Configuration for Position-compensation and inspection

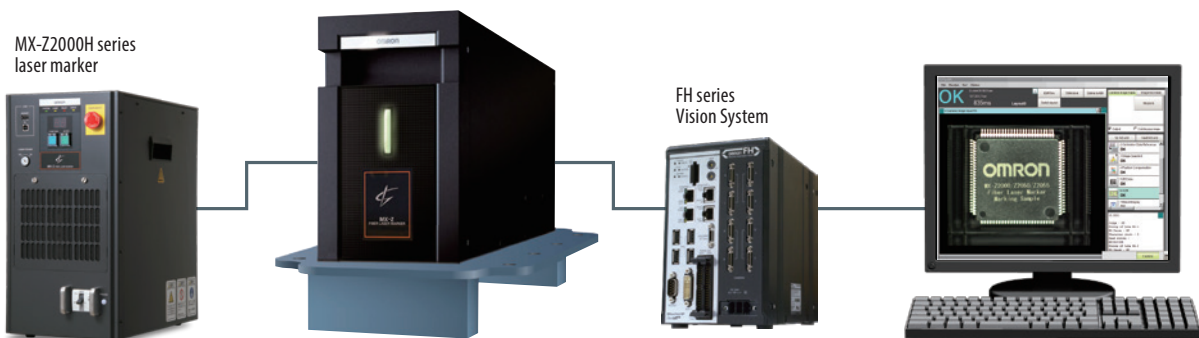

Finder Option

The finder option is the name of the finder system compatible with the MX-Z2000H series. It consists of the following products.

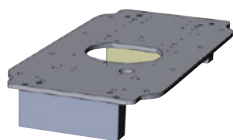

Camera attachment



Camera mount



Finder camera



Lens



Lighting



Note: Refer to pages 6 and 7 for device configuration details.

2

Inspection/Reading 2D Codes

Consolidate to a single process.

Before Various devices and processes were required.

Now All processes are consolidated in one single step.

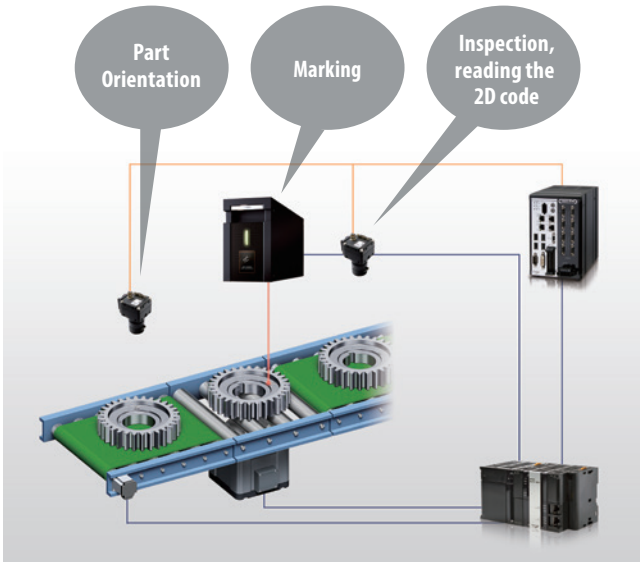

Cost and labor for the design, implementation and execution were high.

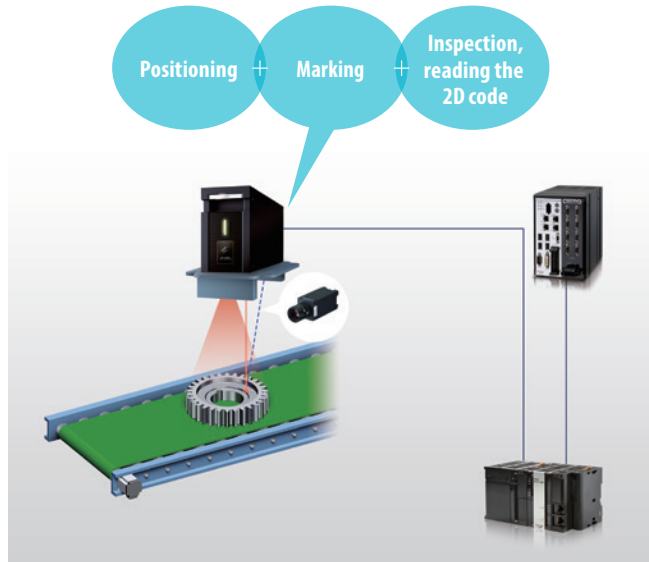

Design, implementation, and execution are greatly simplified.

Before

Camera(s)	2
Rotary positioning mechanism	1
Product indexing	3 positions
Hardware design	Normal
Software design	Normal
Rotation time	Yes

Now

Camera(s)	1
Rotary positioning mechanism	None
Product indexing	1 position
Hardware design	Simple
Software design	Simple
Rotation time	None

- Cameras decreased
- Rotary positioning gone
- Stop positions decreased
- Design effort reduced
- Tact time reduced

The Benefits

Simplifies device configuration, reduces processes, reduces the cycle time and reduces costs.

Compatible with the FH series vision system and FQ2 series smart camera, it's a must for multiple products inspections.

Furthermore, the MX-Z2000H series, ...

Direct Finder Link Eliminates the need of a PLC

Using the MX-Z2000H series direct finder link, the laser marker and the vision system can be connected directly, without going through a PLC. This reduces the design effort even more.

There is no longer any need for the PLC control programming for each device.

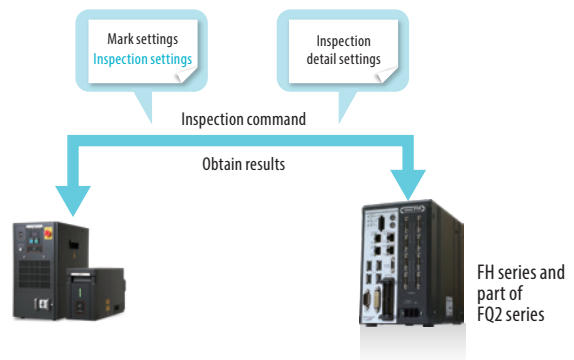

3

Display & Monitoring

A large screen simplifies marking monitoring and provides visibility of a larger area.

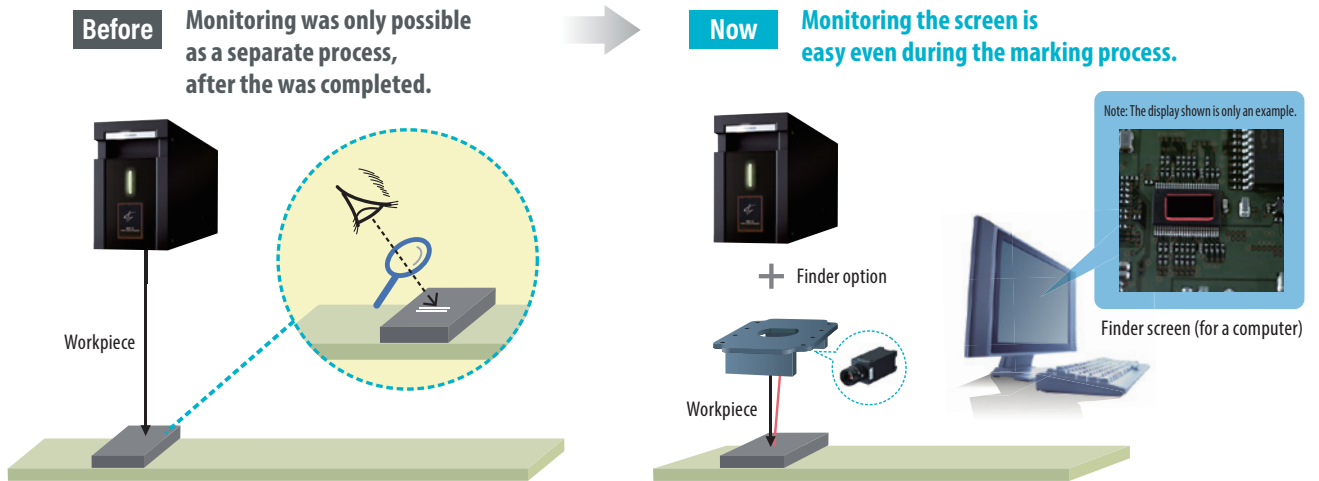

Note: The graphic shown is not an actual system application.

The Advantages

- Confirm the mark position easily on the monitor.
- Choose the lens and lighting that best fits for your application.

Choose the Right Lens for the Required Field of View

When Example using the FZ-S2M camera and FH vision controller

Using the MX-9151 camera attachment and different camera lenses, they will give the following perspective when viewing 15mm integrated chips:

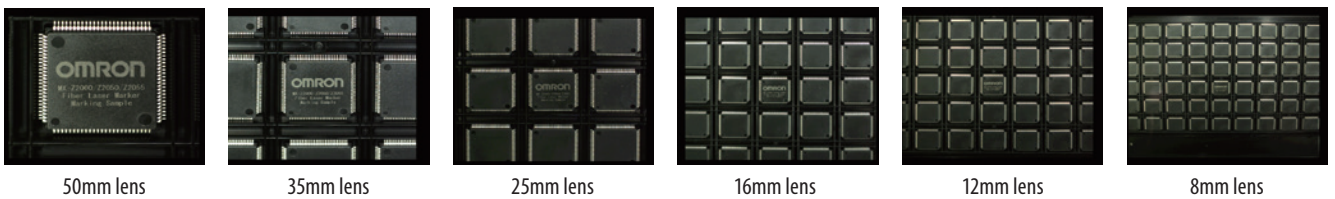

Choose the Most Suitable Lighting for Your Application



Choose the mounting position.



Adjust the angle with the mounting brackets.

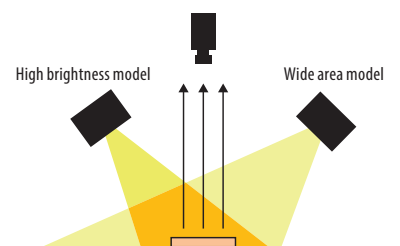

Using a high brightness bar light and a wide area model. (Diffusion plates are also available.)

Finder Option Device Configuration

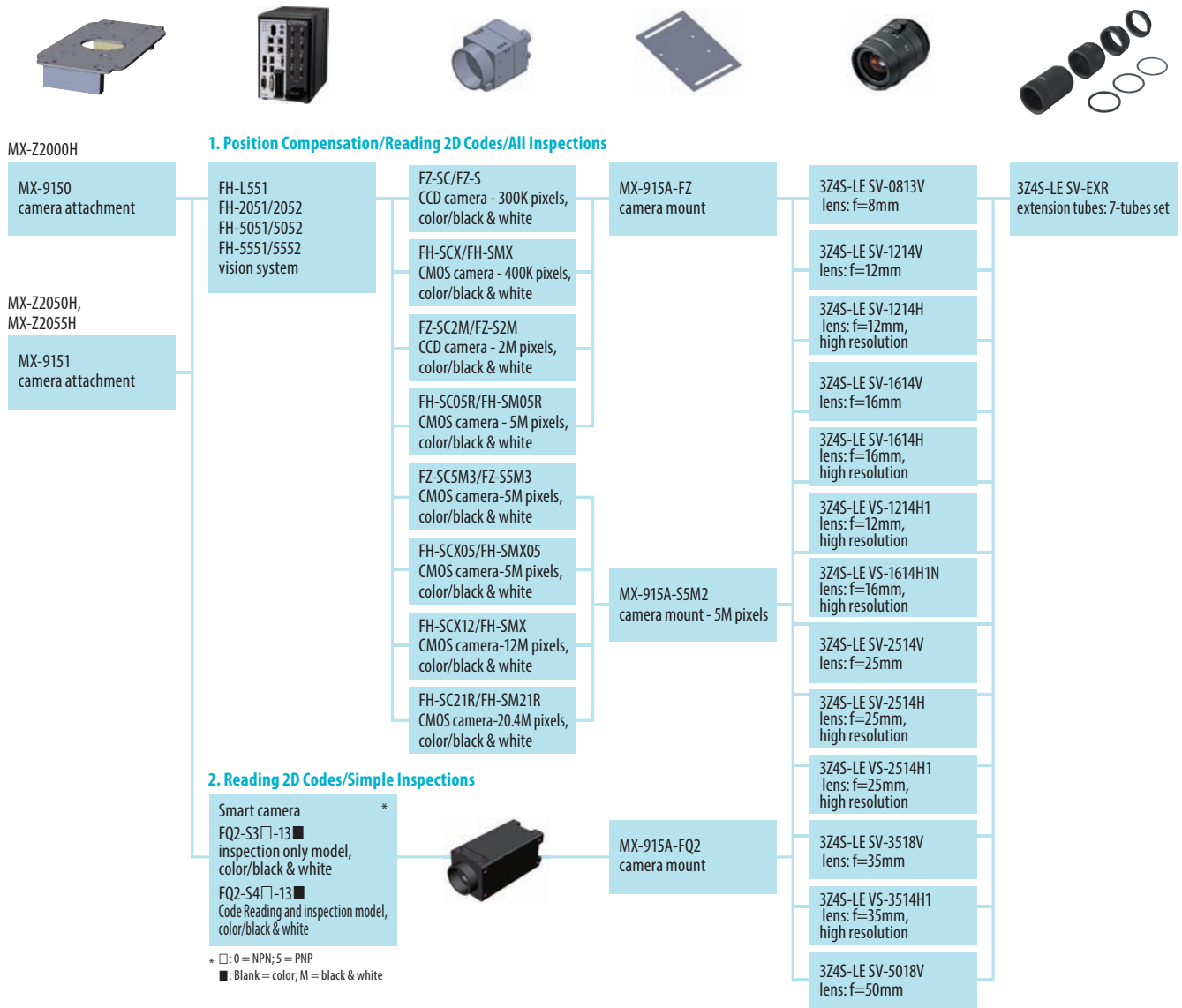

Camera Attachment Dimensions

MX-9150, MX-9151

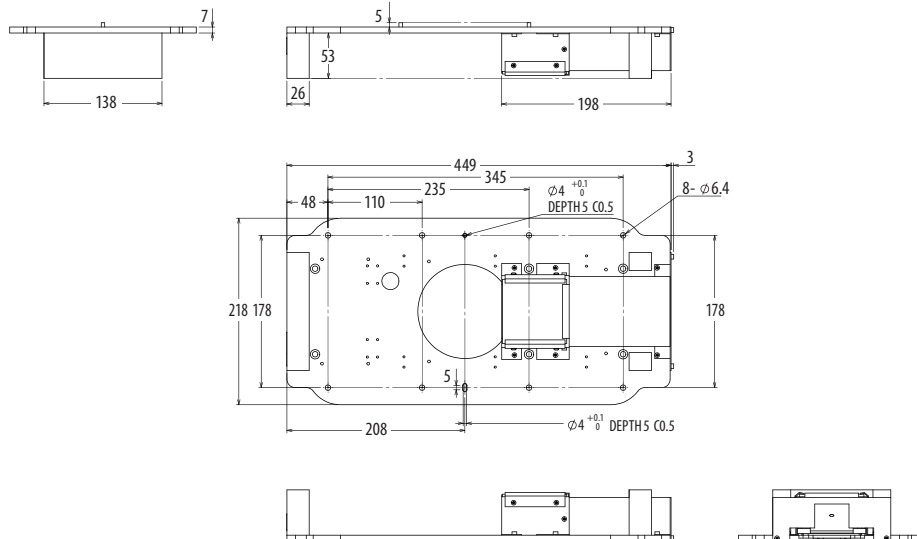

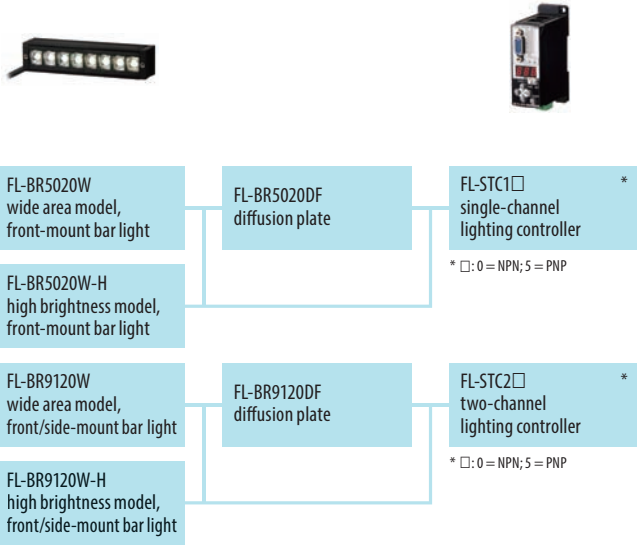

■ **Lens Selection**

When selecting a lens, follow the Lens Selection Criterion table below and the camera optical charts. Select the best camera and lens for your application, based on the optical table and your vision area needs. The extension tubes may also be needed. The optical charts, are included in the catalog for the camera being used.

■ **Lighting**

The FL-XBK1 mounting bracket is required to mount the lighting bar to the camera attachment. You may also need the FL-XC□: □ lighting extension cable (1m-25m), depending on the distance between the lighting bar and the lighting controller.

■ **Power Supply, Misc.**

A 24VDC power supply is required for the lighting bar and the vision system or smart camera. Select the appropriate power supply based on the power consumption of the devices. Your device configuration may also require a touch finder, LCD monitor, etc. Be sure to consider all needed devices when selecting the power supply, camera cables, Ethernet cables, and so on.

Refer to the appropriate product catalogs for details.

Lens Selection Criterion

(Distance between the Camera and the Workpiece)

Model	Camera Installation Distance*
MX-9150	Abt. 220mm
MX-9151	Abt. 270mm

*Remember to consider both the camera installation position and the length of the lens when calculating the distance between the camera and the workpiece.

Camera Attachment Specifications

Camera attachment	MX-9150			MX-9151		
	MX-Z2000H series			MX-Z2050H/MX-Z2055H series		
Compatible laser markers						
Compatible camera mounts	MX-915A-FQ2	MX-915A-FZ	MX-915A-S5M2	MX-915A-FQ2	MX-915A-FZ	MX-915A-S5M2
Compatible cameras (C-mount)*1	FQ2-S30-13 FQ2-S35-13 FQ2-S30-13M FQ2-S35-13M FQ2-S40-13 FQ2-S45-13 FQ2-S40-13M FQ2-S45-13M	FZ-SC FZ-S FZ-SC2M FZ-S2M FH-SC05R FH-SM05R FH-SCX FH-SMX	FZ-S5M3 FZ-SC5M3 FH-SCX05 FH-SMX05 FH-SCX12 FH-SMX12 FH-SC21R FH-SM21R	FQ2-S30-13 FQ2-S35-13 FQ2-S30-13M FQ2-S35-13M FQ2-S40-13 FQ2-S45-13 FQ2-S40-13M FQ2-S45-13M	FZ-SC FZ-S FZ-SC2M FZ-S2M FH-SC05R FH-SM05R FH-SCX FH-SMX	FZ-S5M3 FZ-SC5M3 FH-SCX05 FH-SMX05 FH-SCX12 FH-SMX12 FH-SC21R FH-SM21R
Compatible lighting*2	FL-BR5020W FL-BR5020W-H FL-BR9120W FL-BR9120W-H			FL-XBK1 mounting bracket FL-XC□ extension cable FL-BR5020DF diffusion plate FL-BR-9120DF diffusion plate		
Ambient operating temperature	0-40°C					
Ambient operating humidity	35-85%RH (no condensation)					
Ambient storage temperature	-10-60°C (no freezing)					
Ambient storage humidity	35-85%RH (no condensation)					
Dimensions	W218mm x H60mm x D449 mm (except protrusions)					
Weight	Abt. 2.5kg (camera attachment only)					

*1 The image output from the camera is a mirror image. Mirror image processing must be performed by the camera controller. The FQ2 cannot correct the mirror image, meaning that the mirror image will remain as is. The FH can correct the mirror image with the trapezoidal distortion correction and the reverse conversion heading. The image captured by the camera will show some distortions, such as being diagonally off or off the optical axis. The marked image you see on the screen may therefore look distorted or off-center.

*2 Provide a separate 24VDC power supply for the lighting. The camera image varies depending on the work piece. Check before you use the camera.

Terms and Conditions Agreement

Read and understand this catalog.

Please read and understand this catalog before purchasing the products. Please consult your OMRON representative if you have any questions or comments.

Warranties.

- (a) Exclusive Warranty. Omron's exclusive warranty is that the Products will be free from defects in materials and workmanship for a period of twelve months from the date of sale by Omron (or such other period expressed in writing by Omron). Omron disclaims all other warranties, express or implied.
- (b) Limitations. OMRON MAKES NO WARRANTY OR REPRESENTATION, EXPRESS OR IMPLIED, ABOUT NON-INFRINGEMENT, MERCHANTABILITY OR FITNESS FOR A PARTICULAR PURPOSE OF THE PRODUCTS. BUYER ACKNOWLEDGES THAT IT ALONE HAS DETERMINED THAT THE PRODUCTS WILL SUITABLY MEET THE REQUIREMENTS OF THEIR INTENDED USE.

Omron further disclaims all warranties and responsibility of any type for claims or expenses based on infringement by the Products or otherwise of any intellectual property right. (c) Buyer Remedy. Omron's sole obligation hereunder shall be, at Omron's election, to (i) replace (in the form originally shipped with Buyer responsible for labor charges for removal or replacement thereof) the non-complying Product, (ii) repair the non-complying Product, or (iii) repay or credit Buyer an amount equal to the purchase price of the non-complying Product; provided that in no event shall Omron be responsible for warranty, repair, indemnity or any other claims or expenses regarding the Products unless Omron's analysis confirms that the Products were properly handled, stored, installed and maintained and not subject to contamination, abuse, misuse or inappropriate modification. Return of any Products by Buyer must be approved in writing by Omron before shipment. Omron Companies shall not be liable for the suitability or unsuitability or the results from the use of Products in combination with any electrical or electronic components, circuits, system assemblies or any other materials or substances or environments. Any advice, recommendations or information given orally or in writing, are not to be construed as an amendment or addition to the above warranty.

See <http://www.omron.com/global/> or contact your Omron representative for published information.

Limitation on Liability; Etc.

OMRON COMPANIES SHALL NOT BE LIABLE FOR SPECIAL, INDIRECT, INCIDENTAL, OR CONSEQUENTIAL DAMAGES, LOSS OF PROFITS OR PRODUCTION OR COMMERCIAL LOSS IN ANY WAY CONNECTED WITH THE PRODUCTS, WHETHER SUCH CLAIM IS BASED IN CONTRACT, WARRANTY, NEGLIGENCE OR STRICT LIABILITY.

Further, in no event shall liability of Omron Companies exceed the individual price of the Product on which liability is asserted.

Suitability of Use.

Omron Companies shall not be responsible for conformity with any standards, codes or regulations which apply to the combination of the Product in the Buyer's application or use of the Product. At Buyer's request, Omron will provide applicable third party certification documents identifying ratings and limitations of use which apply to the Product. This information by itself is not sufficient for a complete determination of the suitability of the Product in combination with the end product, machine, system, or other application or use. Buyer shall be solely responsible for determining appropriateness of the particular Product with respect to Buyer's application, product or system. Buyer shall take application responsibility in all cases.

NEVER USE THE PRODUCT FOR AN APPLICATION INVOLVING SERIOUS RISK TO LIFE OR PROPERTY OR IN LARGE QUANTITIES WITHOUT ENSURING THAT THE SYSTEM AS A WHOLE HAS BEEN DESIGNED TO ADDRESS THE RISKS, AND THAT THE OMRON PRODUCT(S) IS PROPERLY RATED AND INSTALLED FOR THE INTENDED USE WITHIN THE OVERALL EQUIPMENT OR SYSTEM.

Programmable Products.

Omron Companies shall not be responsible for the user's programming of a programmable Product, or any consequence thereof.

Performance Data.

Data presented in Omron Company websites, catalogs and other materials is provided as a guide for the user in determining suitability and does not constitute a warranty. It may represent the result of Omron's test conditions, and the user must correlate it to actual application requirements. Actual performance is subject to the Omron's Warranty and Limitations of Liability.

Change in Specifications.

Product specifications and accessories may be changed at any time based on improvements and other reasons. It is our practice to change part numbers when published ratings or features are changed, or when significant construction changes are made. However, some specifications of the Product may be changed without any notice. When in doubt, special part numbers may be assigned to fix or establish key specifications for your application. Please consult with your Omron's representative at any time to confirm actual specifications of purchased Product.

Errors and Omissions.

Information presented by Omron Companies has been checked and is believed to be accurate; however, no responsibility is assumed for clerical, typographical or proofreading errors or omissions.

Note: Do not use this document to operate the Unit.

OMRON Corporation Industrial Automation Company

Kyoto, JAPAN

Contact : www.ia.omron.com

Regional Headquarters

OMRON EUROPE B.V.

Wegalaan 67-69, 2132 JD Hoofddorp
The Netherlands

Tel: (31) 2356-81-300 Fax: (31) 2356-81-388

OMRON ASIA PACIFIC PTE. LTD.

438B Alexandra Road, #08-01/02 Alexandra
Technopark, Singapore 119968

Tel: (65) 6835-3011 Fax: (65) 6835-3011

OMRON ELECTRONICS LLC

2895 Greenspoint Parkway, Suite 200
Hoffman Estates, IL 60169 U.S.A.

Tel: (1) 847-843-7900 Fax: (1) 847-843-7787

OMRON (CHINA) CO., LTD.

Room 2211, Bank of China Tower,
200 Yin Cheng Zhong Road,
PuDong New Area, Shanghai, 200120, China

Tel: (86) 21-6023-0333 Fax: (86) 21-5037-2388

Authorized Distributor:

©OMRON Corporation 2016-2024 All Rights Reserved.
In the interest of product improvement,
specifications are subject to change without notice.

CSM_2_3

Cat. No. Q255-E1-06 0624 (0916)