

Improve productivity and cost reduction in harsh welding environments

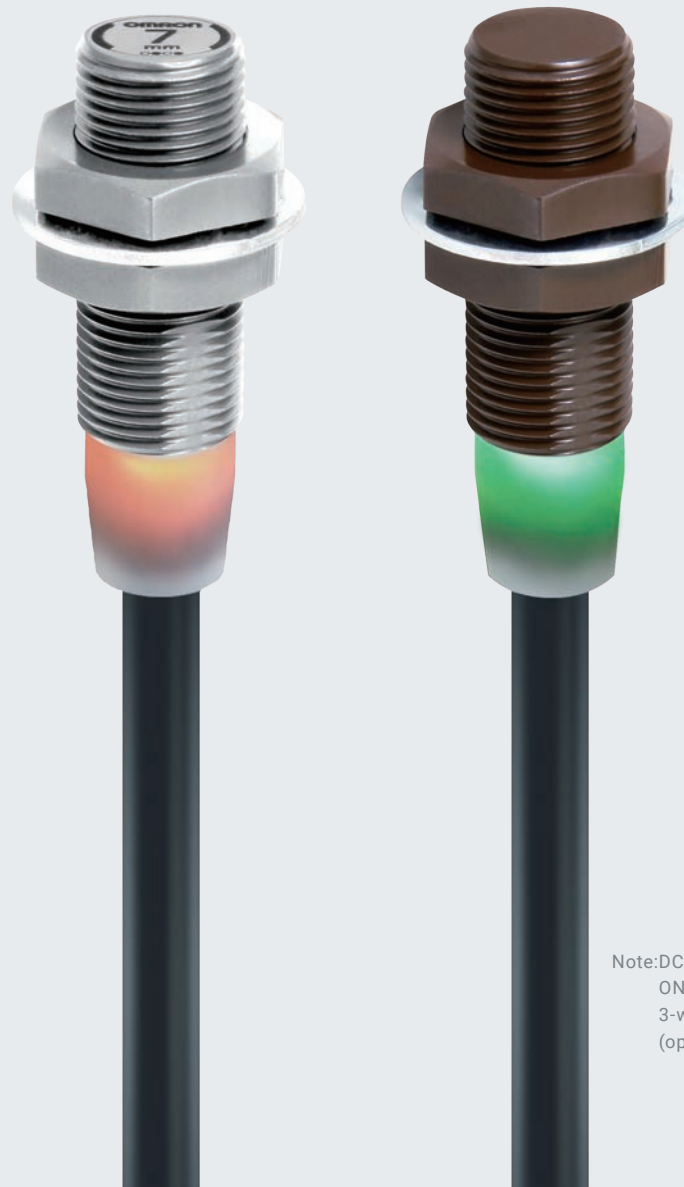

E2EW Series boosts productivity while cutting equipment costs in welding processes

Sophisticated and complex production equipment and a severe shortage of skilled workers increase the need to easily design equipment and maintain and improve equipment uptime without relying on experience and skills. Omron's E2EW Series offers stable detection and excellent environmental resistance. This improves the efficiency of design, commissioning, operation, and maintenance of welding lines, contributing to increasing productivity and reducing equipment costs.



Note: DC 2-wire model: green indicator ON (setting distance range), DC 3-wire model: orange indicator ON (operating)

Issue of productivity

Improve productivity by evolving equipment to respond to changes in manufacturing

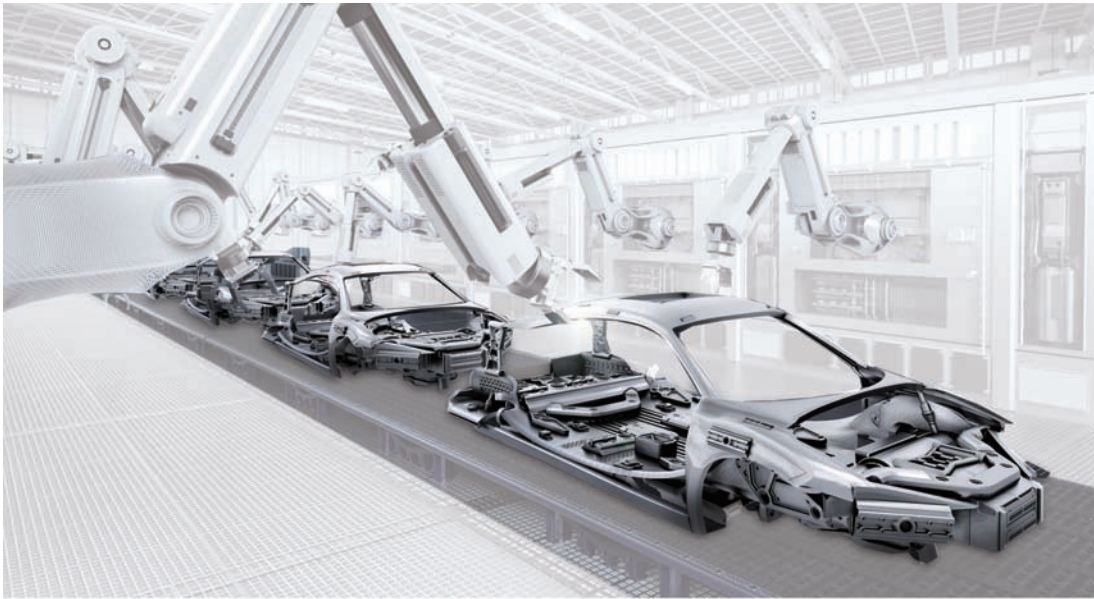

For full metal body proximity sensor users
Further increase design efficiency and
equipment uptime

> Page 4

Issue of equipment costs

Further reduce equipment costs
other than by reducing parts
procurement costs

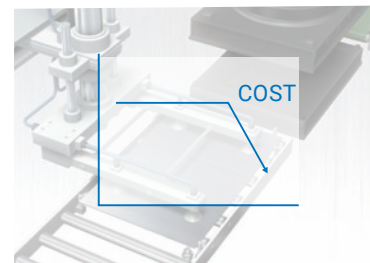

For resin head proximity sensor users
Reduce total equipment costs

> Page 6

Address the issue of productivity

For full metal body proximity sensor users

Further increase design efficiency and equipment uptime

	DC 2-wire	DC 3-wire
PREMIUM Model	—	●
BASIC Model	●	●

Reduce maintenance and replacement frequency even in harsh environments

E2EW spatter-resistant models are coated with fluororesin to prevent spatter from sticking, reducing maintenance frequency. Another technology to prevent coating abrasion reduces sensor replacement frequency.



Technologies > Page 8

* 1. This value assumes that the sensor operates 10 hours a day in an arc welding environment and is cleaned once a month (12 times a year). If our previous model (E2EF-Q) needs to be replaced once every 3 times it is cleaned, the E2EW-Q Proximity Sensor needs to be replaced once every 180 times it is cleaned. This means that there is no need to replace the E2EW-Q Proximity Sensor for 10 or more years.

	DC 2-wire	DC 3-wire
PREMIUM Model	—	●
BASIC Model	—	—

Less unexpected downtime due to false detections

Stable long distance detection reduces unexpected line stoppages previously caused by false detections due to vibrating workpieces.

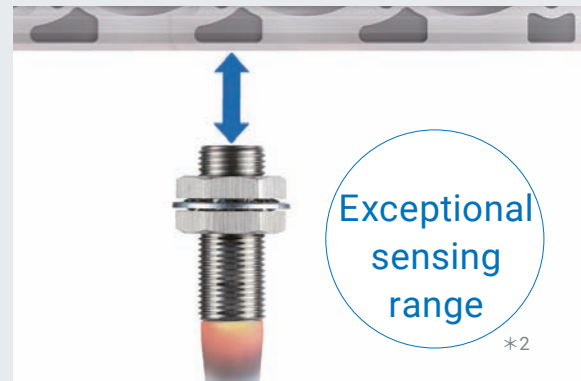

Technologies > Page 9

Stable detection and common design for both iron and aluminum

The E2EW Proximity Sensor offers the same sensing distance for both iron and aluminum, enabling common design. Its exceptional sensing range mitigates false detections, thereby minimizing unexpected downtime.



Technologies > Page 10

Stable operation by identifying changes in equipment condition

In addition to presence detection, invisible temperature changes of equipment can be identified, which helps detect equipment abnormalities.



Technologies > Page 11

* 2. Based on Omron investigation in September 2021. M12 quadruple distance models.

Address the issue of equipment costs

For resin head proximity sensor users

Reduce total equipment costs

The E2EW DC 2-wire BASIC Model can significantly reduce total costs because its robust and environmental resistant design eliminates hardware and labor costs associated with replacing sensors and opportunity loss caused by line stoppages due to sensor failures *7.

Reduction in total costs *7 for 10 years *1

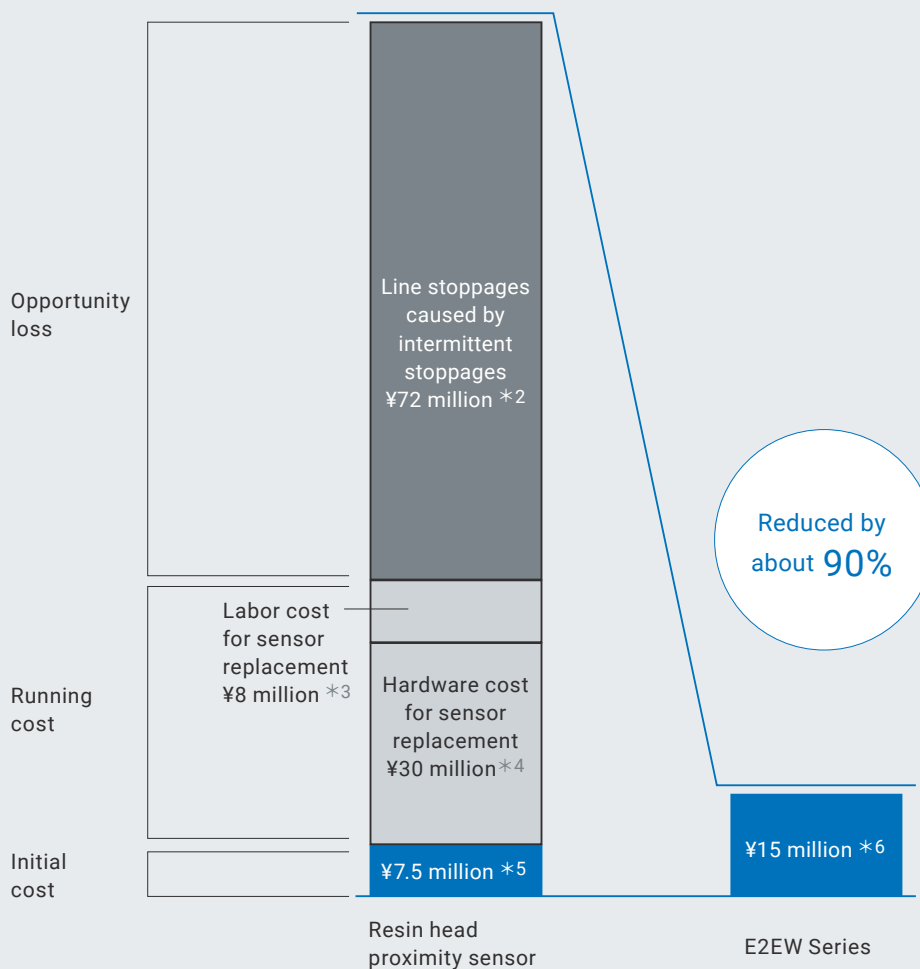

Note: The graphs are for illustration purposes only.

*1. It is defined that an automotive manufacturer makes a model changeover every 10 years. *2. The time required for replacement due to unexpected stoppages is estimated to be 1 hour per month, and opportunity loss per minute is estimated to be ¥10,000. *3. Hourly labor cost for replacement ¥2,000 x 1,000 sensors x replacement 4 times (for 10 years). *4. List price of E2E NEXT (DC 2-wire Standard Model, M12) ¥7,500 x 1,000 sensors x replacement 4 times (for 10 years). *5. List price of E2E NEXT (DC 2-wire Standard Model, M12) ¥7,500 x 1,000 sensors. *6. List price of E2EW (DC 2-wire Spatter-resistant Single distance Model, M12) ¥15,000 x 1,000 sensors. *7. Estimated from 1,000 sensors (20 sensors on a jig x 50 jigs) in a welding line for 250,000 cars. There is no need to replace the E2EW Series for 10 years from the viewpoints of shock resistance (*Y) and spatter resistance (*Z). (*Y) This value assumes that the equipment operates 10 hours a day and workpieces mounted to welding jigs hit a proximity sensor 100 times a day with the force equivalent to the force used in our continuous impact tests. Omron's sensor was not penetrated even after our continuous impact test consisting of 200,000 repetitions, which means that there is no need to replace it for 10 or more years. (*Z) This value assumes that the sensor operates 10 hours a day in an arc welding environment and is cleaned once a month (12 times a year). If our previous model (E2EF-Q) needs to be replaced once every 3 times it is cleaned, the E2EW-Q Proximity Sensor needs to be replaced once every 180 times it is cleaned. This means that there is no need to replace the E2EW-Q Proximity Sensor for 10 or more years.

	DC 2-wire	DC 3-wire
PREMIUM Model	—	●
BASIC Model	●	●

Reduce unexpected downtime and replacement frequency

The metal head resists friction and collision with workpieces and metal cleaning brushes, reducing unexpected downtime and replacement frequency due to failure caused by wear and collision compared to previous resin heads.



Technologies > Page 12

Reduce maintenance and replacement frequency even in harsh environments

The spatter and abrasion resistant fluoro-resin coating technology enables long-lasting spatter resistance. The maintenance and replacement frequency is much less than that of resin head proximity sensors without fluoro-resin coating.



Technologies > Page 8

*8. This value assumes that the sensor operates 10 hours a day in an arc welding environment and is cleaned once a month (12 times a year). If our previous model (E2EF-Q) needs to be replaced once every 3 times it is cleaned, the E2EW-Q Proximity Sensor needs to be replaced once every 180 times it is cleaned. This means that there is no need to replace the E2EW-Q Proximity Sensor for 10 or more years.

Fluoro-resin coated resin head models are also available.



E2EQ NEXT
(Triple distance model)



E2EQ
(Standard model)

	DC 2-wire	DC 3-wire
PREMIUM Model	—	●
BASIC Model	●	●

Long-lasting spatter resistance without need for replacement for 10 years*1

The spatter and abrasion resistant coating ensures long-lasting resistance.

Spatter resistance reduces maintenance frequency

The spatter resistant fluororesin coating reduces maintenance frequency even in environments with welding spatter.

Previous model *2

Spatter covering a wide area causes malfunction in about one month.

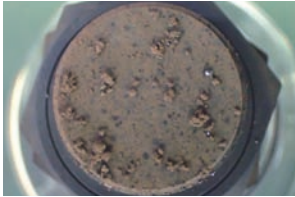

E2EW-Q

Fluororesin coating prevents spatter from sticking.



Cleaning frequency reduced to half*3

Abrasion resistance reduces sensor replacement frequency

The abrasion resistant fluororesin coating provides long-lasting spatter resistance against cleaning, allowing for less frequent sensor replacement.

Previous model *2

40x zoom with a microscope



After use*4



Coating comes off quickly even with a spatter-resistant model.

E2EW-Q

40x zoom with a microscope



After use*4



Coating lasts long. 1/60 replacement frequency*5

Technologies for increasing spatter resistance **Patent Pending** *6

Key points for increasing spatter resistance: 1. Prevent spatter from sticking
2. Prevent the coating from being worn away during spatter cleanup
Omron pursued two technologies shown below to deliver long-lasting resistance.

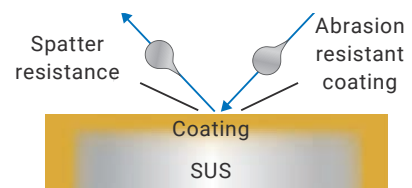

Technology to prevent spatter from sticking

The coating film formation technology to apply a highly hydrophobic coating reduces the amount of spatter sticking to the surface to approximately half of previous models.

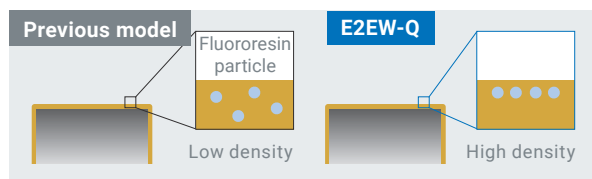

Technology to prevent coating from wearing off

The unique coating film formation technology coupled with a specially treated base surface greatly reduces abrasion, to approximately 1/60 of previous models.

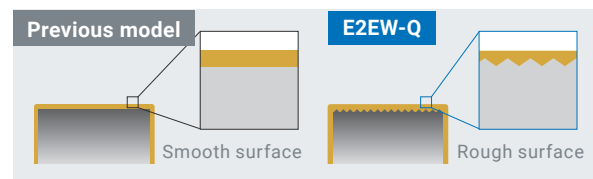

*1. This value assumes that the sensor operates 10 hours a day in an arc welding environment and is cleaned once a month (12 times a year). If our previous model (E2EF-Q) needs to be replaced once every 3 times it is cleaned, the E2EW-Q Proximity Sensor needs to be replaced once every 180 times it is cleaned. This means that there is no need to replace the E2EW-Q Proximity Sensor for 10 or more years. *2. Our previous model E2EF-Q. *3. Comparison with our previous model E2EF-Q. Based on Omron investigation in September 2021. *4. The surface is brushed 10 times vertically and horizontally with a metal brush for each cleaning. Cleaning is repeated 6 times. *5. Comparison with our previous model E2EF-Q. Based on Omron investigation in September 2021. *6. "Patent Pending" means that we applied for a patent in Japan, and "Patented" means that we obtained a patent in Japan. (As of September 2021)

	DC 2-wire	DC 3-wire
PREMIUM Model	—	●
BASIC Model	—	—

Exceptional^{*1} sensing range

Previous full metal body proximity sensors with a shorter sensing distance than resin head proximity sensors cannot detect stably if workpieces are moved from their intended positions. E2EW PREMIUM Models with a longer sensing distance reduce false detections, minimizing unexpected downtime. Furthermore, when equipment is set up or a sensor is replaced, the sensor can be quickly and easily installed without strict adjustment of its installation distance. This maintains and further improves equipment uptime.

Approximately double the sensing distance of previous model^{*1} (quadruple distance model)

Exceptional sensing range ^{*2}

Sensing distance comparison

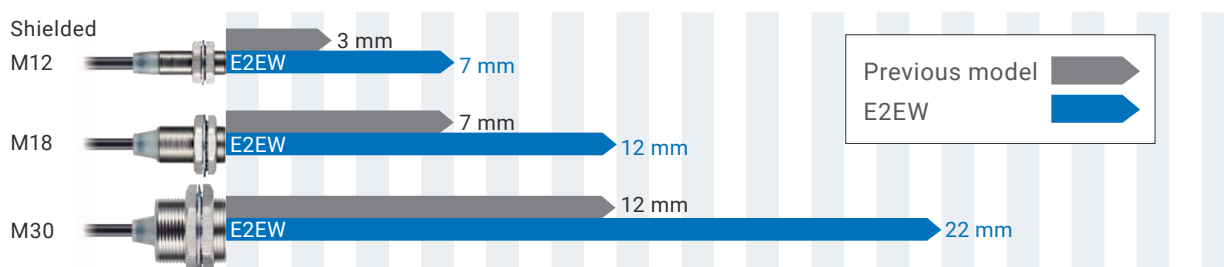

*1. Comparison with our previous model E2EF. *2. Based on Omron investigation in September 2021.

More efficient sensor installation design

E2EW Proximity Sensors with the exceptional sensing range provide accurate detection from a certain distance, which is impossible with previous models. They can be installed with sufficient space to reduce sensor damage.

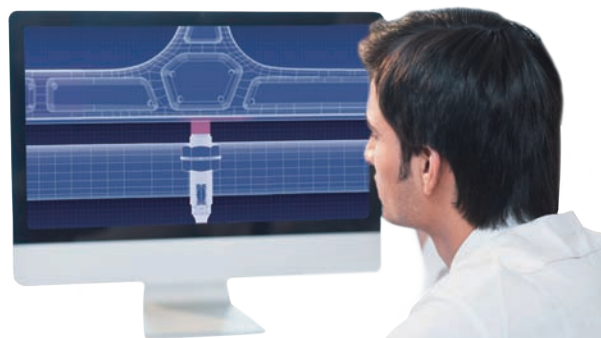

Design example

(Size: M12)

When prioritizing sensing distance

Use a quadruple distance model with an exceptional sensing range (sensing distance: 7 mm). The sensing surface of the proximity sensor must stick out from the plate.

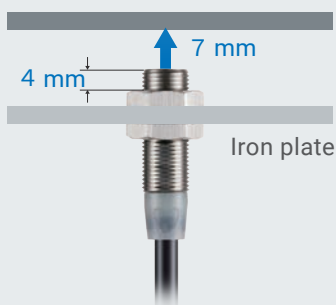

When installing flush with the surface

Use a triple distance model (sensing distance: 6 mm). When the proximity sensor is embedded in iron metal, its sensing surface does not need to protrude from the surface.

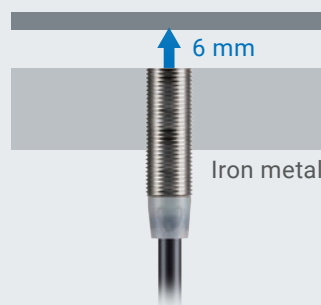

Note: Refer to page 35 for detail.

	DC 2-wire	DC 3-wire
PREMIUM Model	—	●
BASIC Model	—	—

Equal sensing distances for iron and aluminum

A unique Omron technology provides equal sensing distances for both iron and aluminum. Mixed-metal production lines with less unexpected downtime can be designed.

Minimizing unexpected downtime maximizes uptime

E2EW Proximity Sensors provide equally long distance detection for iron and aluminum, reducing false detections even if workpieces are moved from their intended positions. Furthermore, when equipment is set up or a sensor is replaced, the sensor can be quickly and easily installed without strict adjustment of its installation distance.

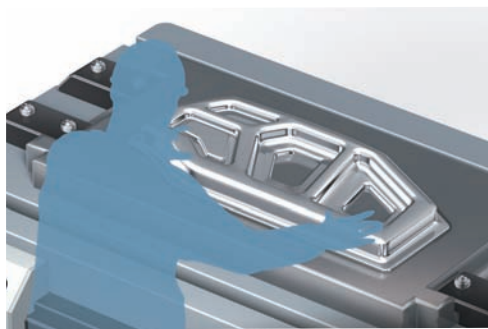

Checking correct positions of doors

Previous model

A workpiece that is out of position would cause false detections, leading to equipment stoppages.

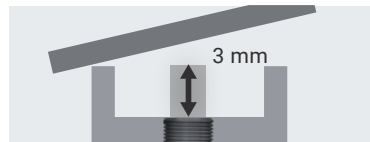

False detection

E2EW

Long-distance detection means improved detection margins, enabling stable detection even when a workpiece is out of position.

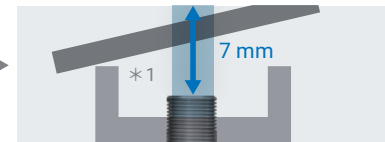

Stable detection

*1. Triple distance models that can be installed flush with the surface are also available. Refer to page 9 for details.

Unified design reduces design work

Unlike previous sensors which need to be changed for different sensing distances, E2EW Proximity Sensors with the same sensing distance for both iron and aluminum eliminate the need to change sensors in order to detect positions in mixed production lines containing both metal components. This enables standardization of production equipment and mechanical drawings.

Previous model

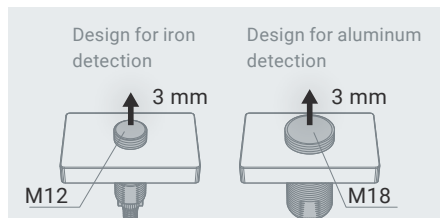

Different designs are required for different size sensors.

E2EW

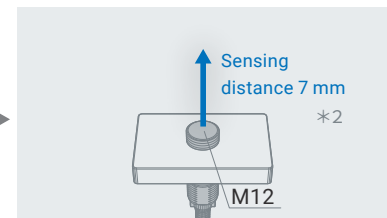

Design can be standardized on a single sensor.

*2. Quadruple distance models.

A unique Omron technology provides equally long sensing distances for both iron and aluminum

The problem of previous full metal body proximity sensors was the short sensing distance. E2EW Proximity Sensors are equipped with a unique technology for suppressing noise influence as well as the PRD*3 technology. Together they reduce the influence of noise, extending the sensing distance. Furthermore, equally long distance detection for iron and aluminum is possible by adjusting the timing and time to detect current changes of sensing objects.

Technology for suppressing noise influence **Patent Pending** *4

Random timing of pulsed current reduces the periodic noise effect on the detection signals.

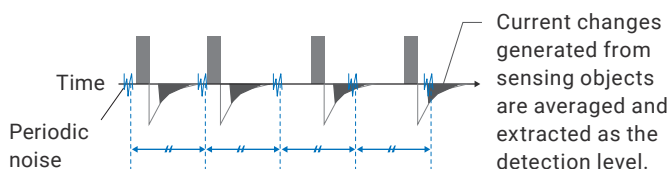

Long sensing distances for both iron and aluminum

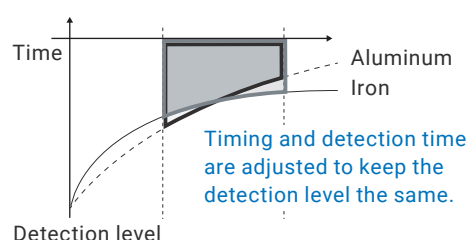

*3. PRD (Pulse Response Detection) is a technology to detect current changes of sensing objects when pulsed currents are applied to coils.

*4. "Patent Pending" means that we applied for a patent in Japan, and "Patented" means that we obtained a patent in Japan.

(As of September 2021)

	DC 2-wire	DC 3-wire
PREMIUM Model	—	●
BASIC Model	—	—

Detection level and temperature visualization with IO-Link

Daily changes in equipment conditions can be monitored via IO-Link, which helps you reduce tuning time during the commissioning phase and stabilize equipment operation during the mass production phase.

Identify changes in equipment by visualizing detection level

A real-time view of how the proximity sensors are detecting objects provides understanding of everyday changes in equipment conditions that may not be visible to the naked eye.

Application example Maintenance management based on spatter accumulation

Weld spatter can cause proximity sensors to malfunction. Monitoring detection level changes can allow for timely maintenance.

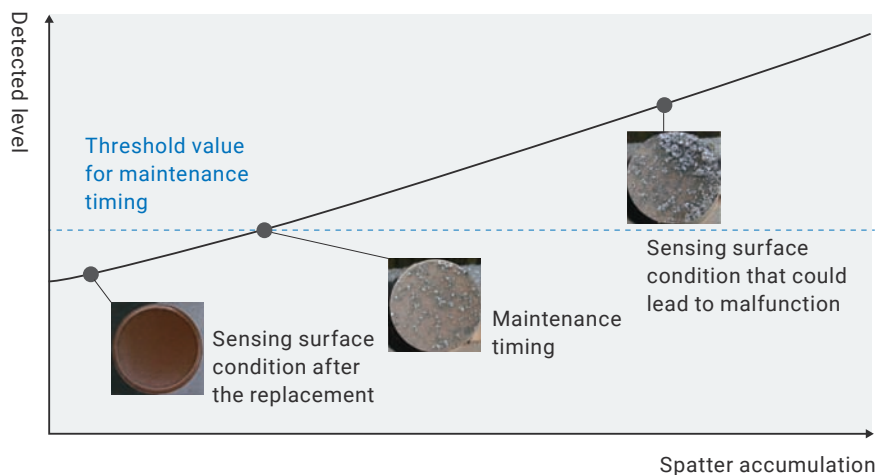

Detect equipment abnormalities by visualizing temperature

Temperature changes in tough environments are visualized in real time, helping detection of equipment abnormalities.

Application example Identification of temperature changes during welding

Temperature changes can be monitored via the proximity sensors installed in multiple positions to locate abnormal locations.

Proximity sensor temperature changes during welding cycles

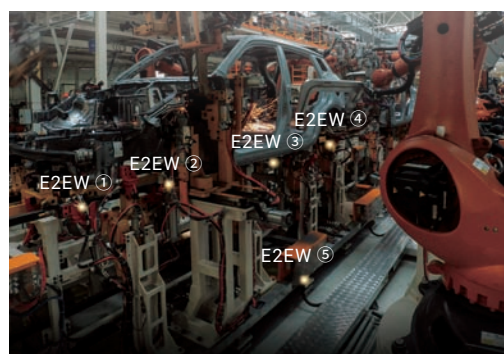
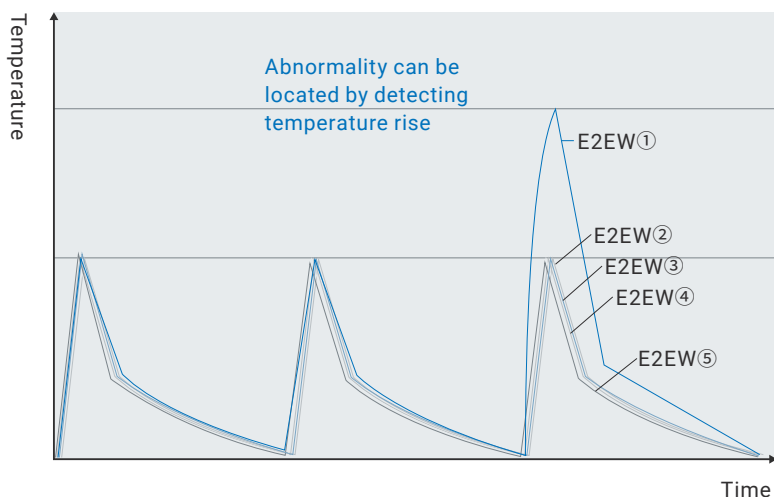

	DC 2-wire	DC 3-wire
PREMIUM Model	—	●
BASIC Model	●	●

Durable full metal body

The full metal housing is robust enough to use in production sites where the sensor often collides with workpieces, reducing replacement frequency.

Reduce replacement of proximity sensor due to sensing surface damage

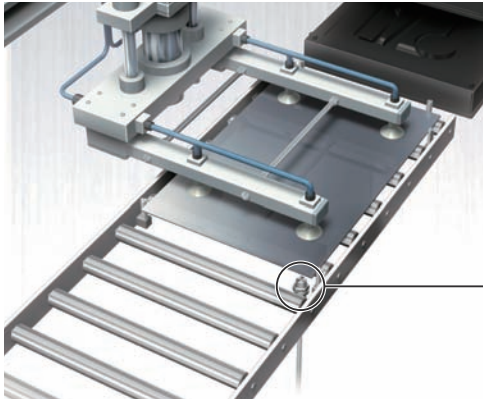

Position detection of iron plates

E2E (resin head)

Friction and collision with workpieces cause the sensing surface (head) to wear out, eventually leading to insulation breakdown.



Broken by collision

E2EW (metal head)

The thick metal head structure eliminates abrasion factors to deliver insulation breakdown resistance.



Resistant to collision

Thick metal head structure

Resistant to friction with workpieces and metal cleaning brushes

In wear resistance tests using stainless-steel brushes rotating at 130 rpm, insulation breakdown occurred in 50 minutes for resin heads, while no insulation breakdown occurred even after 400 minutes for metal heads.

Note: The tests were performed on E2EW M18 quadruple distance models with 0.4 mm sensing surface thickness.



Brush test

Resin head

E2E-X7D1



Initial state



After 50 minutes

Insulation
breakdown in
50 minutes

Full metal body

E2EW-X12□18



Initial state



After 50 minutes



After 400 minutes

No
insulation
breakdown
after 400
minutes

Resistant to collision with workpieces



Continuous impact test

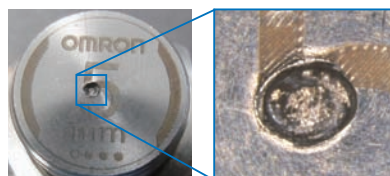

Continuous impact test results showed that the sensing surface was not penetrated even after impact was repeated 200,000 times. No insulation breakdown occurred.

Note: Sensing surface thickness varies for different models. Refer to the datasheet for details.

	DC 2-wire	DC 3-wire
PREMIUM Model	—	●
BASIC Model	●	●

Excellent usability

360° visible indicator for easy identification of detection status

The high-brightness LED indicator provides 360° visibility no matter where the sensor is fixed, allowing for speedy installation regardless of sensor orientation and easy check of detection status during operation.



Short body to fit in narrow spaces

The body that is up to 35% shorter than the previous models facilitates installation during commissioning and maintenance.

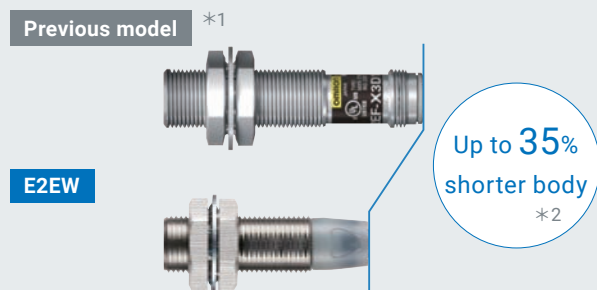

*1. E2EF. *2. M30.

Laser printed information to prevent replacement errors

Laser printed information (sensing distance on the sensor head*3 and model number on the cable) can withstand long-term use and be seen clearly, reducing errors during sensor replacement.

*3. Models without spatter-resistant coating only.

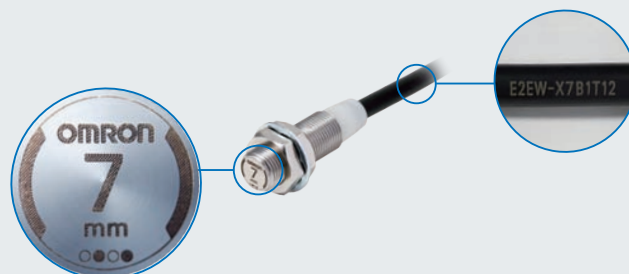

Simple inventory by standardizing on a single sensor

Inventory management can be streamlined by standardizing on a single sensor for iron and aluminum detection that previously required four sensors (e.g., E2EW Proximity Sensor 2-output (NO+NC) model instead of M12 NO and NC models and M18 NO and NC models). This also saves a great deal of storage space.

Note: DC 3-wire PREMIUM Models only.

Previous model

Use four models according to the purpose

E2EW

Standardize on a single model

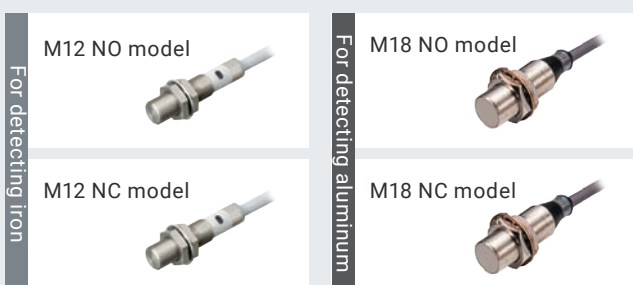

Detects both iron and aluminum
Equipped with NO and NC outputs
M12 2-output (NO+NC) model



Functions and Specifications

Main functions and specifications			DC 2-wire						
			Metal head				Fluororesin head		
			E2EW		E2EF	E2FM	E2EQ NEXT		E2EQ
			BASIC Model				PREMIUM Model	BASIC Model	
			Double distance model	Single distance model	Triple distance model	Double distance model			
Detection performance	Sensing distance * 1	M8	—	—	2 mm	1.5 mm	3 mm	—	—
		M12	3 mm	2 mm	3 mm	2 mm	7 mm	4 mm	3 mm
		M18	7 mm	5 mm	7 mm	5 mm	11 mm	8 mm	7 mm
		M30	12 mm	10 mm	12 mm	10 mm	20 mm	15 mm	10 mm
	Detection of mixed materials	Equal sensing for iron and aluminum	—	—	—	—	—	—	—
	Installation	Flush with surface	●	●	●	●	—	—	●
Flush with surface using nut		●	●	●	●	●	●	●	
Environmental resistance	Spatter resistance	Long-lasting special fluororesin coating	●*2	●*2	—	—	—	—	—
		Standard fluororesin coating	—	—	●*2	—	●	●	●
Industrial IoT enabled	Detection level and temp. visualization with IO-Link		—	—	—	—	—	—	—
Usability	360° visible indicator		● (Green)	● (Green)	—	—	● (Green)	● (Green)	—
	Laser printed model number		●	●	—	—	●	●	—
	2-output (NO+NC) model		—	—	—	—	—	—	—
Datasheet			P17 ~		P39 ~		P45 ~		P64 ~

DC 3-wire							
Metal head				Fluororesin head			
E2EW				E2FM	E2EQ NEXT		
PREMIUM Model		BASIC Model			PREMIUM Model	BASIC Model	
Quadruple distance model	Triple distance model	Double distance model	Single distance model			Triple distance model	Double distance model
—	—	—	—	1.5 mm	3 mm	2 mm	1.5 mm
7 mm	6 mm	3 mm	2 mm	2 mm	6 mm	4 mm	2 mm
12 mm	10 mm	7 mm	5 mm	5 mm	12 mm	8 mm	5 mm
22 mm	20 mm	12 mm	10 mm	10 mm	22 mm	15 mm	10 mm
●	●	—	—	—	—	—	—
—	●	●	●	●	—	—	●
—	● (M30 only)	●	●	●	●	●	●
●*2	●*2	●*2	●*2	—	—	—	—
—	—	—	—	—	●	●	●
●	●	—	—	—	●	●	●
● (Orange)	● (Orange)	● (Orange)	● (Orange)	—	● (Orange)	● (Orange)	● (Orange)
●	●	●	●	—	●	●	●
●*3	●*3	●*3	●*3	—	●*3	●*3	●*3
P17 ~				P39 ~	P45 ~		

*1. Models displayed in gray are not described in this catalog. *2. Spatter-resistant models only. *3. 2-output (NO+NC) models only.

Welding Proximity Sensor E2EW Series

DC 2-wire/DC 3-wire

Stable detection in lines containing both aluminum and iron

- Equivalent sensing distances for both iron and aluminum *1
- Enables common design for lines with both iron and aluminum *1
- The exceptional sensing range *2, which means fewer false detections and thereby fewer unexpected stoppages.
- OMRON's unique fluororesin coating technologies enable long-lasting spatter resistance *4, eliminates the need to replace for 10 years *3.
- Durable full metal body to reduce unexpected stoppages
- 2-output (NO+NC) models and models with IO-Link *1 are also available.
- Laser printed information (sensing distance on the sensor head, model on the cable, and model on the metal part of the connector model) can be reducing errors during sensor replacement. *5
- Equipped with a function, which effectively cancels pulse noise of current magnetic field. *1
- UL certification (UL60947-5-2) and CSA certification (CSA C22.2 UL60947-5-2-14)

*1. PREMIUM Models only.

*2. Based on September 2021 OMRON investigation.

*3. This value assumes that the sensor operates 10 hours a day in an arc welding environment and is cleaned once a month (12 times a year). If our previous model (E2EF-Q) needs to be replaced once every 3 times it is cleaned, the E2EW-Q Proximity Sensor needs to be replaced once every 180 times it is cleaned. This means that there is no need to replace the E2EW-Q Proximity Sensor for 10 or more years.

*4. Models with spatter-resistant coating only.

*5. Models without spatter-resistant coating only.



For the most recent information on models that have been certified for safety standards, refer to your OMRON website.



Be sure to read *Safety Precautions* on page 34.

E2EW Series Model Number Legend

E2EW - (1) X (2) (3) (4) (5) (6) - (7) - (8) (9)

No.	Type	Code	Meaning	Remarks
(1)	Case	Blank	Without spatter-resistant coating	
		Q	With spatter-resistant coating	
(2)	Sensing distance	Number	Sensing distance (Unit: mm)	
(3)	Output configuration	B	DC 3-wire PNP open collector	Whether the D model has polarity is defined by number (8).
		C	DC 3-wire NPN open collector	
		D	DC 2-wire polarity/no polarity	
(4)	Operation mode	1	Normally open (NO)	
		2	Normally closed (NC)	
		3	Normally open, Normally closed (NO+NC)	
(5)	IO-Link baud rate	Blank	Non IO-Link compliant	
		D	COM2 (38.4kbps)	
		T	COM3 (230.4kbps)	
(6)	Size	12	M12	
		18	M18	
		30	M30	
(7)	Connection method	Blank	Pre-wired Models	
		M1	M12 Connector Models	
		M1TGJ	M12 Pre-wired Smartclick Connector Models DC 2-wire	
		M1TJ	M12 Pre-wired Smartclick Connector Models DC 3-wire	
(8)	DC 2-wire polarity	Blank	Polarity	
		T	No polarity	
(9)	Cable length	Number M	Cable length	

Note: The purpose of this model number legend is to provide understanding of the meaning of specifications from the model number.

E2EW Series

Ordering Information

BASIC Model

E2EW Series (Double distance model)

DC 2-wire [Refer to Ratings and Specifications on page 24, Dimensions on page 37.]

Size (Sensing distance)	Connection method	Polarity	Model	
			Operation mode: NO	Operation mode: NC
M12 (3 mm)	Pre-wired (2 m) *1	Yes	E2EW-X3D112 2M	E2EW-X3D212 2M
	M12 Pre-wired Smartclick Connector (0.3 m)	Yes	E2EW-X3D112-M1TGJ 0.3M	---
		No	E2EW-X3D112-M1TGJ-T 0.3M	---
M18 (7 mm)	Pre-wired (2 m) *1	Yes	E2EW-X7D118 2M	E2EW-X7D218 2M
	M12 Pre-wired Smartclick Connector (0.3 m)	Yes	E2EW-X7D118-M1TGJ 0.3M	---
		No	E2EW-X7D118-M1TGJ-T 0.3M	---
M30 (12 mm)	Pre-wired (2 m) *1	Yes	E2EW-X12D130 2M	E2EW-X12D230 2M
	M12 Pre-wired Smartclick Connector (0.3 m)	Yes	E2EW-X12D130-M1TGJ 0.3M	---
		No	E2EW-X12D130-M1TGJ-T 0.3M	---

BASIC Model

E2EW Series (Single distance model)

DC 2-wire [Refer to Ratings and Specifications on page 24, Dimensions on page 37.]

Size (Sensing distance)	Connection method	Polarity	Model	
			Operation mode: NO	Operation mode: NC
M12 (2 mm)	Pre-wired (2 m) *1	Yes	E2EW-X2D112 2M	E2EW-X2D212 2M
	M12 Pre-wired Smartclick Connector (0.3 m)	Yes	E2EW-X2D112-M1TGJ 0.3M	---
		No	E2EW-X2D112-M1TGJ-T 0.3M	---
M18 (5 mm)	Pre-wired (2 m) *1	Yes	E2EW-X5D118 2M	E2EW-X5D218 2M
	M12 Pre-wired Smartclick Connector (0.3 m)	Yes	E2EW-X5D118-M1TGJ 0.3M	---
		No	E2EW-X5D118-M1TGJ-T 0.3M	---
M30 (10 mm)	Pre-wired (2 m) *1	Yes	E2EW-X10D130 2M	E2EW-X10D230 2M
	M12 Pre-wired Smartclick Connector (0.3 m)	Yes	E2EW-X10D130-M1TGJ 0.3M	---
		No	E2EW-X10D130-M1TGJ-T 0.3M	---

*1. Models with 5-m cable length are also available with "5M" suffix. (Example: E2EW-X3D112 5M)

Note: 1. When embedding the Proximity Sensor in metal, refer to *Influence of Surrounding Metal* on page 35.

2. IO-Link is not supported for BASIC Model.

BASIC Model

E2EW-Q Series (Spatter-resistant Double distance model)

DC 2-wire [Refer to *Ratings and Specifications* on page 24, *Dimensions* on page 37.]

Size (Sensing distance)	Connection method	Polarity	Model	
			Operation mode: NO	Operation mode: NC
M12 (3 mm)	Pre-wired (2 m) *1	Yes	E2EW-QX3D112 2M	E2EW-QX3D212 2M
	M12 Pre-wired Smartclick Connector (0.3 m)	Yes	E2EW-QX3D112-M1TGJ 0.3M	---
		No	E2EW-QX3D112-M1TGJ-T 0.3M	---
M18 (7 mm)	Pre-wired (2 m) *1	Yes	E2EW-QX7D118 2M	E2EW-QX7D218 2M
	M12 Pre-wired Smartclick Connector (0.3 m)	Yes	E2EW-QX7D118-M1TGJ 0.3M	---
		No	E2EW-QX7D118-M1TGJ-T 0.3M	---
M30 (12 mm)	Pre-wired (2 m) *1	Yes	E2EW-QX12D130 2M	E2EW-QX12D230 2M
	M12 Pre-wired Smartclick Connector (0.3 m)	Yes	E2EW-QX12D130-M1TGJ 0.3M	---
		No	E2EW-QX12D130-M1TGJ-T 0.3M	---

BASIC Model

E2EW-Q Series (Spatter-resistant Single distance model)

DC 2-wire [Refer to *Ratings and Specifications* on page 24, *Dimensions* on page 37.]

Size (Sensing distance)	Connection method	Polarity	Model	
			Operation mode: NO	Operation mode: NC
M12 (2 mm)	Pre-wired (2 m) *1	Yes	E2EW-QX2D112 2M	E2EW-QX2D212 2M
	M12 Pre-wired Smartclick Connector (0.3 m)	Yes	E2EW-QX2D112-M1TGJ 0.3M	---
		No	E2EW-QX2D112-M1TGJ-T 0.3M	---
M18 (5 mm)	Pre-wired (2 m) *1	Yes	E2EW-QX5D118 2M	E2EW-QX5D218 2M
	M12 Pre-wired Smartclick Connector (0.3 m)	Yes	E2EW-QX5D118-M1TGJ 0.3M	---
		No	E2EW-QX5D118-M1TGJ-T 0.3M	---
M30 (10 mm)	Pre-wired (2 m) *1	Yes	E2EW-QX10D130 2M	E2EW-QX10D230 2M
	M12 Pre-wired Smartclick Connector (0.3 m)	Yes	E2EW-QX10D130-M1TGJ 0.3M	---
		No	E2EW-QX10D130-M1TGJ-T 0.3M	---

*1. NO models with polarity are also available with a 5-m cable: suffix 5M (Example: E2EW-QX3D112 5M).

Note: 1. When embedding the Proximity Sensor in metal, refer to *Influence of Surrounding Metal* on page 35.
 2. IO-Link is not supported for BASIC Model.

E2EW Series

BASIC Model

E2EW Series (Double distance model)

DC 3-wire [Refer to Ratings and Specifications on page 25, Dimensions on page 37.]

Size (Sensing distance)	Connection method	Operation mode *3	Model	
			PNP	NPN
M12 (3 mm)	Pre-wired (2 m) *1	NO	E2EW-X3B112 2M	E2EW-X3C112 2M
		NO+NC	E2EW-X3B312 2M	E2EW-X3C312 2M
	M12 Pre-wired Smartclick Connector (0.3 m)	NO	E2EW-X3B112-M1TJ 0.3M	E2EW-X3C112-M1TJ 0.3M
		NO+NC	E2EW-X3B312-M1TJ 0.3M	E2EW-X3C312-M1TJ 0.3M
M18 (7 mm)	Pre-wired (2 m) *1	NO	E2EW-X7B118 2M	E2EW-X7C118 2M
		NO+NC	E2EW-X7B318 2M	E2EW-X7C318 2M
	M12 Pre-wired Smartclick Connector (0.3 m)	NO	E2EW-X7B118-M1TJ 0.3M	E2EW-X7C118-M1TJ 0.3M
		NO+NC	E2EW-X7B318-M1TJ 0.3M	E2EW-X7C318-M1TJ 0.3M
M30 (12 mm)	Pre-wired (2 m) *1	NO	E2EW-X12B130 2M	E2EW-X12C130 2M
		NO+NC	E2EW-X12B330 2M	E2EW-X12C330 2M
	M12 Pre-wired Smartclick Connector (0.3 m)	NO	E2EW-X12B130-M1TJ 0.3M	E2EW-X12C130-M1TJ 0.3M
		NO+NC	E2EW-X12B330-M1TJ 0.3M	E2EW-X12C330-M1TJ 0.3M

BASIC Model

E2EW Series (Single distance model)

DC 3-wire [Refer to Ratings and Specifications on page 25, Dimensions on page 37.]

Size (Sensing distance)	Connection method *2	Operation mode *3	Model	
			PNP	NPN
M12 (2 mm)	Pre-wired (2 m) *1	NO	E2EW-X2B112 2M	E2EW-X2C112 2M
		NO+NC	E2EW-X2B312 2M	E2EW-X2C312 2M
	M12 Pre-wired Smartclick Connector (0.3 m)	NO	E2EW-X2B112-M1TJ 0.3M	E2EW-X2C112-M1TJ 0.3M
		NO+NC	E2EW-X2B312-M1TJ 0.3M	E2EW-X2C312-M1TJ 0.3M
M18 (5 mm)	Pre-wired (2 m) *1	NO	E2EW-X5B118 2M	E2EW-X5C118 2M
		NO+NC	E2EW-X5B318 2M	E2EW-X5C318 2M
	M12 Pre-wired Smartclick Connector (0.3 m)	NO	E2EW-X5B118-M1TJ 0.3M	E2EW-X5C118-M1TJ 0.3M
		NO+NC	E2EW-X5B318-M1TJ 0.3M	E2EW-X5C318-M1TJ 0.3M
M30 (10 mm)	Pre-wired (2 m) *1	NO	E2EW-X10B130 2M	E2EW-X10C130 2M
		NO+NC	E2EW-X10B330 2M	E2EW-X10C330 2M
	M12 Pre-wired Smartclick Connector (0.3 m)	NO	E2EW-X10B130-M1TJ 0.3M	E2EW-X10C130-M1TJ 0.3M
		NO+NC	E2EW-X10B330-M1TJ 0.3M	E2EW-X10C330-M1TJ 0.3M

*1. Models with 5-m cable length are also available with "5M" suffix. (Example: E2EW-X3B112 5M)

*2. Model with M12 Connector are also available with "-M1" suffix. (Example: E2EW-X2B112 -M1)

*3. Operation model NC are also available with "E2EW-X□□2□□". (Example: E2EW-X3B212 2M)

Note: 1. When embedding the Proximity Sensor in metal, refer to *Influence of Surrounding Metal* on page 35.

2. IO-Link is not supported for all types of BASIC Model.

BASIC Model

E2EW-Q Series (Spatter-resistant Double distance model)

DC 3-wire [Refer to *Ratings and Specifications* on page 25, *Dimensions* on page 37.]

Size (Sensing distance)	Connection method	Operation mode *2	Model	
			PNP	NPN
M12 (3 mm)	Pre-wired (2 m) *1	NO	E2EW-QX3B112 2M	E2EW-QX3C112 2M
		NO+NC	E2EW-QX3B312 2M	E2EW-QX3C312 2M
	M12 Pre-wired Smartclick Connector (0.3 m)	NO	E2EW-QX3B112-M1TJ 0.3M	E2EW-QX3C112-M1TJ 0.3M
		NO+NC	E2EW-QX3B312-M1TJ 0.3M	E2EW-QX3C312-M1TJ 0.3M
M18 (7 mm)	Pre-wired (2 m) *1	NO	E2EW-QX7B118 2M	E2EW-QX7C118 2M
		NO+NC	E2EW-QX7B318 2M	E2EW-QX7C318 2M
	M12 Pre-wired Smartclick Connector (0.3 m)	NO	E2EW-QX7B118-M1TJ 0.3M	E2EW-QX7C118-M1TJ 0.3M
		NO+NC	E2EW-QX7B318-M1TJ 0.3M	E2EW-QX7C318-M1TJ 0.3M
M30 (12 mm)	Pre-wired (2 m) *1	NO	E2EW-QX12B130 2M	E2EW-QX12C130 2M
		NO+NC	E2EW-QX12B330 2M	E2EW-QX12C330 2M
	M12 Pre-wired Smartclick Connector (0.3 m)	NO	E2EW-QX12B130-M1TJ 0.3M	E2EW-QX12C130-M1TJ 0.3M
		NO+NC	E2EW-QX12B330-M1TJ 0.3M	E2EW-QX12C330-M1TJ 0.3M

BASIC Model

E2EW-Q Series (Spatter-resistant Single distance model)

DC 3-wire [Refer to *Ratings and Specifications* on page 25, *Dimensions* on page 37.]

Size (Sensing distance)	Connection method	Operation mode *2	Model	
			PNP	NPN
M12 (2 mm)	Pre-wired (2 m) *1	NO	E2EW-QX2B112 2M	E2EW-QX2C112 2M
		NO+NC	E2EW-QX2B312 2M	E2EW-QX2C312 2M
	M12 Pre-wired Smartclick Connector (0.3 m)	NO	E2EW-QX2B112-M1TJ 0.3M	E2EW-QX2C112-M1TJ 0.3M
		NO+NC	E2EW-QX2B312-M1TJ 0.3M	E2EW-QX2C312-M1TJ 0.3M
M18 (5 mm)	Pre-wired (2 m) *1	NO	E2EW-QX5B118 2M	E2EW-QX5C118 2M
		NO+NC	E2EW-QX5B318 2M	E2EW-QX5C318 2M
	M12 Pre-wired Smartclick Connector (0.3 m)	NO	E2EW-QX5B118-M1TJ 0.3M	E2EW-QX5C118-M1TJ 0.3M
		NO+NC	E2EW-QX5B318-M1TJ 0.3M	E2EW-QX5C318-M1TJ 0.3M
M30 (10 mm)	Pre-wired (2 m) *1	NO	E2EW-QX10B130 2M	E2EW-QX10C130 2M
		NO+NC	E2EW-QX10B330 2M	E2EW-QX10C330 2M
	M12 Pre-wired Smartclick Connector (0.3 m)	NO	E2EW-QX10B130-M1TJ 0.3M	E2EW-QX10C130-M1TJ 0.3M
		NO+NC	E2EW-QX10B330-M1TJ 0.3M	E2EW-QX10C330-M1TJ 0.3M

*1. Models with 5-m cable length are also available with "5M" suffix. (Example: E2EW-QX3B112 5M)

*2. Operation model NC are also available with "E2EW-X□□2□□". (Example: E2EW-QX3B212 2M)

Note: 1. When embedding the Proximity Sensor in metal, refer to *Influence of Surrounding Metal* on page 35.

2. IO-Link is not supported for all types of BASIC Model.

E2EW Series

PREMIUM Model

E2EW Series (Quadruple distance model)

DC 3-wire [Refer to Ratings and Specifications on page 26, Dimensions on page 38.]

Size (Sensing distance)	Connection method *2	Operation mode *3	Model	
			PNP	NPN
M12 (7 mm)	Pre-wired (2 m) *1	NO	E2EW-X7B1T12 2M	E2EW-X7C112 2M
		NO+NC	E2EW-X7B3T12 2M	E2EW-X7C312 2M
	M12 Pre-wired Smartclick Connector (0.3 m)	NO	E2EW-X7B1T12-M1TJ 0.3M	E2EW-X7C112-M1TJ 0.3M
		NO+NC	E2EW-X7B3T12-M1TJ 0.3M	E2EW-X7C312-M1TJ 0.3M
M18 (12 mm)	Pre-wired (2 m) *1	NO	E2EW-X12B1T18 2M	E2EW-X12C118 2M
		NO+NC	E2EW-X12B3T18 2M	E2EW-X12C318 2M
	M12 Pre-wired Smartclick Connector (0.3 m)	NO	E2EW-X12B1T18-M1TJ 0.3M	E2EW-X12C118-M1TJ 0.3M
		NO+NC	E2EW-X12B3T18-M1TJ 0.3M	E2EW-X12C318-M1TJ 0.3M
M30 (22 mm)	Pre-wired (2 m) *1	NO	E2EW-X22B1T30 2M	E2EW-X22C130 2M
		NO+NC	E2EW-X22B3T30 2M	E2EW-X22C330 2M
	M12 Pre-wired Smartclick Connector (0.3 m)	NO	E2EW-X22B1T30-M1TJ 0.3M	E2EW-X22C130-M1TJ 0.3M
		NO+NC	E2EW-X22B3T30-M1TJ 0.3M	E2EW-X22C330-M1TJ 0.3M

PREMIUM Model

E2EW Series (Triple distance model)

DC 3-wire [Refer to Ratings and Specifications on page 26, Dimensions on page 38.]

Size (Sensing distance)	Connection method *2	Operation mode *3	Model	
			PNP	NPN
M12 (6 mm)	Pre-wired (2 m) *1	NO	E2EW-X6B1T12 2M	E2EW-X6C112 2M
		NO+NC	E2EW-X6B3T12 2M	E2EW-X6C312 2M
	M12 Pre-wired Smartclick Connector (0.3 m)	NO	E2EW-X6B1T12-M1TJ 0.3M	E2EW-X6C112-M1TJ 0.3M
		NO+NC	E2EW-X6B3T12-M1TJ 0.3M	E2EW-X6C312-M1TJ 0.3M
M18 (10 mm)	Pre-wired (2 m) *1	NO	E2EW-X10B1T18 2M	E2EW-X10C118 2M
		NO+NC	E2EW-X10B3T18 2M	E2EW-X10C318 2M
	M12 Pre-wired Smartclick Connector (0.3 m)	NO	E2EW-X10B1T18-M1TJ 0.3M	E2EW-X10C118-M1TJ 0.3M
		NO+NC	E2EW-X10B3T18-M1TJ 0.3M	E2EW-X10C318-M1TJ 0.3M
M30 (20 mm)	Pre-wired (2 m) *1	NO	E2EW-X20B1T30 2M	E2EW-X20C130 2M
		NO+NC	E2EW-X20B3T30 2M	E2EW-X20C330 2M
	M12 Pre-wired Smartclick Connector (0.3 m)	NO	E2EW-X20B1T30-M1TJ 0.3M	E2EW-X20C130-M1TJ 0.3M
		NO+NC	E2EW-X20B3T30-M1TJ 0.3M	E2EW-X20C330-M1TJ 0.3M

*1. Models with 5-m cable length are also available with "5M" suffix. (Example: E2EW-X7B1T12 5M)

*2. Model with M12 Connector are also available with "-M1" suffix. (Example: E2EW-X7B1T12 -M1)

*3. Operation mode NC are also available with "E2EW-X□□2□□". (Example: E2EW-X7B212 2M)

Note: 1. When embedding the Proximity Sensor in metal, refer to *Influence of Surrounding Metal* on page 35.

2. Models in are equipped with IO-Link (COM3). For IO-Link (COM2), select a model number with the format "E2EW-X□□□D□" (Example: E2EW-X7B1D12 2M).

Operation mode NO can be changed to NC via IO-Link communications.

3. IO-Link is not supported for NC-type PNP outputs or all types of NPN outputs.

PREMIUM Model

E2EW-Q Series (Spatter-resistant Quadruple distance model)

DC 3-wire [Refer to Ratings and Specifications on page 26, Dimensions on page 38.]

Size (Sensing distance)	Connection method *2	Operation mode *3	Model	
			PNP	NPN
M12 (7 mm)	Pre-wired (2 m) *1	NO	E2EW-QX7B1T12 2M	E2EW-QX7C112 2M
		NO+NC	E2EW-QX7B3T12 2M	E2EW-QX7C312 2M
	M12 Pre-wired Smartclick Connector (0.3 m)	NO	E2EW-QX7B1T12-M1TJ 0.3M	E2EW-QX7C112-M1TJ 0.3M
		NO+NC	E2EW-QX7B3T12-M1TJ 0.3M	E2EW-QX7C312-M1TJ 0.3M
M18 (12 mm)	Pre-wired (2 m) *1	NO	E2EW-QX12B1T18 2M	E2EW-QX12C118 2M
		NO+NC	E2EW-QX12B3T18 2M	E2EW-QX12C318 2M
	M12 Pre-wired Smartclick Connector (0.3 m)	NO	E2EW-QX12B1T18-M1TJ 0.3M	E2EW-QX12C118-M1TJ 0.3M
		NO+NC	E2EW-QX12B3T18-M1TJ 0.3M	E2EW-QX12C318-M1TJ 0.3M
M30 (22 mm)	Pre-wired (2 m) *1	NO	E2EW-QX22B1T30 2M	E2EW-QX22C130 2M
		NO+NC	E2EW-QX22B3T30 2M	E2EW-QX22C330 2M
	M12 Pre-wired Smartclick Connector (0.3 m)	NO	E2EW-QX22B1T30-M1TJ 0.3M	E2EW-QX22C130-M1TJ 0.3M
		NO+NC	E2EW-QX22B3T30-M1TJ 0.3M	E2EW-QX22C330-M1TJ 0.3M

PREMIUM Model

E2EW-Q Series (Spatter-resistant Triple distance model)

DC 3-wire [Refer to Ratings and Specifications on page 26, Dimensions on page 38.]

Size (Sensing distance)	Connection method *2	Operation mode *3	Model	
			PNP	NPN
M12 (6 mm)	Pre-wired (2 m) *1	NO	E2EW-QX6B1T12 2M	E2EW-QX6C112 2M
		NO+NC	E2EW-QX6B3T12 2M	E2EW-QX6C312 2M
	M12 Pre-wired Smartclick Connector (0.3 m)	NO	E2EW-QX6B1T12-M1TJ 0.3M	E2EW-QX6C112-M1TJ 0.3M
		NO+NC	E2EW-QX6B3T12-M1TJ 0.3M	E2EW-QX6C312-M1TJ 0.3M
M18 (10 mm)	Pre-wired (2 m) *1	NO	E2EW-QX10B1T18 2M	E2EW-QX10C118 2M
		NO+NC	E2EW-QX10B3T18 2M	E2EW-QX10C318 2M
	M12 Pre-wired Smartclick Connector (0.3 m)	NO	E2EW-QX10B1T18-M1TJ 0.3M	E2EW-QX10C118-M1TJ 0.3M
		NO+NC	E2EW-QX10B3T18-M1TJ 0.3M	E2EW-QX10C318-M1TJ 0.3M
M30 (20 mm)	Pre-wired (2 m) *1	NO	E2EW-QX20B1T30 2M	E2EW-QX20C130 2M
		NO+NC	E2EW-QX20B3T30 2M	E2EW-QX20C330 2M
	M12 Pre-wired Smartclick Connector (0.3 m)	NO	E2EW-QX20B1T30-M1TJ 0.3M	E2EW-QX20C130-M1TJ 0.3M
		NO+NC	E2EW-QX20B3T30-M1TJ 0.3M	E2EW-QX20C330-M1TJ 0.3M

*1. Models with 5-m cable length are also available with "5M" suffix. (Example: E2EW-QX7B1T12 5M)

*2. Model with M12 Connector are also available with "-M1" suffix. (Example: E2EW-QX7B1T12 -M1)

*3. Operation model NC are also available with "E2EW-X□□2□□". (Example: E2EW-QX7B212 2M)

Note: 1. When embedding the Proximity Sensor in metal, refer to *Influence of Surrounding Metal* on page 35.2. Models in are equipped with IO-Link (COM3). For IO-Link (COM2), select a model number with the format of "E2EW-QX□□□□D□" (Example: E2EW-QX7B1D12 2M).
Operation mode NO can be changed to NC via IO-Link communications.

3. IO-Link is not supported for NC-type PNP outputs or all types of NPN outputs.

Sensor I/O Connectors (Sold Separately)

For details of the connector, refer to XS5 Series on page 70.

E2EW Series

Ratings and Specifications

BASIC Model

E2EW Series (Double distance model/Single distance model)

E2EW-Q Series (Spatter-resistant Double distance model/Spatter-resistant Single distance model)

DC 2-wire

Item	Type	Double distance model/ Spatter-resistant Double distance model			Single distance model/ Spatter-resistant Single distance model		
	Size	M12	M18	M30	M12	M18	M30
	Model	E2EW- (Q)X3D□12	E2EW- (Q)X7D□18	E2EW- (Q)X12D□30	E2EW- (Q)X2D□12	E2EW- (Q)X5D□18	E2EW- (Q)X10D□30
Sensing distance		3 mm ±10%	7 mm ±10%	12 mm ±10%	2 mm ±10%	5 mm ±10%	10 mm ±10%
Setting distance		0 to 2.1 mm	0 to 4.9 mm	0 to 8.4 mm	0 to 1.4 mm	0 to 3.5 mm	0 to 7 mm
Differential travel		15% max. of sensing distance			10% max. of sensing distance		
Detectable object		Ferrous metals and non-ferrous metals (The sensing distance depends on the material of the sensing object. Refer to <i>Engineering Data</i> on page 27.)					
Standard sensing object (Iron)		21 × 21 × 1 mm	30 × 30 × 1 mm	54 × 54 × 1 mm	12 × 12 × 1 mm	18 × 18 × 1 mm	30 × 30 × 1 mm
Response frequency *1		80 Hz	90 Hz	50 Hz	100 Hz	80 Hz	40 Hz
Power supply voltage		10 to 30 VDC (including 10% ripple (p-p)), Class 2					
Leakage current		0.8 mA max.					
Output configuration		□ models: Polarity D1-T models: No polarity					
Operation mode		D1 models: NO (Normally open), D2 models: NC (Normally closed)					
Control output	Load current	3 to 100 mA					
	Residual voltage	Polarity: 3 V max. (Load current: 100 mA, Cable length: 2 m) No polarity: 5 V max. (Load current: 100 mA, Cable length: 2 m)					
Indicator		D1 models: Operation indicator (orange, lit) and communication indicator (green, not lit) D2 models: Operation indicator (orange, lit)					
Protection circuits		Surge suppressor, Output short-circuit protection					
Ambient temperature range		Operating: 0 to 85 °C, Storage: -15 to 85 °C (with no icing or condensation) *2					
Ambient humidity range		Operating/Storage: 35% to 95% (with no condensation)					
Temperature influence		±20% max. of sensing distance at 23 °C in the temperature range of 0 to 85 °C					
Voltage influence		±1.5% max. of sensing distance at rated voltage in the rated voltage ±15% range					
Insulation resistance		50 MΩ min. (at 500 VDC) between current-carrying parts and case					
Dielectric strength		1,000 VAC, 50/60 Hz for 1 minute between current-carrying parts and case					
Vibration resistance (destruction)		10 to 55 Hz, 1.5-mm double amplitude for 2 hours each in X, Y, and Z directions					
Shock resistance (destruction)		1,000 m/s ² 10 times each in X, Y, and Z directions					
Degree of protection		IEC 60529: IP67					
Connection method		Pre-wired Models (Standard cable length: 2 m), Pre-wired Connector Models (Standard cable length: 0.3 m)					
Weight (packed state)	Pre-wired	Approx. 140 g	Approx. 165 g	Approx. 225 g	Approx. 140 g	Approx. 160 g	Approx. 225 g
	M12 Pre-wired Smartclick Connector	Approx. 70 g	Approx. 100 g	Approx. 160 g	Approx. 70 g	Approx. 95 g	Approx. 160 g
Materials	Case	E2EW-X□: Stainless steel (SUS303), E2EW-QX□: Fluororesin coating (Base material: (SUS303))					
	Sensing surface	E2EW-X□: Stainless steel (SUS303), E2EW-QX□: Fluororesin coating (Base material: (SUS303))					
	Sensing surface (Thickness)	0.4 mm	0.4 mm	0.5 mm	0.8 mm	0.8 mm	0.8 mm
	Clamping nuts	E2EW-X□: Stainless steel (SUS303), E2EW-QX□: Fluororesin coating (Base material: (SUS303))					
	Toothed washers	Zinc-plated iron					
Cable	Vinyl chloride (PVC)						
Accessories		Instruction manual, Clamping nuts, Toothed washer					

*1. The response frequency is an average value. Measurement conditions are as follows: standard sensing object, a distance of twice the standard sensing object, and a set distance of half the sensing distance.

*2. UL temperature rating is between 0 °C to 60 °C.

BASIC Model

E2EW Series (Double distance mode/Single distance model)

E2EW-Q Series (Spatter-resistant Double distance model/Spatter-resistant Single distance model)

DC 3-wire

Item	Type Size Model	Double distance model/ Spatter-resistant Double distance model			Single distance model/ Spatter-resistant Single distance model		
		M12	M18	M30	M12	M18	M30
		E2EW- (Q)X3□12	E2EW- (Q)X7□18	E2EW- (Q)X12□30	E2EW- (Q)X2□12	E2EW- (Q)X5□18	E2EW- (Q)X10□30
Sensing distance		3 mm ±10%	7 mm ±10%	12 mm ±10%	2 mm ±10%	5 mm ±10%	10 mm ±10%
Setting distance		0 to 2.1 mm	0 to 4.9 mm	0 to 8.4 mm	0 to 1.4 mm	0 to 3.5 mm	0 to 7 mm
Differential travel		15% max. of sensing distance			10% max. of sensing distance		
Detectable object		Ferrous metals and non-ferrous metals (The sensing distance depends on the material of the sensing object. Refer to <i>Engineering Data</i> on page 27.)					
Standard sensing object (Iron)		21 × 21 × 1 mm	30 × 30 × 1 mm	54 × 54 × 1 mm	12 × 12 × 1 mm	18 × 18 × 1 mm	30 × 30 × 1 mm
Response frequency *1		80 Hz	90 Hz	50 Hz	100 Hz	80 Hz	40 Hz
Power supply voltage		10 to 30 VDC (including 10% ripple (p-p)), Class 2					
Current consumption		1-output models (B1, B2, C1, C2): 16 mA max. 2-output models (B3, C3): 20 mA max.					
Output configuration		B□ Models: PNP open collector, C□ Models: NPN open collector					
Operation mode		1-output models (B1, C1): NO (Normally open), 1-output models (B2, C2): NC (Normally closed), 2-output models (B3, C3): NO+NC (Normally open, Normally closed)					
Control output	Load current	1-output models (B1, B2, C1, C2): 10 to 30 VDC, Class 2, 200 mA max. 2-output models (B3, C3): 10 to 30 VDC, Class 2, 100 mA max.					
	Residual voltage	1-output models (B1, B2, C1, C2): 2 V max. (Load current: 200 mA, Cable length: 2 m) 2-output models (B3, C3): 2 V max. (Load current: 100 mA, Cable length: 2 m)					
Indicator		Operation indicator (orange, lit) and communication indicator (green, not lit)					
Protection circuits		Power supply reverse polarity protection, Surge suppressor, Output short-circuit protection, Output reverse polarity protection					
Ambient temperature range		Operating: 0 to 85 °C, Storage: -15 to 85 °C (with no icing or condensation) *2					
Ambient humidity range		Operating/Storage: 35% to 95% (with no condensation)					
Temperature influence		±20% max. of sensing distance at 23 °C in the temperature range of 0 to 85 °C					
Voltage influence		±1.5% max. of sensing distance at rated voltage in the rated voltage ±15% range					
Insulation resistance		50 MΩ min. (at 500 VDC) between current-carrying parts and case					
Dielectric strength		1,000 VAC, 50/60 Hz for 1 minute between current-carrying parts and case					
Vibration resistance (destruction)		10 to 55 Hz, 1.5-mm double amplitude for 2 hours each in X, Y, and Z directions					
Shock resistance (destruction)		1,000 m/s ² 10 times each in X, Y, and Z directions					
Degree of protection		IEC 60529: IP67					
Connection method		Pre-wired Models (Standard cable length: 2 m), Pre-wired Connector Models (Standard cable length: 0.3 m), M12 Connector Models *3					
Weight (packed state)	Pre-wired	Approx. 140 g	Approx. 165 g	Approx. 225 g	Approx. 140 g	Approx. 160 g	Approx. 225 g
	M12 Pre-wired Smartclick Connector	Approx. 70 g	Approx. 100 g	Approx. 160 g	Approx. 70 g	Approx. 95 g	Approx. 160 g
	M12 Connector	---	---	---	Approx. 60 g	Approx. 75 g	Approx. 135 g
Materials	Case	E2EW-X□: Stainless steel (SUS303), E2EW-QX□: Fluororesin coating (Base material: (SUS303))					
	Sensing surface	E2EW-X□: Stainless steel (SUS303), E2EW-QX□: Fluororesin coating (Base material: (SUS303))					
	Sensing surface (Thickness)	0.4 mm	0.4 mm	0.5 mm	0.8 mm	0.8 mm	0.8 mm
	Clamping nuts	E2EW-X□: Stainless steel (SUS303), E2EW-QX□: Fluororesin coating (Base material: (SUS303))					
	Toothed washers	Zinc-plated iron					
Cable	Vinyl chloride (PVC)						
Accessories		Instruction manual, Clamping nuts, Toothed washer					

*1. The response frequency is an average value. Measurement conditions are as follows: standard sensing object, a distance of twice the standard sensing object, and a set distance of half the sensing distance.

*2. UL temperature rating is between 0 °C to 60 °C.

*3. The spatter-resistant model is not available.

PREMIUM Model

E2EW Series (Quadruple/Triple distance model)

E2EW-Q Series (Spatter-resistant Quadruple/Triple distance model)

DC 3-wire

		Type	Quadruple distance model/ Spatter-resistant Double distance model			Triple distance model/ Spatter-resistant Triple distance model		
			Size	M12	M18	M30	M12	M18
Item	Model		E2EW-(Q)X7□12	E2EW-(Q)X12□18	E2EW-(Q)X22□30	E2EW-(Q)X6□12	E2EW-(Q)X10□18	E2EW-(Q)X20□30
Sensing distance			7 mm ±10%	12 mm ±10%	22 mm ±10%	6 mm ±10%	10 mm ±10%	20 mm ±10%
Setting distance			0 to 4.9 mm	0 to 8.4 mm	0 to 15.4 mm	0 to 4.2 mm	0 to 7.0 mm	0 to 14 mm
Differential travel			15% max. of sensing distance					
Detectable object			Ferrous metals and non-ferrous metals (The sensing distance depends on the material of the sensing object. Refer to <i>Engineering Data</i> on page 27.)					
Standard sensing object (Iron)			21 × 21 × 1 mm	36 × 36 × 1 mm	66 × 66 × 1 mm	18 × 18 × 1 mm	30 × 30 × 1 mm	60 × 60 × 1 mm
Response frequency *1			2 Hz (Equipped with a function, which effectively cancels pulse noise of current magnetic field.)					
Power supply voltage			10 to 30 VDC (including 10% ripple (p-p)), Class 2					
Current consumption			720 mW max. (Current consumption: 30 mA max. at power supply voltage of 24 V)					
Output configuration			B□ Models: PNP open collector, C□ Models: NPN open collector					
Operation mode			1-output models (B1, C1): NO (Normally open), 1-output models (B2, C2): NC (Normally closed), 2-output models (B3, C3): NO+NC (Normally open, Normally closed)					
Control output	Load current		1-output models (B1, B2, C1, C2): 10 to 30 VDC, Class 2, 200 mA max. 2-output models (B3, C3): 10 to 30 VDC, Class 2, 100 mA max.					
	Residual voltage		1-output models (B1, B2, C1, C2): 2 V max. (Load current: 200 mA, Cable length: 2 m) 2-output models (B3, C3): 2 V max. (Load current: 100 mA, Cable length: 2 m)					
Indicator			In the Standard I/O mode (SIO mode): Operation indicator (orange, lit) and communication indicator (green, not lit) In the IO-Link communication mode (COM mode): Operation indicator (orange, lit) and communication indicator (green, blinking at 1 s intervals)					
Protection circuits			Power supply reverse polarity protection, Surge suppressor, Output short-circuit protection, Output reverse polarity protection					
Ambient temperature range			Operating: 0 to 85 °C, Storage: -15 to 85 °C (with no icing or condensation) *3					
Ambient humidity range			Operating/Storage: 35% to 95% (with no condensation)					
Temperature influence			±20% max. of sensing distance at 23 °C in the temperature range of 0 to 85 °C					
Voltage influence			±1.5% max. of sensing distance at rated voltage in the rated voltage ±15% range					
Insulation resistance			50 MΩ min. (at 500 VDC) between current-carrying parts and case					
Dielectric strength			1,000 VAC, 50/60 Hz for 1 minute between current-carrying parts and case					
Vibration resistance (destruction)			10 to 55 Hz, 1.5-mm double amplitude for 2 hours each in X, Y, and Z directions					
Shock resistance (destruction)			1,000 m/s ² 10 times each in X, Y, and Z directions					
Degree of protection			IEC 60529: IP67					
Connection method			Pre-wired Models (Standard cable length: 2 m), Pre-wired Connector Models (Standard cable length: 0.3 m), M12 Connector Models					
Weight (packed state)	Pre-wired		Approx. 140 g	Approx. 165 g	Approx. 225 g	Approx. 140 g	Approx. 165 g	Approx. 225 g
	M12 Pre-wired Smartclick Connector		Approx. 70 g	Approx. 100 g	Approx. 160 g	Approx. 70 g	Approx. 100 g	Approx. 160 g
	M12 Connector		Approx. 60 g	Approx. 75 g	Approx. 135 g	Approx. 60 g	Approx. 75 g	Approx. 135 g
Materials	Case		E2EW-X□: Stainless steel (SUS303), E2EW-QX□: Fluororesin coating (Base material: (SUS303))					
	Sensing surface		E2EW-X□: Stainless steel (SUS303), E2EW-QX□: Fluororesin coating (Base material: (SUS303))					
	Sensing surface (Thickness)		0.4 mm	0.4 mm	0.5 mm	0.4 mm	0.4 mm	0.5 mm
	Clamping nuts		E2EW-X□: Stainless steel (SUS303), E2EW-QX□: Fluororesin coating (Base material: (SUS303))					
	Toothed washers		Zinc-plated iron					
Cable			Vinyl chloride (PVC)					
Main IO-Link functions *2			Operation mode switching between NO and NC, self diagnosis enabling, excessive proximity judgment distance selecting, timer function of the control output and timer time selecting, instability output (IO-Link mode) ON delay timer time selecting function, monitor output, operating hours read-out, readout of the sensor internal temperature, and initial reset					
IO-Link Communication specifications *2	IO-Link specification		Ver.1.1					
	Baud rate		E2EW-(Q) X□B□□□: COM3 (230.4 kbps), E2EW-(Q) X□B□□□: COM2 (38.4 kbps)					
	Data length		PD size: 2 bytes, OD size: 1 byte (M-sequence type: TYPE_2_2)					
	Minimum cycle time		COM2: 2.3 ms, COM3: 1.0 ms					
Accessories			Instruction manual, Clamping nuts, Toothed washer					

*1. The response frequency is an average value. Factory setting: (timer function: ONOFF delay)

*2. IO-Link is not supported for NC-type PNP outputs or all types of NPN outputs.

*3. UL temperature rating is between 0 °C to 60 °C.

Engineering Data (Reference Value)

Sensing Area

BASIC Model

DC 2-wire/DC 3-wire
Double distance model/
Spatter-resistant Double distance model
Sensing object: iron

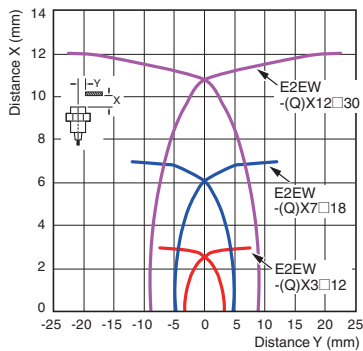

DC 2-wire/DC 3-wire
Single distance model/
Spatter-resistant Single distance model
Sensing object: iron

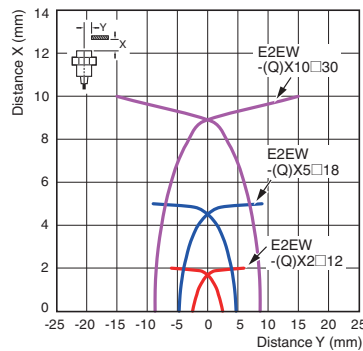

E2EW Series

E2EF/E2FM Series

E2EQ NEXT Series

E2EQ Series

XS5 Series

PREMIUM Model

DC 3-wire
Quadruple distance model/
Spatter-resistant Quadruple distance model
Sensing object: iron

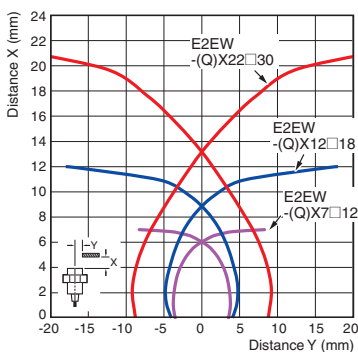

Sensing object: Aluminum

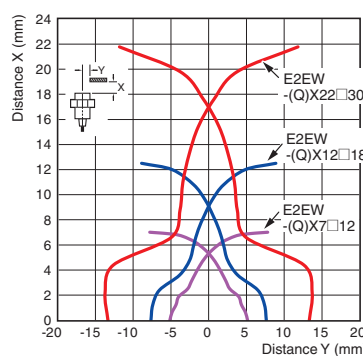

DC 3-wire
Triple distance model/
Spatter-resistant Triple distance model
Sensing object: iron

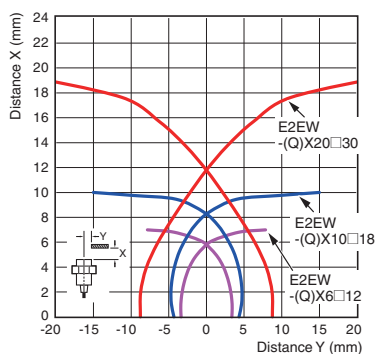

Sensing object: Aluminum

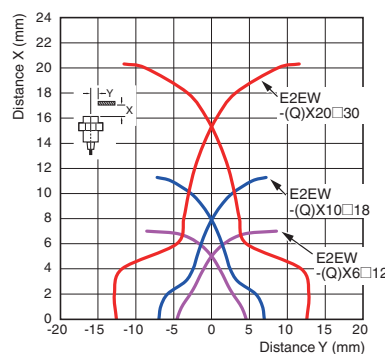

Influence of Sensing Object Size and Material

BASIC Model

DC 2-wire/DC 3-wire
Double distance model/
Spatter-resistant
Double distance model

Size: M12
 E2EW-(Q)X3□12

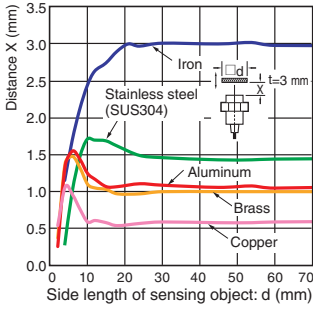

Size: M18
 E2EW-(Q)X7□18

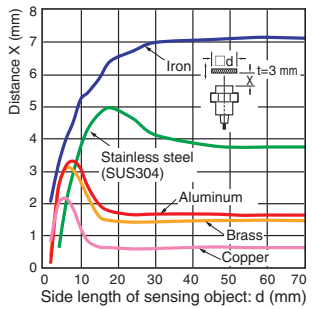

Size: M30
 E2EW-(Q)X12□30

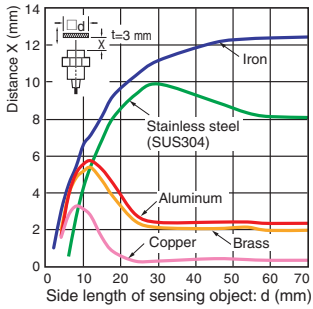

DC 2-wire/DC 3-wire
Single distance model/
Spatter-resistant
Single distance model

Size: M12
 E2EW-(Q)X2□12

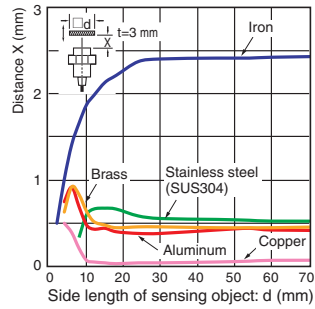

Size: M18
 E2EW-(Q)X5□18

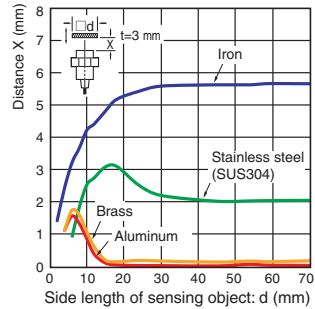

Size: M30
 E2EW-(Q)X10□30

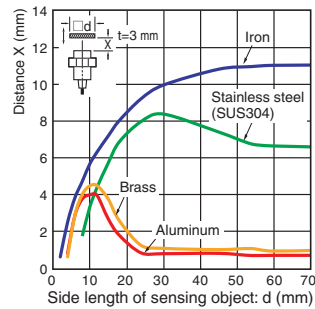

PREMIUM Model

DC 3-wire
Quadruple distance model/
Spatter-resistant
Quadruple distance model

Size: M12
 E2EW-(Q)X7□12

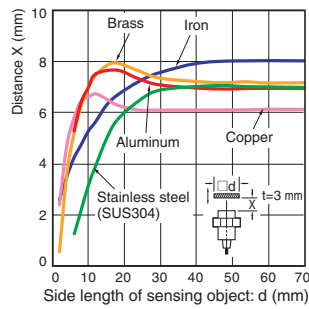

Size: M18
 E2EW-(Q)X12□18

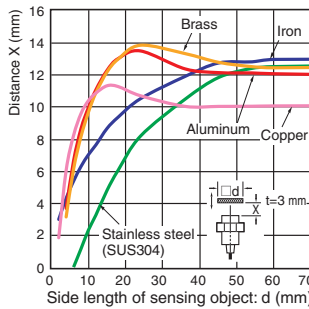

Size: M30
 E2EW-(Q)X22□30

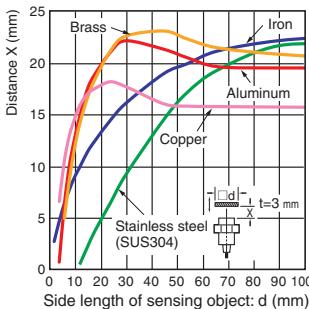

DC 3-wire
Triple distance model/
Spatter-resistant
Triple distance model

Size: M12
 E2EW-(Q)X6□12

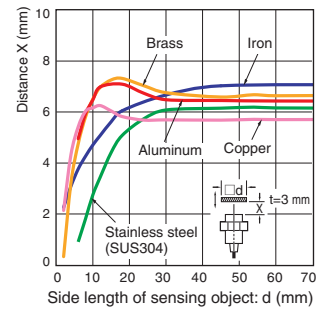

Size: M18
 E2EW-(Q)X10□18

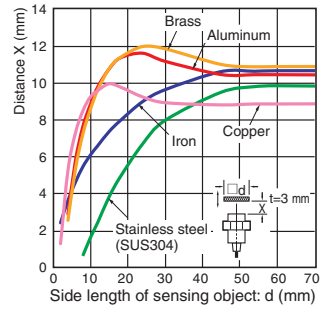

Size: M30
 E2EW-(Q)X20□30

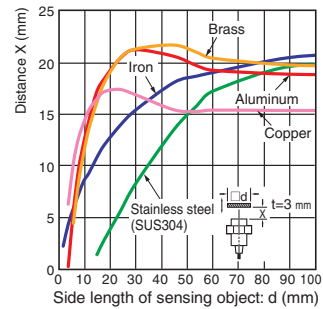

Influence of Sensing Object Thickness and Material

BASIC Model

**DC 2-wire/DC 3-wire
Double distance model/
Spatter-resistant
Double distance model**

Size: M12
E2EW-(Q)X3□12

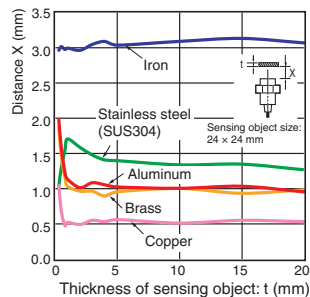

Size: M18
E2EW-(Q)X7□18

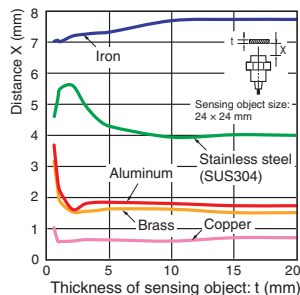

Size: M30
E2EW-(Q)X12□30

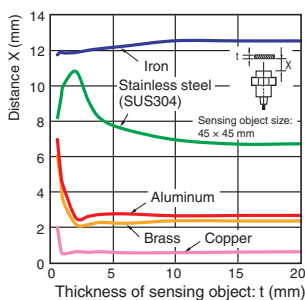

**DC 2-wire/DC 3-wire
Single distance model/
Spatter-resistant
Single distance model**

Size: M12
E2EW-(Q)X2□12

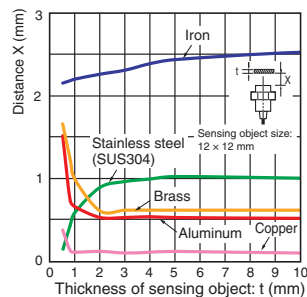

Size: M18
E2EW-(Q)X5□18

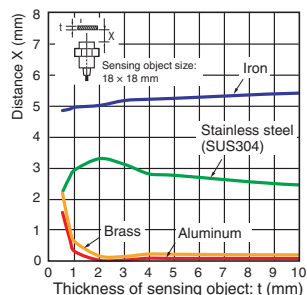

Size: M30
E2EW-(Q)X10□30

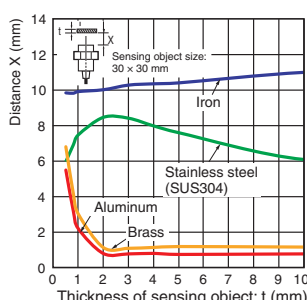

PREMIUM Model

**DC 3-wire
Quadruple distance model/
Spatter-resistant
Quadruple distance model**

Size: M12
E2EW-(Q)X7□12

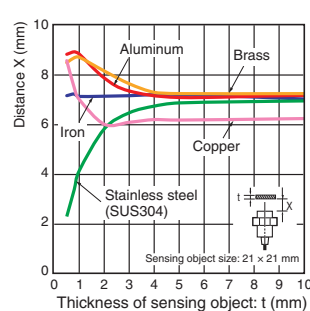

Size: M18
E2EW-(Q)X12□18

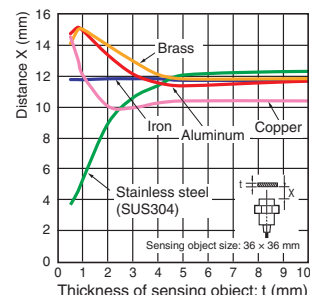

Size: M30
E2EW-(Q)X22□30

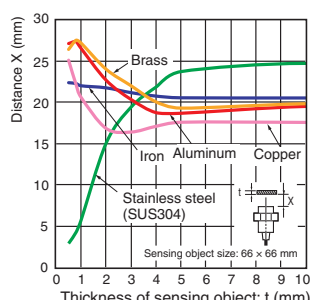

**DC 3-wire
Triple distance model/
Spatter-resistant
Triple distance model**

Size: M12
E2EW-(Q)X6□12

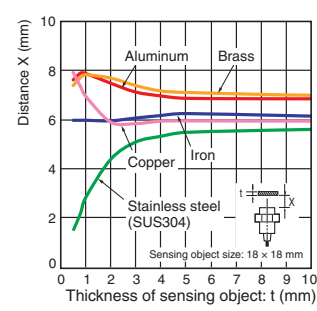

Size: M18
E2EW-(Q)X10□18

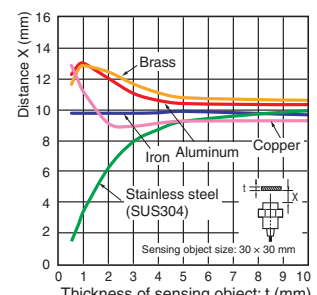

Size: M30
E2EW-(Q)X20□30

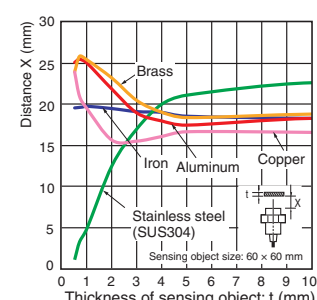

E2EW Series

E2EF/E2FM Series

E2EQ NEXT Series

E2EQ Series

XS5 Series

E2EW Series

Monitor Output vs. Sensing Distance

PREMIUM Model

DC 3-wire

Quadruple distance model/Spatter-resistant Quadruple distance model

Size: M12
E2EW-(Q)X7□12

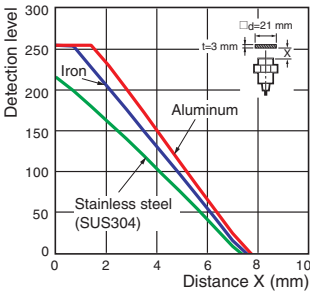

Size: M18
E2EW-(Q)X12□18

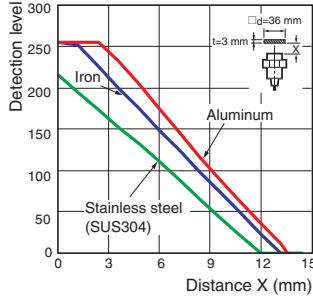

Size: M30
E2EW-(Q)X22□30

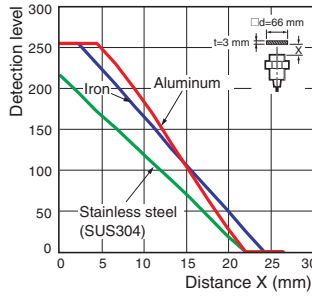

DC 3-wire

Triple distance model/Spatter-resistant Triple distance model

Size: M12
E2EW-(Q)X6□12

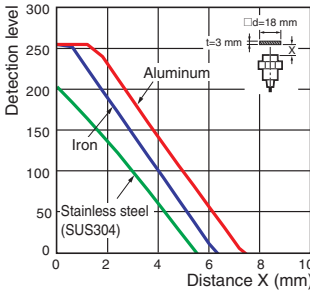

Size: M18
E2EW-(Q)X10□18

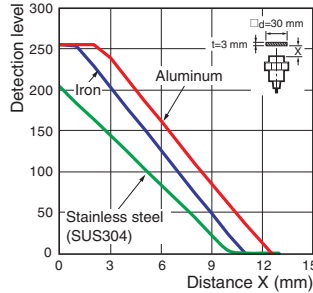

Size: M30
E2EW-(Q)X20□30

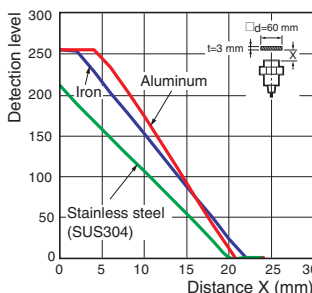

I/O Circuit Diagrams/Timing charts

DC 2-wire

BASIC Models

Operation mode	Model	Timing chart	Output circuit
NO	E2EW-(Q)X□D1□	<p>Setting indicator (green) Operation indicator (orange) Control output</p>	<p>Connector Pin Arrangement: (1) Brown, (2) Blue, (3) 0V, (4) Load</p> <p>Note: Pins 2 and 3 are not used.</p>
	E2EW-(Q)X□D1□-T	<p>Note 1. The load can be connected to either the +V or 0V side. 2. The E2E-X□D1-M1J-T has no polarity. Therefore, terminals 3 and 4 have no polarity.</p>	<p>Connector Pin Arrangement: (1) Brown, (2) Blue, (3) 0V, (4) Load</p> <p>Note: Pins 1 and 2 are not used.</p>
NC	E2EW-(Q)X□D2□	<p>Setting indicator (green) Operation indicator (orange) Control output</p>	<p>Connector Pin Arrangement: (1) Brown, (2) Blue, (3) 0V, (4) Load</p> <p>Note: Pins 3 and 4 are not used.</p>

DC 3-wire

PNP output (BASIC Model)

Operation mode	Model	Timing chart	Output circuit
NO	E2EW-(Q)X□B1		
NC	E2EW-(Q)X□B2		
NO+NC	E2EW-(Q)X□B3		

NPN output (BASIC Model)

Operation mode	Model	Timing chart	Output circuit
NO	E2EW-(Q)X□C1		
NC	E2EW-(Q)X□C2		
NO+NC	E2EW-(Q)X□C3		

Connector Pin Arrangement

M12 Connector M12 Smartclick Connector	
---	--

E2EW Series

E2EF/E2FM Series

E2EQ NEXT Series

E2EQ Series

X55 Series

E2EW Series

DC 3-wire

PNP output (PREMIUM Model) [Refer to *Timing Chart* on page 33]

Operation mode	Model	Output circuit	
		Standard I/O mode (SIO mode) When using as a general	IO-Link Communication mode (COM mode) When using the Sensor connected to IO-Link Master Unit
NO	E2EW-(Q)X□B1		
NC	E2EW-(Q)X□B2		---
NO+NC	E2EW-(Q)X□B3		

In the IO-Link mode, the cord between the IO-Link master and sensor must have a length of 20 m or less.

NPN output (PREMIUM Model)

Operation mode	Model	Timing chart	Output circuit
NO	E2EW-(Q)X□C1		
NC	E2EW-(Q)X□C2		
NO+NC	E2EW-(Q)X□C3		

Connector Pin Arrangement

M12 Connector M12 Smartclick Connector	
---	--

DC 3-wire

PNP output (PREMIUM Model)

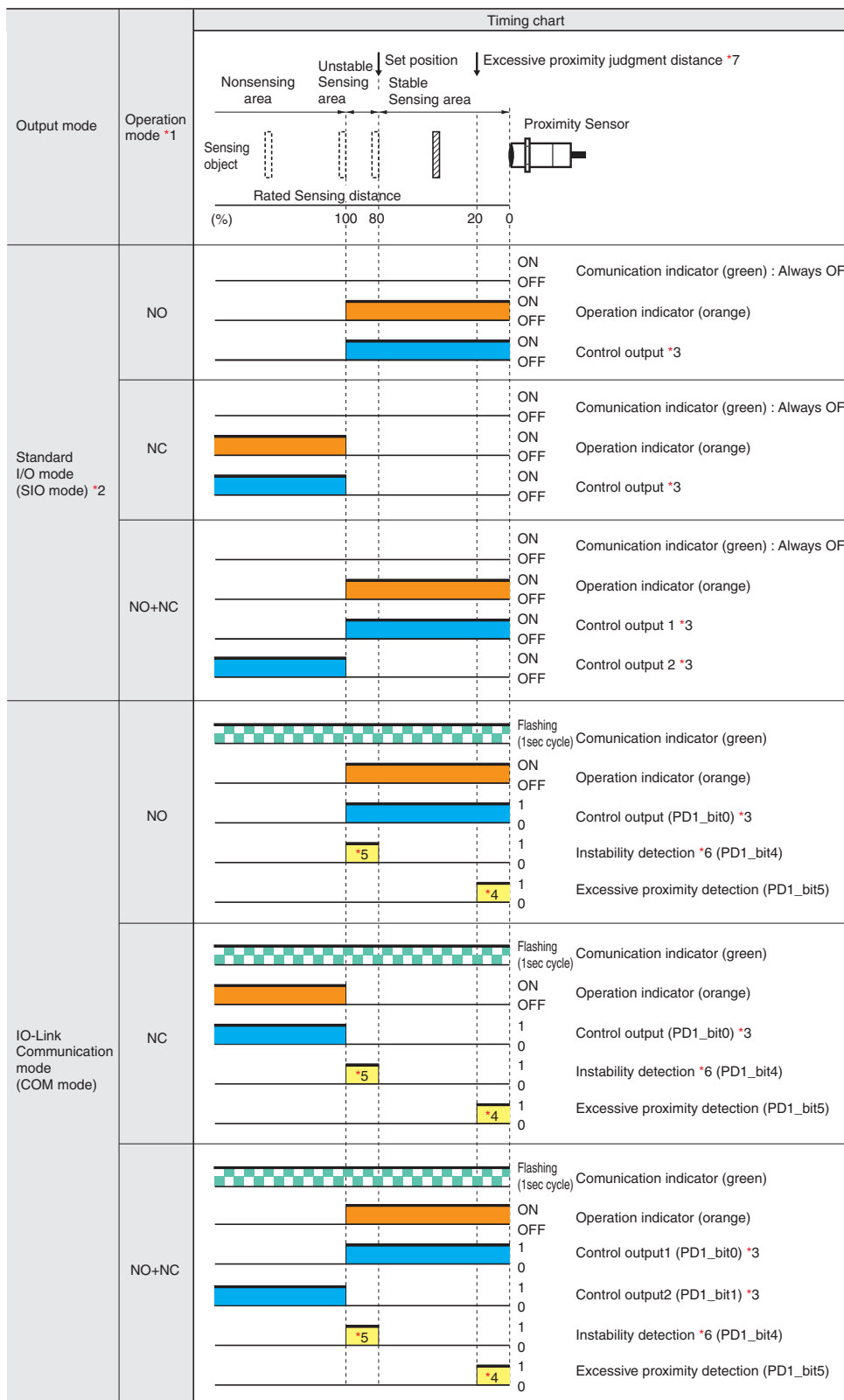

*3. The timer function of the control output can be set up by the IO-Link communications. (It is able to select ON delay, OFF delay, one-shot, or ONOFF delay function and select a timer time of 1 to 16,383ms (T).)

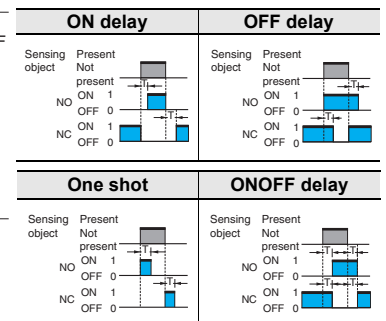

*4. The excessive proximity diagnosis function can be selected by the IO-Link communications.

*5. The instability detection diagnosis can be selected by the IO-Link communications.

*6. The judgment time for the instability detection diagnosis can be selected by the IO-Link communications. (For the ON delay timer function, the setting can be selected from 0 (invalid), 10, 50, 100, 300, 500, or 1000 ms.)

*7. The judgment distance of the excessive proximity diagnosis function can be selected by the IO-Link communications. (The distance can be selected as a combination of the material of the object detected, such as iron, aluminum, or SUS and the judgment distance of approximately 10, 20, or 30%. However, it is not allowed to select a combination of aluminum and 10%.)

Please contact your OMRON sales representative regarding the IO-Link setup file (IODD file).

Please contact your OMRON sales representative regarding assignment of data.

*1. For models with IO-Link, the operation mode can be changed by the IO-Link communications.

*2. If using a model with IO-Link as a general sensor or using a model without IO-Link, it operates in the standard I/O mode (SIO mode).

Safety Precautions

Be sure to read the precautions for all models in the website at: <http://www.ia.omron.com/>.

Warning Indications

⚠ WARNING	Warning level Indicates a potentially hazardous situation which, if not avoided, will result in minor or moderate injury, or may result in serious injury or death. Additionally there may be significant property damage.
Precautions for Safe Use	Supplementary comments on what to do or avoid doing, to use the product safely.
Precautions for Correct Use	Supplementary comments on what to do or avoid doing, to prevent failure to operate, malfunction or undesirable effect on product performance.

Meaning of Product Safety Symbols

	General prohibition Indicates the instructions of unspecified prohibited action.
	Caution, explosion Indicates the possibility of explosion under specific conditions.

⚠ WARNING

This product is not designed or rated for ensuring safety of persons either directly or indirectly. Do not use it for such purposes.

Otherwise, explosion may result. Never use the product with an AC power supply.

Precautions for Safe Use

The following precautions must be observed to ensure safe operation.

- Do not use the product in environments subject to flammable or explosive gases.
- Do not attempt to disassemble, repair, or modify the product.
- Do not use a voltage that exceeds the rated operating voltage range.
Applying a voltage that is higher than the operating voltage range may result in explosion or fire.
- Be sure that the power supply polarity and other wiring is correct. Incorrect wiring may cause explosion or fire.
- If the power supply is connected directly without a load, the internal elements may explode or burn.
- Dispose of the product according to applicable regulations (laws).

Precautions for Correct Use

Do not use the product in any atmosphere or environment that exceeds the ratings.

Operating Environment

- Do not install the Sensor in the following locations.
 - Outdoor locations directly subject to sunlight, rain, snow, water droplets, or oil.
 - Locations subject to atmospheres with chemical vapors, in particular solvents and acids.
 - Locations subject to corrosive gases.
- The Sensor may malfunction if used near ultrasonic cleaning equipment, high-frequency equipment, transceivers, cellular phones, inverters, or other devices that generate a high-frequency electric field. Please refer to the Precautions for Correct Use on the OMRON website (www.ia.omron.com) for typical measures.
- Laying the Proximity Sensor wiring in the same conduit or duct as high-voltage wires or power lines may result in incorrect operation and damage due to induction. Wire the Sensor using a separate conduit or independent conduit.
- Never use thinner or other solvents. Otherwise, the Sensor surface may be dissolved.
- When turning on the power by influence of temperature environment, an output mis-pulse sometimes occurs. After the sensor has passed for 300 msec after turning on, please use in the stable state.
- The sensor is adjusted with a high degree of accuracy, so do not use in the environment with sudden temperature change.
- Operation check is performed using an OMRON's IO-Link master. If using an IO-Link master from another company, perform the operation check in advance. (Models with IO-Link only.)
- When connecting non IO-Link compliant models to the IO-Link master, use the SIO mode.
- In the IO-Link mode, the cord between the IO-Link master and sensor must have a length of 20 m or less. (Models with IO-Link only.)
- The Sensor cannot be used embedded in where pressure is constantly applied to the sensing surface, such as hydraulic cylinders and hydraulic valves.

AND Connection of Proximity Sensors (DC 2-wire)

Two or more sensors cannot be connected in series on the AND circuit. Use them via a relay as shown on the figure.

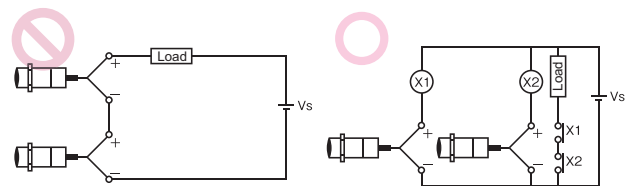

OR Wiring of Proximity Sensors (DC 2-wire)

As a general principle, two or more sensors cannot be used in parallel on the OR circuit. It is possible only when sensors do not operate simultaneously and loads do not need to be maintained. When loads need to be maintained, use the sensors via a relay as shown on the figure.

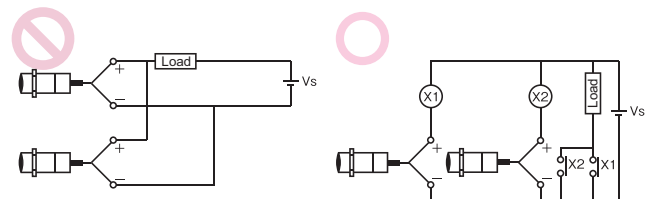

Design

Influence of Surrounding Metal

When mounting the Proximity Sensor, ensure that the minimum distances given in the following table are maintained. If you use a nut, only use the provided nut. And ensure that the minimum distances between the sensing surface and nut is bigger than the "L" given in the following table. Other non-ferrous metals affect sensor's performance in the same way as aluminum. Perform the operation check in advance.

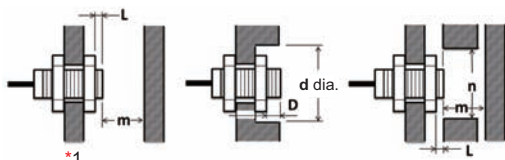

(Unit: mm)

Mounting panel material: Iron

Models	Model	L	d	D	m	n
Quadruple distance model	E2EW-(Q)X7□12	4	30	4	28	36
	E2EW-(Q)X12□18	6	54	6	36	54
	E2EW-(Q)X22□30	8	90	8	66	90
Triple distance model	E2EW-(Q)X6□12	4	30	4	24	36
	E2EW-(Q)X10□18	2	54	2	30	54
	E2EW-(Q)X20□30	0	30	0	60	90
Double distance model	E2EW-(Q)X3□12	0	12	0	12	40
	E2EW-(Q)X7□18	0	18	0	28	60
	E2EW-(Q)X12□30	0	30	0	48	100
Single distance model	E2EW-(Q)X2□12	0	12	0	8	40
	E2EW-(Q)X5□18	0	18	0	20	60
	E2EW-(Q)X10□30	0	30	0	40	100

Mounting panel material: Aluminum

Models	Model	L	d	D	m	n
Quadruple distance model	E2EW-(Q)X7□12	12	70	12	28	70
	E2EW-(Q)X12□18	12	80	12	36	80
	E2EW-(Q)X22□30 *1	16	120	16	66	120
Triple distance model	E2EW-(Q)X6□12	12	70	12	24	70
	E2EW-(Q)X10□18	12	80	12	30	80
	E2EW-(Q)X20□30 *1	16	120	16	60	120
Double distance model	E2EW-(Q)X3□12	12	70	12	12	70
	E2EW-(Q)X7□18	12	80	12	28	80
	E2EW-(Q)X12□30	16	120	16	48	120
Single distance model	E2EW-(Q)X2□12	12	70	12	8	70
	E2EW-(Q)X5□18	12	80	12	20	80
	E2EW-(Q)X10□30	16	120	16	40	120

*1. If you use the model E2EW-(Q)X22□30, or E2EW-(Q)X20□30, the panel thickness (t) is 3 mm or less.

When the Proximity Sensor is mounted in metal, ensure that the minimum distances given in the following table are maintained.

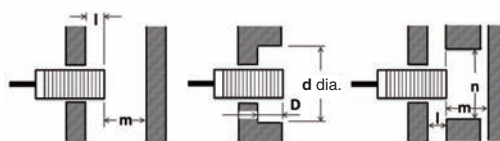

(Unit: mm)

Embedded material: Iron

Models	Model	l	d	D	m	n
Quadruple distance model	E2EW-(Q)X7□12	4	30	4	28	36
	E2EW-(Q)X12□18	6	54	6	36	54
	E2EW-(Q)X22□30	8	90	8	66	90
Triple distance model	E2EW-(Q)X6□12	0 *2	12 *2	0 *2	24	36
	E2EW-(Q)X10□18	0	18	0	30	54
	E2EW-(Q)X20□30	0	30	0	60	90
Double distance model	E2EW-(Q)X3□12	0	12	0	12	40
	E2EW-(Q)X7□18	0	18	0	28	60
	E2EW-(Q)X12□30	0	30	0	48	100
Single distance model	E2EW-(Q)X2□12	0	12	0	8	40
	E2EW-(Q)X5□18	0	18	0	20	60
	E2EW-(Q)X10□30	0	30	0	40	100

*2. If the thickness of the mounting bracket (t) is less than 10 mm, be sure to install the Sensor so that $l \geq 2$, $d \text{ (dia.)} \geq 30$, and $D \geq 2$.

Embedded material: Aluminum

Models	Model	l	d	D	m	n
Quadruple distance model	E2EW-(Q)X7□12	12	70	12	28	70
	E2EW-(Q)X12□18	12	80	12	36	80
	E2EW-(Q)X22□30	16	120	16	66	120
Triple distance model	E2EW-(Q)X6□12	12	70	12	24	70
	E2EW-(Q)X10□18	12	80	12	30	80
	E2EW-(Q)X20□30	16	120	16	60	120
Double distance model	E2EW-(Q)X3□12	12	70	12	12	70
	E2EW-(Q)X7□18	12	80	12	28	80
	E2EW-(Q)X12□30	16	120	16	48	120
Single distance model	E2EW-(Q)X2□12	12	70	12	8	70
	E2EW-(Q)X5□18	12	80	12	20	80
	E2EW-(Q)X10□30	16	120	16	40	120

Mutual Interference

When installing two or more Proximity Sensors face-to-face or side-by-side, ensure that the minimum distances given in the following table are maintained.

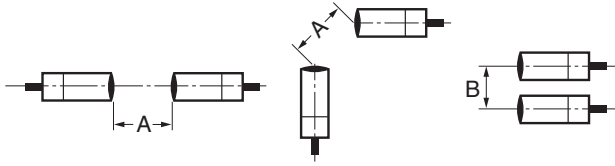

(Unit: mm)

Models	Model	Item	
		A	B
Quadruple distance model	E2EW-(Q)X7□12	45	40
	E2EW-(Q)X12□18	80	60
	E2EW-(Q)X22□30	135	110
Triple distance model	E2EW-(Q)X6□12	45	40
	E2EW-(Q)X10□18	80	60
	E2EW-(Q)X20□30	135	110
Double distance model	E2EW-(Q)X3□12	40	35
	E2EW-(Q)X7□18	65	60
	E2EW-(Q)X12□30	110	100
Single distance model	E2EW-(Q)X2□12	40	35
	E2EW-(Q)X5□18	65	60
	E2EW-(Q)X10□30	110	100

Chips from Cutting Aluminum

Normally, chips from cutting aluminum will not cause a detection signal to be output even if it adheres to or accumulates on the detection surface. In the following cases, however, a detection signal may be output.

Remove the cutting chips in these cases.

1. If $d \geq 2/3D$ at the center of the detection surface where d is the cutting chip size and D is the detection surface size

(Unit: mm)

Model	Dimension	D
E2EW-(Q)X□12		10
E2EW-(Q)X□18		16
E2EW-(Q)X□30		28

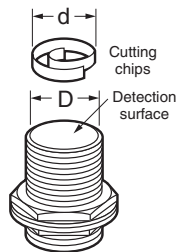

2. If the cutting chips are pressed down

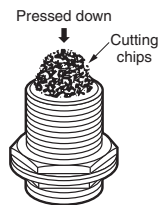

Mounting

Tightening Force

Do not tighten the nut with excessive force.

A washer must be used with the nut.

The tightening force must be the same or less than the figures in the following table.



Quadruple distance model, Triple distance model (Unit: N·m)

Size	Torque
M12	20 (15)
M18	70 (35)
M30	180 (60)

* Tighten the nut of the E2EW-Q to a torque in parentheses.

Double distance model, Single distance model (Unit: N·m)

Size	Torque
M12	30 (15)
M18	70 (35)
M30	180 (60)

* Tighten the nut of the E2EW-Q to a torque in parentheses.

Note: When mounting the Proximity Sensor, only use the provided nut. Do not use set screws. The Sensor may malfunction.

Dimensions

Sensors

BASIC Model DC 2-wire/DC 3-wire

E2EW/E2EW-Q Series (Double distance model/Spatter-resistant Double distance model/Single distance model/Spatter-resistant Single distance model)

Pre-wired Model/ Pre-wired Connector Model

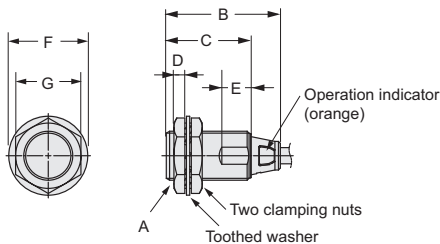

Pre-wired Model

Pre-wired Connector Model (M1TJ/M1TGJ)



(Operation mode): Output configuration (D1): NO
(D2): NC

Vinyl-insulated round cable with 2 conductors size: 6-dia.
(Conductor cross section: 0.5 mm² (AWG20), Insulator diameter: 1.5 mm),
Standard length: 2 m (Pre-wired Model), 0.3 m (Pre-wired Connector Model)

(Operation mode): Output configuration (B1/C1): NO
(B2/C2): NC

Vinyl-insulated round cable with 3 conductors size: 6-dia.
(Conductor cross section: 0.2 mm² (AWG24), Insulator diameter: 1.05 mm),
Standard length: 2 m (Pre-wired Model), 0.3 m (Pre-wired Connector Model)

(Operation mode): Output configuration (B3/C3): NO+NC

Vinyl-insulated round cable with 4 conductors size: 6-dia.
(Conductor cross section: 0.2 mm² (AWG24), Insulator diameter: 1.05 mm),
Standard length: 2 m (Pre-wired Model), 0.3 m (Pre-wired Connector Model)

Models	Model	A	B	C	D	E	F	G	
Double distance model	E2EW-(Q)X3 □12(-M1TJ) E2EW-(Q)X3D □12(-M1TGJ)	M12×P1	41.5	30	4	10	21 dia.	17	
	E2EW-(Q)X7 □18(-M1TJ) E2EW-(Q)X7D □18(-M1TGJ)	M18×P1	41.5	30	4	13	29 dia.	24	
	E2EW-(Q)X12 □30(-M1TJ) E2EW-(Q)X12D □30(-M1TGJ)	M30×P1.5	41.5	30	5	13	42 dia.	36	
	Single distance model	E2EW-(Q)X2 □12(-M1TJ) E2EW-(Q)X2D □12(-M1TGJ)	M12×P1	41.9	30.4	4	7	21 dia.	17
		E2EW-(Q)X5 □18(-M1TJ) E2EW-(Q)X5D □18(-M1TGJ)	M18×P1	41.9	30.4	4	10	29 dia.	24
		E2EW-(Q)X10 □30(-M1TJ) E2EW-(Q)X10D □30(-M1TGJ)	M30×P1.5	41.8	30.3	5	10	42 dia.	36

M12 Connector Model

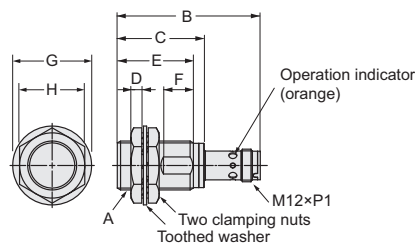

Models	Model	A	B	C	D	E	F	G	H
Single distance model	E2EW-X2□12-M1	M12×P1	54.8	---	4	28	6	21 dia.	17
	E2EW-X5□18-M1	M18×P1	54.8	32.4	4	28	9	29 dia.	24
	E2EW-X10□30-M1	M30×P1.5	54.7	32.3	5	28	9	42 dia.	36

Mounting Hole Dimensions

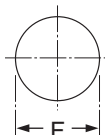

Dimensions	F (mm)
M12	12.5 dia. ^{+0.5} / ₀
M18	18.5 dia. ^{+0.5} / ₀
M30	30.5 dia. ^{+0.5} / ₀

Angle R of the Bending Wire

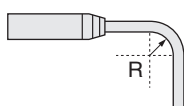

Dimensions	R (mm)
M12	18
M18	
M30	

E2EW Series

Dimensions

(Unit: mm)

Tolerance class IT16 applies to dimensions in this data sheet unless otherwise specified.

Sensors

PREMIUM Model DC 3-wire

E2EW/E2EW-Q Series (Quadruple distance/Triple distance/ Spatter-resistant Quadruple distance, Spatter-resistant Triple distance model)

Pre-wired Model/ Pre-wired Connector Model

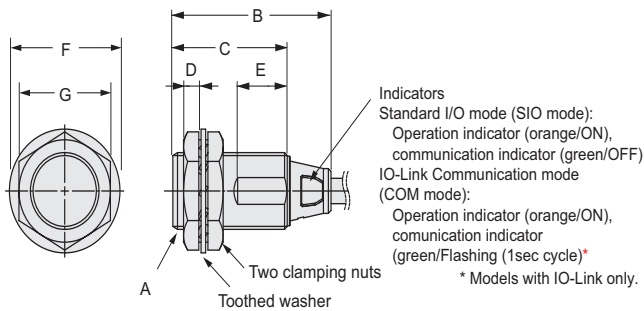

Pre-wired Model

Pre-wired Connector Model (M1TJ)

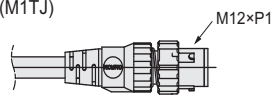

(Operation mode): Output configuration (B1, C1): NO,
(B2, C2): NC
Vinyl-insulated round cable with 3 conductors size: 6-dia.
(Conductor cross section: 0.2 mm² (AWG24), Insulator diameter: 1.05 mm),
Standard length: 2 m (Pre-wired Model), 0.3 m (Pre-wired Connector Model)

(Operation mode): Output configuration (B3, C3): NO+NC
Vinyl-insulated round cable with 4 conductors size: 6-dia.
(Conductor cross section: 0.2 mm² (AWG24), Insulator diameter: 1.05 mm),
Standard length: 2 m (Pre-wired Model), 0.3 m (Pre-wired Connector Model)

Models	Model	A	B	C	D	E	F	G
Quadruple distance model	E2EW-(Q)X7 □12(-M1TJ)	M12×P1	41.5	30	4	10	21 dia.	17
	E2EW-(Q)X12 □18(-M1TJ)	M18×P1	41.5	30	4	13	29 dia.	24
	E2EW-(Q)X22 □30(-M1TJ)	M30×P1.5	41.5	30	5	13	42 dia.	36
Triple distance model	E2EW-(Q)X6 □12(-M1TJ)	M12×P1	41.5	30	4	10	21 dia.	17
	E2EW-(Q)X10 □18(-M1TJ)	M18×P1	41.5	30	4	13	29 dia.	24
	E2EW-(Q)X20 □30(-M1TJ)	M30×P1.5	41.5	30	5	13	42 dia.	36

M12 Connector Model

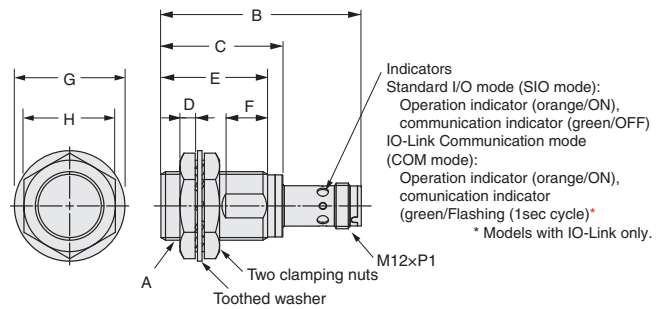

Models	Model	A	B	C	D	E	F	G	H
Quadruple distance model	E2EW-(Q)X7 □12-M1	M12×P1	54.4	---	4	28	8	21 dia.	17
	E2EW-(Q)X12 □18-M1	M18×P1	54.4	32	4	28	11	29 dia.	24
	E2EW-(Q)X22 □30-M1	M30×P1.5	54.4	32	5	28	11	42 dia.	36
Triple distance model	E2EW-(Q)X6 □12-M1	M12×P1	54.4	---	4	28	8	21 dia.	17
	E2EW-(Q)X10 □18-M1	M18×P1	54.4	32	4	28	11	29 dia.	24
	E2EW-(Q)X20 □30-M1	M30×P1.5	54.4	32	5	28	11	42 dia.	36

Mounting Hole Dimensions

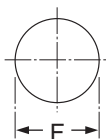

Dimensions	F (mm)
M12	12.5 dia. ^{+0.5} / ₀
M18	18.5 dia. ^{+0.5} / ₀
M30	30.5 dia. ^{+0.5} / ₀

Angle R of the Bending Wire

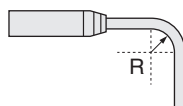

Dimensions	R (mm)
M12	18
M18	
M30	

E2EF/E2FM

DC 2-wire/DC 3-wire

Metal Head that Withstands Harsh Environments Where the Workpiece Can Rub against the Sensor

- Completely stainless-steel housing
- Spatter-resistant Models with fluororesin coating are available.
- Aluminum chip immunity
- Pre-wired Smartclick Connector Models are also available.

 Be sure to read *Safety Precautions* on page 43.

Note: Models with a fluororesin coating also use vinyl chloride for the cable material and require separate protection.



Ordering Information

E2EF Series

DC 2-wire [Refer to *Ratings and Specification* on page 40, *Dimensions* on page 44.]

Size (Sensing distance)	Connection method	Polarity	Model
			Operation mode: NO
M8 (2 mm)	Pre-wired (2 m)	Yes	E2EF-X2D1 2M
	M12 Pre-wired Smartclick Connector (0.3 m)	Yes	E2EF-X2D1-M1TGJ 0.3M

DC 2-wire [Refer to *Ratings and Specification* on page 40, *Dimensions* on page 44.]

Spatter-resistant Models

Size (Sensing distance)	Connection method	Polarity	Model
			Operation mode: NO
M8 (2 mm)	Pre-wired (2 m) *1	Yes	E2EF-QX2D1 2M
	M12 Pre-wired Smartclick Connector (0.3 m)	Yes	E2EF-QX2D1-M1TGJ 0.3M

*1. Vinyl chloride is used for the cable material, and separate protection is required.

E2FM Series

DC 2-wire [Refer to *Ratings and Specification* on page 40, *Dimensions* on page 44.]

Size (Sensing distance)	Connection method	Polarity	Model
			Operation mode: NO *1
M8 (1.5 mm)	Pre-wired (2 m)	Yes	E2FM-X1R5D1 2M *2
	M12 Pre-wired Smartclick Connector (0.3 m)	Yes	E2FM-X1R5D1-M1TGJ 0.3M

DC 3-wire [Refer to *Ratings and Specification* on page 40, *Dimensions* on page 44.]

Size (Sensing distance)	Connection method *3	Model	
		PNP, Operation mode: NO *1	NPN, Operation mode: NO *1
M8 (1.5 mm)	Pre-wired (2 m)	E2FM-X1R5B1 2M	E2FM-X1R5C1 2M

*1. NC models are also available. Ask your OMRON representative for details.

*2. Fluororesin coating models are also available. The model number is E2FM-QX□D1. The cable material, however, is vinyl chloride and requires separate protection.

*3. M12 Connector Models are also available with "M1" suffix. (Example: E2FM-X1R5C1-M1E)

Sensor I/O Connectors (Sold Separately)

For details of the connector, refer to XS5 Series on page 70.

E2EF/E2FM

Ratings and Specifications

Item	Size Output Exterior Model	M8			
		DC 2-wire			DC 3-wire
		Completely stainless-steel housing	Fluororesin coating	Completely stainless-steel housing	Completely stainless-steel housing
		E2EF-X2D1(-M1TGJ)	E2EF-QX2D1(-M1TGJ)	E2FM-X1R5D1(-M1TGJ)	E2FM-X1R5□
Sensing distance	2 mm ±10%		1.5 mm ±10%		
Set distance	0 to 1.4 mm		0 to 1.05 mm		
Differential travel	15% max. of sensing distance				
Sensing object	Ferrous metal (The sensing distance decreases with non-ferrous metal. Refer to <i>Engineering Data</i> on page 42.)				
Standard sensing object (Iron)	12 × 12 × 1 mm		8 × 8 × 1 mm		
Response frequency *1	200 Hz				
Power supply voltage	10 to 30 VDC, ripple (p-p): 10% max.		12 to 24 VDC (10 to 30 VDC), ripple (p-p): 10% max.		
Leakage current	0.8 mA max.			---	
Current consumption	---			10 mA max.	
Polarity	Yes			---	
Control output	Switching capacity	3 to 100 mA		200 mA max.	
	Residual voltage	3 V max. (Load current: 100 mA max., Cable length: 2 m)		2 V max. (Load current: 200 mA, Cable length: 2 m)	
Indicators	Operation indicator (red LED), Setting indicator (green LED)			Operation indicator (yellow LED)	
Operation mode (with sensing object approaching)	NO (normally open)			C1: NPN open collector, NO (normally open) *2 B1: PNP open collector, NO (normally open) *2	
Protection circuits	Surge suppressor, Load short-circuit protection			Reversed power supply polarity protection, Surge suppressor, Load short-circuit protection, and Reversed output polarity protection *3	
Ambient temperature range	Operating: -10 to 70°C, Storage: -25 to 70°C (with no icing or condensation)		Operating: -25 to 70°C, Storage: -25 to 70°C (with no icing or condensation)		
Ambient humidity range	Operating/Storage: 35% to 95% (with no condensation)				
Temperature influence	±20% max. of sensing distance at 23°C in the temperature range of -10 to 70°C.		±20% max. of sensing distance at 23°C in the temperature range of -25 to 70°C.		
Voltage influence	±1% max. of sensing distance at rated voltage in the rated voltage ±15% range				
Insulation resistance	50 MΩ min. (at 500 VDC) between current-carrying parts and case				
Dielectric strength	1,000 VAC, 50/60 Hz for 1 minute between current-carrying parts and case				
Vibration resistance	Destruction: 10 to 55 Hz, 1.5-mm double amplitude for 2 hours each in X, Y, and Z directions				
Shock resistance	Destruction: 500 m/s ² 10 times each in X, Y, and Z directions				
Degree of protection	IEC 60529 IP67				
Connection method	Pre-wired Models (Standard cable length: 2 m) Pre-wired Connector Models (Standard cable length: 300 mm)			Pre-wired Models (Standard cable length: 2 m)	
Weight (packed state)	Pre-wired	Approx. 105 g			
	Pre-wired M12 Connector	Approx. 65 g		---	
Materials	Case	Stainless steel (SUS303) (E2EF-QX□D: SUS303, with fluororesin coating)			
	Sensing surface (thickness)	Stainless steel (SUS303) (E2EF-QX□D: SUS303, with fluororesin coating)		(0.4 mm)	
		(0.2 mm)			
	Clamping nuts	Stainless steel (SUS303) (E2EF-QX□D: SUS303, with fluororesin coating)			
	Toothed washer	Zinc-plated iron			
Cable	PVC (flame retardant)				
Accessories	Instruction manual				

*1. The response frequency of the DC switching section is an average value. Measurement conditions are as follows: standard sensing object, a distance of twice the standard sensing object, and a set distance of half the sensing distance.

*2. NC (normally closed) models are also available. Contact your OMRON representative.

*3. Except the E2FM-X1R5B1-M1.

I/O Circuit Diagrams

DC 2-wire
E2EF/E2FM

Operation mode	Model	Timing chart	Output circuit
NO	E2EF-(Q)X□D1(-M1TGJ) E2FM-X□D1(-M1TGJ)		<p>Note: The load can be connected to either the +V or 0 V side.</p> <p>< -M1TGJ > Connector Pin Arrangement</p> <p>Note: Pins 2 and 3 are not used.</p>

DC 3-wire
E2FM

Operation mode	Output configuration	Model	Timing chart	Output circuit
NO	NPN open collector model	E2FM-X1R5C□		<p>* There is no reversed output polarity protection diode.</p> <p>Connector Pin Arrangement</p> <p>Note: For Connector Models, the connection between pins 1, 4 and 3 uses an NO contact, and the connection between pins 1, 2 and 3 uses an NC contact.</p>
	PNP open collector model	E2FM-X1R5B□		<p>* There is no reversed output polarity protection diode.</p> <p>Connector Pin Arrangement</p> <p>Note: For Connector Models, the connection between pins 1, 4 and 3 uses an NO contact, and the connection between pins 1, 2 and 3 uses an NC contact.</p>

E2EF Series

E2EF/E2FM Series

E2EQ NEXT Series

E2EQ Series

X55 Series

E2EF/E2FM

Engineering Data (Reference Value)

Sensing Area

E2EF-(Q)X2D1
E2FM-X1R5□

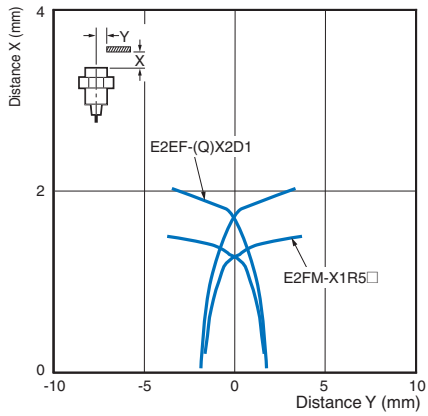

Influence of Sensing Object Size and Material

E2EF-(Q)X2D1

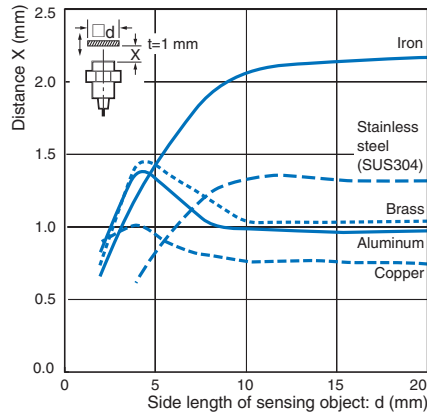

E2FM-X1R5□

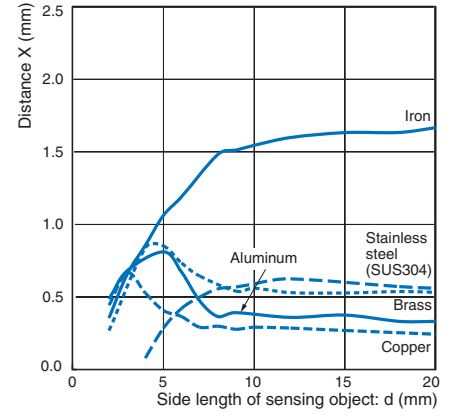

Leakage Current

E2EF-(Q)X2D1
E2FM-X1R5D1

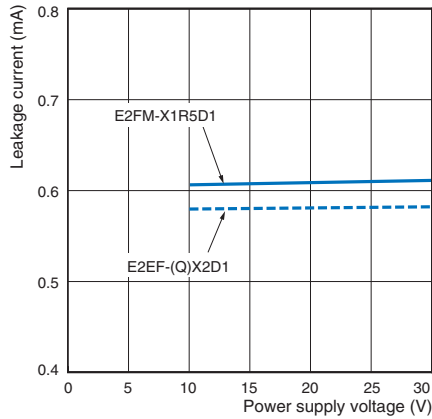

Residual Output Voltage

E2EF-(Q)X2D1
E2FM-X1R5D1

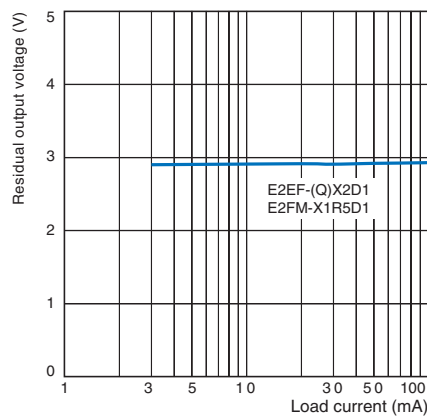

E2FM-X1R5□

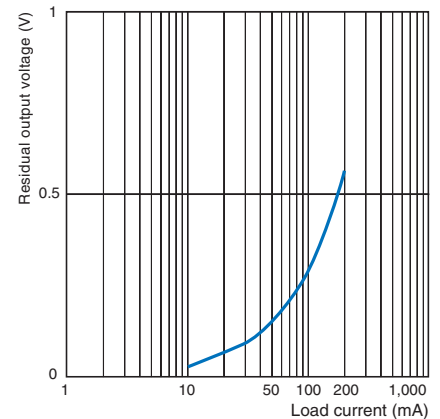



Safety Precautions

Be sure to read the precautions for all models in the website at: <http://www.ia.omron.com/>.

Warning Indications

 WARNING	Warning level Indicates a potentially hazardous situation which, if not avoided, will result in minor or moderate injury, or may result in serious injury or death. Additionally there may be significant property damage.
Precautions for Safe Use	Supplementary comments on what to do or avoid doing, to use the product safely.
Precautions for Correct Use	Supplementary comments on what to do or avoid doing, to prevent failure to operate, malfunction or undesirable effect on product performance.

Meaning of Product Safety Symbols

	General prohibition Indicates the instructions of unspecified prohibited action.
	Caution, explosion Indicates the possibility of explosion under specific conditions.

WARNING

This product is not designed or rated for ensuring safety of persons either directly or indirectly. Do not use it for such purposes.

Otherwise, explosion may result. Never use the product with an AC power supply.

Precautions for Safe Use

- The following precautions must be observed to ensure safe operation.
- Do not use the Sensor in an environment where inflammable or explosive gas is present.
 - Do not attempt to disassemble, repair, or modify any Sensors.
 - Power Supply Voltage
Do not use a voltage that exceeds the rated operating voltage range. Applying a voltage that is higher than the operating voltage range may result in explosion or fire.
 - Incorrect Wiring
Be sure that the power supply polarity and other wiring is correct. Incorrect wiring may cause explosion or fire.
 - Connection without a Load
If the power supply is connected directly without a load, the internal elements may explode or burn. Be sure to insert a load when connecting the power supply.

Precautions for Correct Use

- Do not use the Sensor under ambient conditions that exceed the ratings.
- Do not use the Sensor in the following locations.
 - Outdoor locations directly subject to sunlight, rain, snow, or water droplets
 - Locations subject to atmospheres with chemical vapors, in particular solvents and acids
 - Locations subject to corrosive gas
 - The Sensor may malfunction if used near ultrasonic cleaning equipment, high-frequency equipment, transceivers, cellular phones, inverters, or other devices that generate a high-frequency electric field. Refer to the OMRON website (www.ia.omron.com/) for typical measures.
 - Laying the Sensor wiring in the same conduit or duct as high-voltage wires or power lines may result in incorrect operation and damage due to induction. Wire the Sensor using a separate conduit or independent conduit.
 - Cleaning
Never use thinner or other solvents. Otherwise, the Sensor surface may be dissolved.
 - The Sensor cannot be used embedded in where pressure is constantly applied to the sensing surface, such as hydraulic cylinders and hydraulic valves.

Design

Influence of Surrounding Metal

When the Proximity Sensor is embedded in metal, make sure that the clearances given in the following table are maintained. The values depend on the type of nuts used for mounting. Be sure to use the supplied nuts (SUS303).

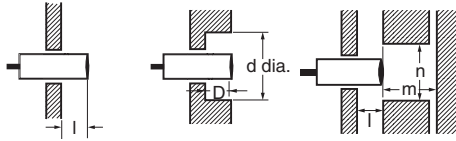

(Unit: mm)

Model	Item Embedding material	l	d	D	m	n
		E2EF-(Q)X2D1	Iron	0	8	0
	Aluminum	10	50	10	8	50
E2FM-X1R5□	Iron	0	8	0	4.5	30
	Aluminum	10	50	10	4.5	50

Note: The influence from other non-magnetic surrounding metals is nearly the same as that from aluminum.

Mutual Interference

When installing two or more Sensors face-to-face or side-by-side, ensure that the minimum distances given in the following table are maintained.

(Unit: mm)

Model	Item	A	B
E2EF-(Q)X2D1		35	35
E2FM-X1R5□		35	30

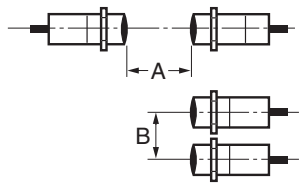

E2EW Series

E2EF/E2FM Series

E2EQ NEXT Series

E2EQ Series

X55 Series

E2EF/E2FM

Chips from Cutting Aluminum

Normally, chips from cutting aluminum will not cause a detection signal to be output even if it adheres to or accumulates on the detection surface. In the following cases, however, a detection signal may be output. Remove the cutting chips in these cases.

1. If $d \geq \frac{2}{3} D$ at the center of the detection surface where d is the cutting chip size and D is the detection surface size

(Unit: mm)

Model	Dimension	D
E2EF-(Q)X2D1		6
E2FM-X1R5□		

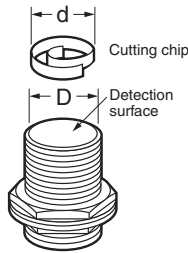

2. If the cutting chips are pressed down

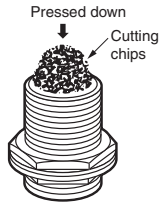

Mounting

Do not tighten the nut with excessive force. A washer must be used with the nut. Do not use tightening force that exceeds the values in the following table.

Model	Torque
E2EF-(Q)X2D1	9 N·m
E2FM-X1R5□	

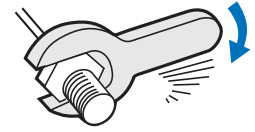

Dimensions

(Unit: mm)
Tolerance class IT16 applies to dimensions in this data sheet unless otherwise specified.

Sensors

E2EF

Pre-wired Models (DC 2-wire)

E2EF-X2D1 -QX2D1

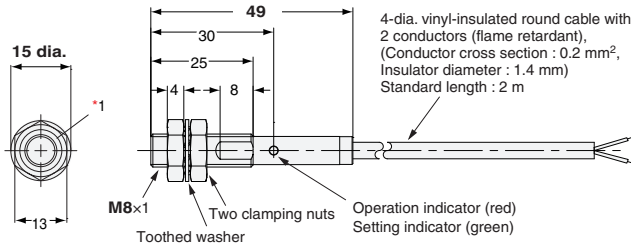

Smartclick Connector Models (DC 2-wire)

E2EF-X2D1-M1TGJ -QX2D1-M1TGJ

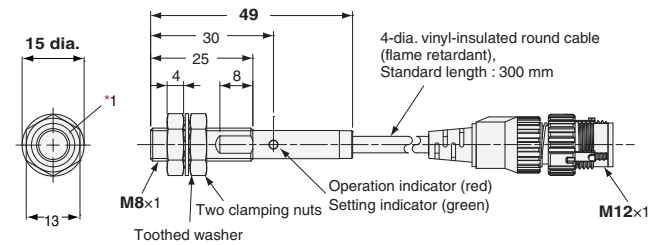

*1. The E2EF-QX□D type Clamping nut (optional accessory) is grooved to identify the material (SUS303, with fluororesin coating).

E2FM

Pre-wired Models (DC 2-wire/DC 3-wire)

E2FM-X1R5□

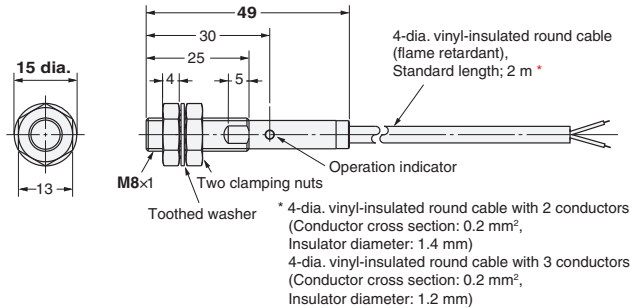

Pre-wired Connector Models (DC 2-wire)

E2FM-X1R5D□-M1TGJ

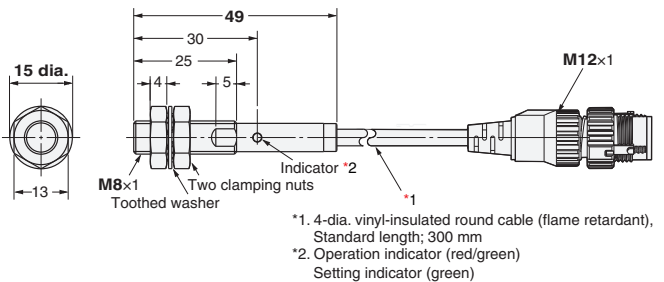

Enables easier and standardized designs previously not possible with fluororesin coating models

- Nearly double*¹ the sensing distance of previous
- With high-brightness LED, the indicator is visible anywhere from 360°
- Comes in a wide variation to make sensor selection easy
- UL certification (UL60947-5-2)*² and CSA certification (CSA C22.2 UL60947-5-2-14)

*1. Comparison with E2EQ products. Based on September 2021 OMRON investigation.

*2. M8 (4-pin) Connector Models are not UL certified.

 Be sure to read *Safety Precautions* on page 60.



For the most recent information on models that have been certified for safety standards, refer to your OMRON website.

E2EQ NEXT Series Model Number Legend

E2EQ - X (1) (2) (3) (4) (5) (6) - (7) - (8) (9)

No.	Type	Code	Meaning	Remarks
(1)	Sensing distance	Number	Sensing distance (Unit: mm) (R: Indication of decimal point)	
(2)	Output configuration	B	PNP open collector	Whether the D model has polarity is defined by number (7).
		C	NPN open collector	
		D	DC 2-wire polarity/no polarity	
(3)	Operation mode	1	Normally open (NO)	
		2	Normally closed (NC)	
		3	Normally open, Normally closed (NO+NC)	
(4)	IO-Link baud rate	Blank	Non IO-Link compliant	
		D	COM2 (38.4 kbps)	
		T	COM3 (230.4 kbps)	
(5)	Size	8	M8	
		12	M12	
		18	M18	
		30	M30	
(6)	Connection method	Blank	Pre-wired Models	
		M1	M12 Connector Models	
		M3	M8 (4-pin) Connector Models	
		M5	M8 (3-pin) Connector Models	
		M1GJ	M12 Pre-wired Standard Connector Models DC 2-wire	
		M1TGJ	M12 Pre-wired Smartclick Connector Models DC 2-wire	
		M1TGJR	M12 Pre-wired Smartclick Connector Models Robot (bending-resistant) cable DC 2-wire	
		M1TJ	M12 Pre-wired Smartclick Connector Models DC 3-wire	
M1TJR	M12 Pre-wired Smartclick Connector Models Robot (bending-resistant) cable DC 3-wire			
(7)	DC 2-wire polarity	Blank	Polarity	
		T	No polarity	
(8)	Cable specifications *1	Blank	Standard PVC cable	
		R	Robot (bending-resistant) cable	
(9)	Cable length	Number M	Cable length	

*1. (8) is only shown in the model number of Pre-wired Models.

Note: The purpose of this model number legend is to provide understanding of the meaning of specifications from the model number.

E2EQ NEXT Series

Ordering Information

Sensors

BASIC Model

E2EQ NEXT Series (Spatter-resistant Double distance model) *NEW*

DC 2-wire Shielded [Refer to *Ratings and Specification* on page 49, *Dimension* on page 62.]

Size (Sensing distance)	Connection method	Polarity	Model
			Operation mode: NO
M12 (4 mm)	Pre-wired (2 m) *1	NO	E2EQ-X4D112-T 2M
	M12 Pre-wired Smartclick Connector (0.3 m)		E2EQ-X4D112-M1TGJ-T 0.3M
M18 (8 mm)	Pre-wired (2 m) *1		E2EQ-X8D118-T 2M
	M12 Pre-wired Smartclick Connector (0.3 m)		E2EQ-X8D118-M1TGJ-T 0.3M
M30 (15 mm)	Pre-wired (2 m) *1		E2EQ-X15D130-T 2M
	M12 Pre-wired Smartclick Connector (0.3 m)		E2EQ-X15D130-M1TGJ-T 0.3M

*1. Models with 5-m cable length are also available (Example: E2EQ-X4D112-T 5M).

Sensors

BASIC Model

E2EQ NEXT Series (Spatter-resistant Double distance model)

DC 3-wire Shielded [Refer to Ratings and Specification on page 50, Dimension on page 62.]

Size (Sensing distance)	Connection method *2	Body size	Operation mode *3	Model	
				PNP	NPN
M8 (2 mm)	Pre-wired (2 m) *1	38 mm	NO	E2EQ-X2B1D8 2M	E2EQ-X2C18 2M
	M12 Pre-wired Smartclick Connector (0.3 m)	38 mm	NO	E2EQ-X2B1D8-M1TJ 0.3M	E2EQ-X2C18-M1TJ 0.3M
M12 (4 mm)	Pre-wired (2 m) *1	47 mm	NO	E2EQ-X4B1D12 2M	E2EQ-X4C112 2M
			NO+NC	E2EQ-X4B3D12 2M	E2EQ-X4C312 2M
	M12 Pre-wired Smartclick Connector (0.3 m)	47 mm	NO	E2EQ-X4B1D12-M1TJ 0.3M	E2EQ-X4C112-M1TJ 0.3M
			NO+NC	E2EQ-X4B3D12-M1TJ 0.3M	E2EQ-X4C312-M1TJ 0.3M
M18 (8 mm)	Pre-wired (2 m) *1	55 mm	NO	E2EQ-X8B1D18 2M	E2EQ-X8C118 2M
			NO+NC	E2EQ-X8B3D18 2M	E2EQ-X8C318 2M
	M12 Pre-wired Smartclick Connector (0.3 m)	55 mm	NO	E2EQ-X8B1D18-M1TJ 0.3M	E2EQ-X8C118-M1TJ 0.3M
			NO+NC	E2EQ-X8B3D18-M1TJ 0.3M	E2EQ-X8C318-M1TJ 0.3M
M30 (15 mm)	Pre-wired (2 m) *1	60 mm	NO	E2EQ-X15B1D30 2M	E2EQ-X15C130 2M
			NO+NC	E2EQ-X15B3D30 2M	E2EQ-X15C330 2M
	M12 Pre-wired Smartclick Connector (0.3 m)	60 mm	NO	E2EQ-X15B1D30-M1TJ 0.3M	E2EQ-X15C130-M1TJ 0.3M
			NO+NC	E2EQ-X15B3D30-M1TJ 0.3M	E2EQ-X15C330-M1TJ 0.3M

BASIC Model

E2EQ NEXT Series (Spatter-resistant Single distance model)

DC 3-wire Shielded [Refer to Ratings and Specification on page 50, Dimension on page 62.]

Size (Sensing distance)	Connection method *2	Body size	Operation mode *3	Model	
				PNP	NPN
M8 (1.5 mm)	Pre-wired (2 m) *1	38 mm	NO	E2EQ-X1R5B1D8 2M	E2EQ-X1R5C18 2M
	M12 Pre-wired Smartclick Connector (0.3 m)	38 mm	NO	E2EQ-X1R5B1D8-M1TJ 0.3M	E2EQ-X1R5C18-M1TJ 0.3M
M12 (2 mm)	Pre-wired (2 m) *1	47 mm	NO	E2EQ-X2B1D12 2M	E2EQ-X2C112 2M
			NO+NC	E2EQ-X2B3D12 2M	E2EQ-X2C312 2M
	M12 Pre-wired Smartclick Connector (0.3 m)	47 mm	NO	E2EQ-X2B1D12-M1TJ 0.3M	E2EQ-X2C112-M1TJ 0.3M
			NO+NC	E2EQ-X2B3D12-M1TJ 0.3M	E2EQ-X2C312-M1TJ 0.3M
M18 (5 mm)	Pre-wired (2 m) *1	55 mm	NO	E2EQ-X5B1D18 2M	E2EQ-X5C118 2M
			NO+NC	E2EQ-X5B3D18 2M	E2EQ-X5C318 2M
	M12 Pre-wired Smartclick Connector (0.3 m)	55 mm	NO	E2EQ-X5B1D18-M1TJ 0.3M	E2EQ-X5C118-M1TJ 0.3M
			NO+NC	E2EQ-X5B3D18-M1TJ 0.3M	E2EQ-X5C318-M1TJ 0.3M
M30 (10 mm)	Pre-wired (2 m) *1	60 mm	NO	E2EQ-X10B1D30 2M	E2EQ-X10C130 2M
			NO+NC	E2EQ-X10B3D30 2M	E2EQ-X10C330 2M
	M12 Pre-wired Smartclick Connector (0.3 m)	60 mm	NO	E2EQ-X10B1D30-M1TJ 0.3M	E2EQ-X10C130-M1TJ 0.3M
			NO+NC	E2EQ-X10B3D30-M1TJ 0.3M	E2EQ-X10C330-M1TJ 0.3M

*1. Models with 5-m cable length are also available (Example: E2EQ-X6B1D12 5M)

*2. M12 Connector Models are also available with "M1" suffix. (Example: E2EQ-X2B1D8-M1)

*3. NC models are also available. The model number is E2EQ-X□□□2□ (Example: E2EQ-X3B28 2M).

Note: 1. Models in are equipped with IO-Link (COM2). For IO-Link (COM3), select a model number with the format of "E2E-X□□□□□" (Example: E2EQ-X6B1T12 2M).

Operation mode NO can be changed to NC via IO-Link communications.

2. IO-Link is not supported for NC-type PNP outputs or all types of NPN outputs.

E2EQ NEXT Series

PREMIUM Model

E2EQ NEXT Series (Spatter-resistant Triple distance model)

DC 2-wire Shielded *1 [Refer to Ratings and Specification on page 51, Dimension on page 63.]

Size (Sensing distance)	Connection method	Polarity	Model	
			Operation mode: NO	Operation mode: NC
M8 (3 mm)	Pre-wired (2 m) *2	Yes	E2EQ-X3D18 2M	E2EQ-X3D28 2M
		No	E2EQ-X3D18-T 2M	E2EQ-X3D28-T 2M
	M12 Pre-wired Smartclick Connector (0.3 m)	Yes	E2EQ-X3D18-M1TGJ 0.3M	E2EQ-X3D28-M1TGJ 0.3M
		No	E2EQ-X3D18-M1TGJ-T 0.3M	E2EQ-X3D28-M1TGJ-T 0.3M
M12 (7 mm)	Pre-wired (2 m) *2	Yes	E2EQ-X7D112 2M	E2EQ-X7D212 2M
		No	E2EQ-X7D112-T 2M	E2EQ-X7D212-T 2M
	M12 Pre-wired Smartclick Connector (0.3 m)	Yes	E2EQ-X7D112-M1TGJ 0.3M	E2EQ-X7D212-M1TGJ 0.3M
		No	E2EQ-X7D112-M1TGJ-T 0.3M	E2EQ-X7D212-M1TGJ-T 0.3M
M18 (11 mm)	Pre-wired (2 m) *2	Yes	E2EQ-X11D118 2M	E2EQ-X11D218 2M
		No	E2EQ-X11D118-T 2M	E2EQ-X11D218-T 2M
	M12 Pre-wired Smartclick Connector (0.3 m)	Yes	E2EQ-X11D118-M1TGJ 0.3M	E2EQ-X11D218-M1TGJ 0.3M
		No	E2EQ-X11D118-M1TGJ-T 0.3M	E2EQ-X11D218-M1TGJ-T 0.3M
M30 (20 mm)	Pre-wired (2 m) *2	Yes	E2EQ-X20D130 2M	E2EQ-X20D230 2M
		No	E2EQ-X20D130-T 2M	E2EQ-X20D230-T 2M
	M12 Pre-wired Smartclick Connector (0.3 m)	Yes	E2EQ-X20D130-M1TGJ 0.3M	E2EQ-X20D230-M1TGJ 0.3M
		No	E2EQ-X20D130-M1TGJ-T 0.3M	E2EQ-X20D230-M1TGJ-T 0.3M

*1. When embedding the Proximity Sensor in metal, refer to *Influence of Surrounding Metal* on page 61.

*2. Models with 5-m cable length are also available with "5M" suffix. (Example: E2EQ-X3D18 5M)

PREMIUM Model

E2EQ NEXT Series (Spatter-resistant Triple distance model)

DC 3-wire Shielded *1 [Refer to Ratings and Specification on page 52, Dimension on page 63.]

Size (Sensing distance)	Connection method *3	Body size	Operation mode *4	Model	
				PNP	NPN
M8 (3 mm)	Pre-wired (2 m) *2	38 mm	NO	E2EQ-X3B1D8 2M	E2EQ-X3C18 2M
	M12 Pre-wired Smartclick Connector (0.3 m)	38 mm	NO	E2EQ-X3B1D8-M1TJ 0.3M	E2EQ-X3C18-M1TJ 0.3M
M12 (6 mm)	Pre-wired (2 m) *2	47 mm	NO	E2EQ-X6B1D12 2M	E2EQ-X6C112 2M
			NO+NC	E2EQ-X6B3D12 2M	E2EQ-X6C312 2M
	M12 Pre-wired Smartclick Connector (0.3 m)	47 mm	NO	E2EQ-X6B1D12-M1TJ 0.3M	E2EQ-X6C112-M1TJ 0.3M
			NO+NC	E2EQ-X6B3D12-M1TJ 0.3M	E2EQ-X6C312-M1TJ 0.3M
M18 (12 mm)	Pre-wired (2 m) *2	55 mm	NO	E2EQ-X12B1D18 2M	E2EQ-X12C118 2M
			NO+NC	E2EQ-X12B3D18 2M	E2EQ-X12C318 2M
	M12 Pre-wired Smartclick Connector (0.3 m)	55 mm	NO	E2EQ-X12B1D18-M1TJ 0.3M	E2EQ-X12C118-M1TJ 0.3M
			NO+NC	E2EQ-X12B3D18-M1TJ 0.3M	E2EQ-X12C318-M1TJ 0.3M
M30 (22 mm)	Pre-wired (2 m) *2	60 mm	NO	E2EQ-X22B1D30 2M	E2EQ-X22C130 2M
			NO+NC	E2EQ-X22B3D30 2M	E2EQ-X22C330 2M
	M12 Pre-wired Smartclick Connector (0.3 m)	60 mm	NO	E2EQ-X22B1D30-M1TJ 0.3M	E2EQ-X22C130-M1TJ 0.3M
			NO+NC	E2EQ-X22B3D30-M1TJ 0.3M	E2EQ-X22C330-M1TJ 0.3M

*1. When embedding the Proximity Sensor in metal, refer to *Influence of Surrounding Metal* on page 61.

*2. Models with 5-m cable length are also available (Example: E2EQ-X6B1D12 5M)

*3. M12 Connector Models are also available with "M1" suffix. (Example: E2EQ-X3B1D8-M1).

*4. NC models are also available. The model number is E2EQ-□□□□ (Example: E2EQ-X3B28 2M).

Note: 1. Models in are equipped with IO-Link (COM2). For IO-Link (COM3), select a model number with the format of "E2E-X□□□□T□" (Example: E2EQ-X6B1T12 2M).

Operation mode NO can be changed to NC via IO-Link communications.

2. IO-Link is not supported for NC-type PNP outputs or all types of NPN outputs.

Sensor I/O Connectors (Sold Separately)

For details of the connector, refer to XS5 Series on page 70.

Ratings and Specifications

BASIC Model

E2EQ NEXT Series (Spatter-resistant Double distance model)
DC 2-wire Shielded

Item	Size Model	M12	M18	M30
		E2EQ-X4D□12	E2EQ-X8D□18	E2EQ-X15D□30
Sensing distance		4 mm ±10%	8 mm ±10%	15 mm ±10%
Setting distance *1		0 to 3.2 mm	0 to 6.4 mm	0 to 12 mm
Differential travel		15% max. of sensing distance		
Detectable object		Ferrous metals (For non-ferrous metals, refer to <i>Engineering Data</i> on page 53.)		
Standard sensing object (Iron)		12 × 12 × 1 mm	18 × 18 × 1 mm	30 × 30 × 1 mm
Response frequency *2		1,000 Hz	500 Hz	250 Hz
Power supply voltage		10 to 30 VDC (including 10% ripple (p-p)), Class 2		
Current consumption		0.8 mA max.		
Control output	Load current	3 to 100 mA		
	Residual voltage	5 V max. (Load current: 100 mA, Cable length: 2 m)		
Indicator		Operation indicator (orange), Setting indicator (green)		
Operation mode		NO Refer to the timing charts under <i>I/O Circuit Diagrams/Timing charts</i> on page 56 for details.		
Protection circuits		Surge suppressor, Load short-circuit protection		
Ambient temperature range		Operating: -25 to 70°C, Storage: -40 to 85°C (with no icing or condensation)		
Ambient humidity range		Operating and Storage: 35% to 95% (with no condensation)		
Temperature influence		±10% max. of sensing distance at 23°C in the temperature range of -25 to 70°C		
Voltage influence		±1% max. of sensing distance at rated voltage in the rated voltage ±15% range		
Insulation resistance		50 MΩ min. (at 500 VDC) between current-carrying parts and case		
Dielectric strength		1,000 VAC, 50/60 Hz for 1 minute between current-carrying parts and case		
Vibration resistance (destruction)		10 to 55 Hz, 1.5-mm double amplitude for 2 hours each in X, Y, and Z directions		
Shock resistance (destruction)		1,000 m/s ² 10 times each in X, Y, and Z directions		
Degree of protection		Pre-wired Models, Pre-wired Connector Models: IEC 60529:IP67, JIS C 0920 Annex 1: IP67G		
Connection method		Pre-wired Models (Standard cable length: 2 m) and M12 Pre-wired Smartclick Connector Models (Standard cable length: 0.3 m)		
Weight (packed state)	Pre-wired	Approx. 100 g	Approx. 180 g	Approx. 250 g
	M12 Pre-wired Smartclick Connector	Approx. 75 g	Approx. 110 g	Approx. 180 g
Materials	Materials	Fluororesin coating (Base material: brass)		
	Sensing surface	Fluororesin		
	Clamping nuts	Fluororesin coating (Base material: brass)		
	Toothed washer	Zinc-plated iron		
	Cable	Vinyl chloride (PVC)		
Accessories		Instruction manual, Clamping nuts, Toothed washer		

*1. Use the Sensor within the range in which the setting indicator (green LED) is ON.

*2. The response frequency is an average value. Measurement conditions are as follows: standard sensing object, a distance of twice the standard sensing object, and a set distance of half the sensing distance.

E2EQ NEXT Series

BASIC Model

E2EQ NEXT Series (Spatter-resistant Double distance/Single distance model) DC 3-wire Shielded

Item	Types Size Model	Double distance Models				Single distance Models			
		M8	M12	M18	M30	M8	M12	M18	M30
		E2EQ-X2□8	E2EQ-X4□12	E2EQ-X8□18	E2EQ-X15□30	E2EQ-X1R5□8	E2EQ-X2□12	E2EQ-X5□18	E2EQ-X10□30
Sensing distance		2 mm±10%	4 mm±10%	8 mm±10%	15 mm±10%	1.5 mm±10%	2 mm±10%	5 mm±10%	10 mm±10%
Setting distance		0 to 1.6 mm	0 to 3.2 mm	0 to 6.4 mm	0 to 12 mm	0 to 1.2 mm	0 to 1.6 mm	0 to 4 mm	0 to 8 mm
Differential travel		15% max. of sensing distance				10% max. of sensing distance			
Detectable object		Ferrous metals (For non-ferrous metals, refer to the <i>Engineering Data</i> on page 53.)							
Standard sensing object (Iron)		8 × 8 × 1 mm	12 × 12 × 1 mm	24 × 24 × 1 mm	45 × 45 × 1 mm	8 × 8 × 1 mm	12 × 12 × 1 mm	18 × 18 × 1 mm	30 × 30 × 1 mm
Response frequency *1		1,500 Hz	1,000 Hz	500 Hz	250 Hz	2,000 Hz	1,500 Hz	600 Hz	400 Hz
Power supply voltage		10 to 30 VDC (including 10% ripple (p-p)), Class 2							
Current consumption		1-output models: 16 mA max., 2-output models: 20 mA max.							
Output configuration		B□ Models: PNP open collector, C□ Models: NPN open collector							
Operation mode (with sensing object approaching)		1-output models (B1, C1): NO (Normally open), 1-output models (B2, C2): NC (Normally closed) 2-output models (B3, C3): NO+NC (Normally open, Normally closed)							
Control output	Load current	M8 size 1-output models: 10 to 30 VDC, Class 2, 200 mA max., (-40 to 70°C), 100 mA max., (70 to 85°C) 2-output models: 10 to 30 VDC, Class 2, 50 mA max. M12, M18, M30 size 1-output models: 10 to 30 VDC, Class 2, 200 mA max., 2-output models: 10 to 30 VDC, Class 2, 100 mA max.							
	Residual voltage	M8 size 1-output models: 2 V max. (Load current: 200 mA, Cable length: 2 m), 2-output models: 2 V max. (Load current: 50 mA, Cable length: 2 m) M12, M18, M30 size 1-output models: 2 V max. (Load current: 200 mA, Cable length: 2 m), 2-output models: 2 V max. (Load current: 100 mA, Cable length: 2 m)							
Indicator *2		In the Standard I/O mode (SIO mode): Operation indicator (orange, lit) and communication indicator (green, not lit) In the IO-Link communication mode (COM mode): Operation indicator (orange, lit) and communication indicator (green, blinking at 1 s intervals)							
Protection circuits		Power supply reverse polarity protection, Surge suppressor, Output short-circuit protection, Output reverse polarity protection							
Ambient temperature range		Operating/Storage: -40 to 85°C (with no icing or condensation) Note: The UL temperature rating for M12 Pre-wired Connector Models is -25 to 70°C.							
Ambient humidity range		Operating/Storage: 35% to 95% (with no condensation)							
Temperature influence		±15% max. of sensing distance at 23°C in the temperature range of -40 to 85°C ±10% max. of sensing distance at 23°C in the temperature range of -25 to 70°C							
Voltage influence		±1% max. of sensing distance at rated voltage in the rated voltage ±15% range							
Insulation resistance		50 MΩ min. (at 500 VDC) between current-carrying parts and case							
Dielectric strength		1,000 VAC, 50/60 Hz for 1 minute between current-carrying parts and case							
Vibration resistance (destruction)		10 to 55 Hz, 1.5-mm double amplitude for 2 hours each in X, Y, and Z directions							
Shock resistance (destruction)		M8 size: 500 m/s ² 10 times each in X, Y, and Z directions/M12, M18, M30 size: 1,000 m/s ² 10 times each in X, Y, and Z directions							
Degree of protection		Pre-wired Models, Pre-wired Connector Models: IEC 60529:IP67, JIS C 0920 Annex 1: IP67G *4/Connector Models: IEC 60529 IP67							
Connection method		Pre-wired Models (Standard cable length: 2 m) and Pre-wired Connector Models (Standard cable length: 0.3 m), M12 Connector Models							
Weight *3 (packed state)	Pre-wired	Approx. 85 g	Approx. 95 g	Approx. 170 g	Approx. 240 g	Approx. 85 g	Approx. 95 g	Approx. 170 g	Approx. 240 g
	M12 Pre-wired Smartclick Connector	Approx. 55 g	Approx. 70 g	Approx. 105 g	Approx. 170 g	Approx. 55 g	Approx. 70 g	Approx. 105 g	Approx. 170 g
	Connector	Approx. 40 g	Approx. 55 g	Approx. 85 g	Approx. 160 g	Approx. 40 g	Approx. 55 g	Approx. 85 g	Approx. 160 g
Materials	Case	M8 size: Fluororesin coating (Base material: SUS303)/M12, M18, M30 size: Fluororesin coating (Base material: brass)							
	Sensing surface	Fluorine resin							
	Clamping nuts	Fluororesin coating (Base material: brass)							
	Toothed washers	Zinc-plated iron							
	Cable	Vinyl chloride (PVC)							
Main IO-Link functions *2		Operation mode switching between NO and NC, self diagnosis enabling, excessive proximity judgment distance selecting, timer function of the control output and timer time selecting, instability output (IO-Link mode) ON delay timer time selecting function, monitor output, operating hours read-out, readout of the sensor internal temperature, and initial reset							
IO-Link Communication specifications *2	IO-Link specification	Ver1.1							
	Baud rate	COM2 (38.4 kbps), COM3 (230.4 kbps)							
	Data length	PD size: 2 bytes, OD size: 1 byte (M-sequence type: TYPE_2_2)							
	Minimum cycle time	COM2: 2.3 ms, COM3: 0.4 ms							
Accessories		Instruction manual, Clamping nuts, Toothed washer							

*1. The response frequency is an average value. Measurement conditions are as follows: standard sensing object, a distance of twice the standard sensing object, and a set distance of half the sensing distance.

*2. IO-Link is not supported for NC-type PNP outputs or all types of NPN outputs.

*3. Weight of the standard body-sized model.

*4. The IP67G is the degree of protection which is defined according to the JIS (Japanese Industrial Standards).

The IP67 indicates the same level of protection as defined by the IEC, and the G indicates that a device has resistance to oil.

PREMIUM Model

E2EQ NEXT Series (Spatter-resistant Triple distance model)
DC 2-wire Shielded

Item	Size	M8	M12	M18	M30
	Model	E2EQ-X3D□	E2EQ-X7D□	E2EQ-X11D□	E2EQ-X20D□
Sensing distance		3 mm ±10%	7 mm ±10%	11 mm ±10%	20 mm ±10%
Setting distance *1		0 to 2.4 mm	0 to 4.9 mm	0 to 8.8 mm	0 to 16 mm
Differential travel		15% max. of sensing distance			
Detectable object		Ferrous metal (The sensing distance decreases with non-ferrous metal. Refer to <i>Engineering Data</i> on page 53.)			
Standard sensing object (Iron)		9 × 9 × 1 mm	21 × 21 × 1 mm	33 × 33 × 1 mm	60 × 60 × 1 mm
Response frequency *2		250 Hz	250 Hz	250 Hz	200 Hz
Power supply voltage		10 to 30 VDC, (including 10% ripple (p-p))			
Leakage current		0.8 mA max.			
Control output	Load current	3 to 100 mA			
	Residual voltage	Polarity: 3 V max. (Load current: 100 mA, Cable length: 2 m) No polarity: 5 V max. (Load current: 100 mA, Cable length: 2 m)			
Indicator		D1 Models: Operation indicator (orange), Setting indicator (green) D2 Models: Operation indicator (orange)			
Operation mode		D1 Models: NO D2 Models: NC Refer to the timing charts under <i>I/O Circuit Diagrams/Timing charts</i> on page 56 for details.			
Protection circuits		Surge suppressor, Load short-circuit protection			
Ambient temperature range		Operating: -25 to 70°C, Storage: -40 to 85°C (with no icing or condensation)			
Ambient humidity range		Operating and Storage: 35% to 95% (with no condensation)			
Temperature influence		±10% max. of sensing distance at 23°C in the temperature range of -25 to 70°C		±20% max. of sensing distance at 23°C in the temperature range of -25 to 70°C	
Voltage influence		±1% max. of sensing distance at rated voltage in the rated voltage ±15% range			
Insulation resistance		50 MΩ min. (at 500 VDC) between current-carrying parts and case			
Dielectric strength		1,000 VAC, 50/60 Hz for 1 minute between current-carrying parts and case			
Vibration resistance (destruction)		10 to 55 Hz, 1.5-mm double amplitude for 2 hours each in X, Y, and Z directions			
Shock resistance (destruction)		500 m/s ² 10 times each in X, Y, and Z directions	1,000 m/s ² 10 times each in X, Y, and Z directions		
Degree of protection		Pre-wired/Pre-wired M12 Connector: IP67 (IEC 60529) and IP67G *3 (JIS C 0920 Annex 1)			
Connecting method		Pre-wired (Standard cable length: 2 m) and Pre-wired M12 Connector (Standard cable length: 0.3 m)			
Weight (packed state)	Pre-wired	Approx. 60 g	Approx. 70 g	Approx. 150 g	Approx. 210 g
	Pre-wired M12 Connector	Approx. 30 g	Approx. 40 g	Approx. 90 g	Approx. 140 g
Materials	Case	Fluororesin coating (Base material: brass)			
	Sensing surface	Fluororesin			
	Clamping nuts	Fluororesin coating (Base material: brass)			
	Toothed washer	Zinc-plated iron			
	Cable	Vinyl chloride (PVC)			
Accessories		Instruction manual, Clamping nuts, Toothed washer			

*1. Use the Sensor within the range in which the setting indicator (green LED) is ON (except D2 Models).

*2. The response frequency is an average value. Measurement conditions are as follows: standard sensing object, a distance of twice the standard sensing object, and a set distance of half the sensing distance.

*3. The IP67G is the degree of protection which is defined according to the JIS (Japanese Industrial Standards).

The IP67 indicates the same level of protection as defined by the IEC, and the G indicates that a device has resistance to oil.

E2EQ NEXT Series

PREMIUM Model

E2EQ NEXT Series (Spatter-resistant Triple distance model) DC 3-wire Shielded

Item	Size	M8	M12	M18	M30
	Model	E2EQ-X3□8	E2EQ-X6□12	E2EQ-X12□18	E2EQ-X22□30
Sensing distance		3 mm±10%	6 mm±10%	12 mm±10%	22 mm±10%
Setting distance		0 to 2.4 mm	0 to 4.8 mm	0 to 9.6 mm	0 to 16.8 mm
Differential travel		15% max. of sensing distance			
Detectable object		Ferrous metals (For non-ferrous metals, refer to the <i>Engineering Data</i> on page 53.)			
Standard sensing object (Iron)		9 × 9 × 1 mm	18 × 18 × 1 mm	36 × 36 × 1 mm	66 × 66 × 1 mm
Response frequency *1		1,000 Hz	800 Hz	500 Hz	200 Hz
Power supply voltage		10 to 30 VDC (including 10% ripple (p-p)), Class 2			
Current consumption		1-output models: 16 mA max., 2-output models: 20 mA max.			
Output configuration		B□ Models: PNP open collector, C□ Models: NPN open collector			
Operation mode (with sensing object approaching)		1-output models (B1, C1): NO (Normally open), 1-output models (B2, C2): NC (Normally closed)		1-output models (B1, C1): NO (Normally open), 1-output models (B2, C2): NC (Normally closed), 2-output models (B3, C3): NO+NC (Normally open, Normally closed)	
Control output	Load current	1-output models: 10 to 30 VDC, Class 2, 100 mA max.		1-output models: 10 to 30 VDC, Class 2, 100 mA max., 2-output models: 10 to 30 VDC, Class 2, 50 mA max.	
	Residual voltage	1-output models: 2 V max. (Load current: 100 mA, Cable length: 2 m)		1-output models: 2 V max. (Load current: 100 mA, Cable length: 2 m), 2-output models: 2 V max. (Load current: 50 mA, Cable length: 2 m)	
Indicator *2		In the Standard I/O mode (SIO mode): Operation indicator (orange, lit) and communication indicator (green, not lit) In the IO-Link communication mode (COM mode): Operation indicator (orange, lit) and communication indicator (green, blinking at 1 s intervals)			
Protection circuits		Power supply reverse polarity protection, Surge suppressor, Output short-circuit protection, Output reverse polarity protection			
Ambient temperature range		Operating/Storage: -25 to 70°C (with no icing or condensation)			
Ambient humidity range		Operating/Storage: 35% to 95% (with no condensation)			
Temperature influence		±10% max. of sensing distance at 23°C in the temperature range of -25 to 70°C			
Voltage influence		±1% max. of sensing distance at rated voltage in the rated voltage ±15% range			
Insulation resistance		50 MΩ min. (at 500 VDC) between current-carrying parts and case			
Dielectric strength		1,000 VAC, 50/60 Hz for 1 minute between current-carrying parts and case			
Vibration resistance (destruction)		10 to 55 Hz, 1.5-mm double amplitude for 2 hours each in X, Y, and Z directions			
Shock resistance (destruction)		500 m/s ² 10 times each in X, Y, and Z directions	1,000 m/s ² 10 times each in X, Y, and Z directions		
Degree of protection		Pre-wired Models, Pre-wired Connector Models: IEC 60529: IP67, JIS C 0920 Annex 1: IP67G *4 Connector Models: IEC 60529: IP67			
Connection method		Pre-wired Models (Standard cable length: 2 m) and Pre-wired Connector Models (Standard cable length: 0.3 m), M12 Connector Models			
Weight *3 (packed state)	Pre-wired Models	Approx. 85 g	Approx. 95 g	Approx. 180 g	Approx. 260 g
	M12 Pre-wired Smartclick Connector	Approx. 55 g	Approx. 70 g	Approx. 115 g	Approx. 200 g
	Connector	Approx. 40 g	Approx. 55 g	Approx. 95 g	Approx. 180 g
Materials	Case	Fluororesin coating (Base material: brass)			
	Sensing surface	Fluorine resin			
	Clamping nuts	Fluororesin coating (Base material: brass)			
	Toothed washers	Zinc-plated iron			
	Cable	Vinyl chloride (PVC)			
Main IO-Link functions *2		Operation mode switching between NO and NC, self diagnosis enabling, excessive proximity judgment distance selecting, timer function of the control output and timer time selecting, instability output (IO-Link mode) ON delay timer time selecting function, monitor output, operating hours read-out, readout of the sensor internal temperature, and initial reset			
IO-Link Communication specifications *2	IO-Link specification	Ver 1.1			
	Baud rate	COM2 (38.4 kbps), COM3 (230.4 kbps)			
	Data length	PD size: 2 bytes, OD size: 1 byte (M-sequence type: TYPE_2_2)			
	Minimum cycle time	COM2: 2.3 ms, COM3: 0.4 ms			
Accessories		Instruction manual, Clamping nuts, Toothed washer			

*1. The response frequency is an average value. Measurement conditions are as follows: standard sensing object, a distance of twice the standard sensing object, and a set distance of half the sensing distance.

*2. IO-Link is not supported for NC-type PNP outputs or all types of NPN outputs.

*3. Weight of the standard body-sized model.

*4. The IP67G is the degree of protection which is defined according to the JIS (Japanese Industrial Standards).

The IP67 indicates the same level of protection as defined by the IEC, and the G indicates that a device has resistance to oil.

Engineering Data (Reference Value)

Sensing Area

BASIC Model

DC 2-wire
Spatter-resistant Double distance model

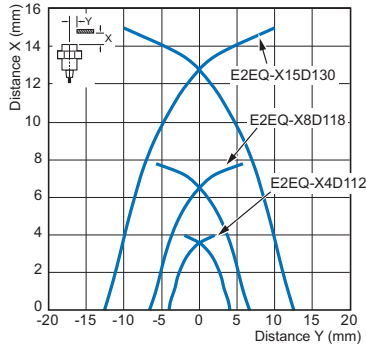

PREMIUM Model

DC 2-wire
Spatter-resistant Triple distance model

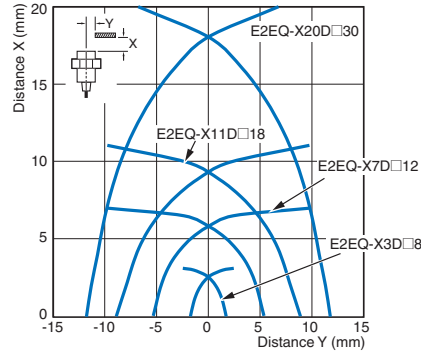

Leakage Current

DC 2-wire
Spatter-resistant Triple distance/
Double distance model
E2EQ-X□D□(-T)

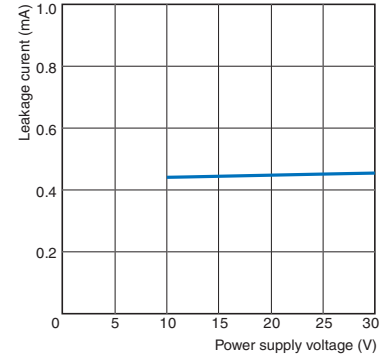

DC 3-wire
Spatter-resistant Double distance model

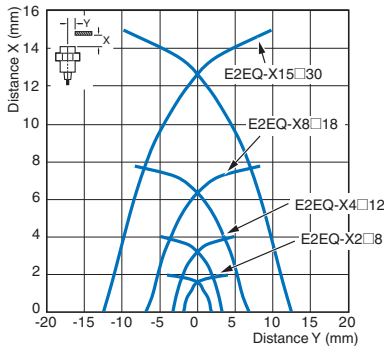

DC 3-wire
Spatter-resistant Triple distance model

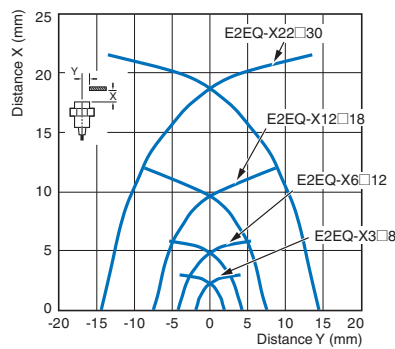

Residual Output Voltage

DC 2-wire
Spatter-resistant Triple distance/
Double distance model
E2EQ-X□D□(-T)

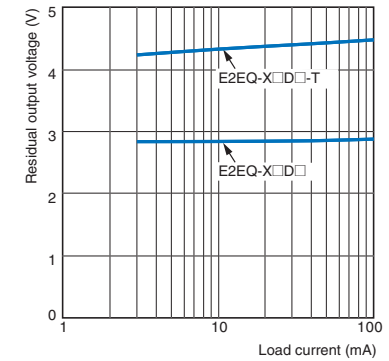

DC 3-wire
Spatter-resistant Single distance model

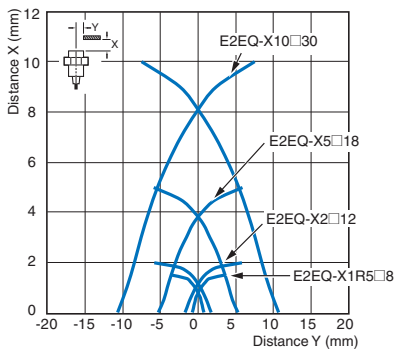

Influence of Sensing Object Size and Material

BASIC Model

DC 2-wire/3-wire
Spatter-resistant
Double distance model

Size: M8
 E2EQ-X2□8

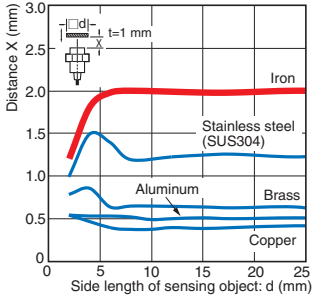

Size: M12
 E2EQ-X4□12

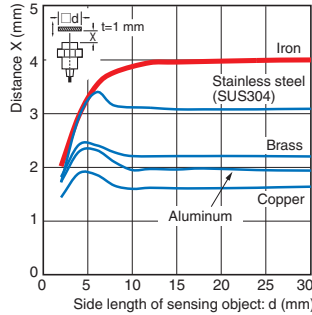

Size: M18
 E2EQ-X8□18

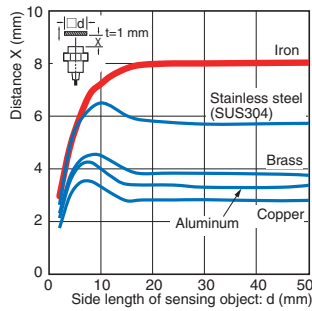

Size: M30
 E2EQ-X15□30

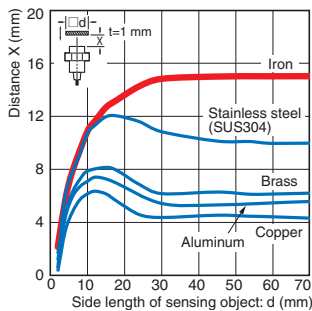

BASIC Model

DC 3-wire
Spatter-resistant
Single distance model

Size: M8
 E2EQ-X1R5□8

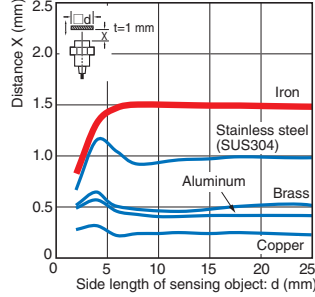

Size: M12
 E2EQ-X2□12

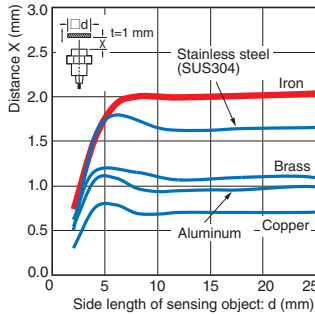

Size: M18
 E2EQ-X5□18

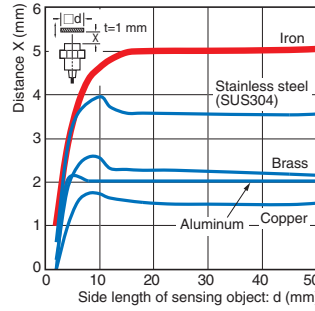

Size: M30
 E2EQ-X10□30

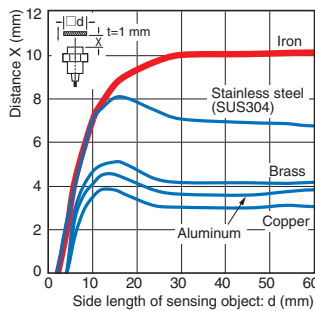

PREMIUM Model

DC 2-wire
Spatter-resistant
Triple distance model

Size: M8
 E2EQ-X3D□8

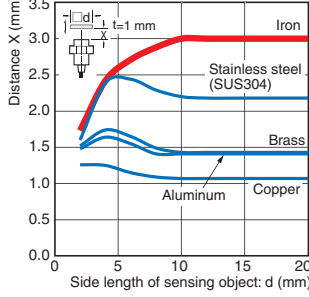

Size: M12
 E2EQ-X7D□12

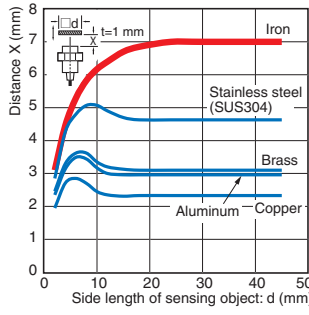

Size: M18
 E2EQ-X11D□18

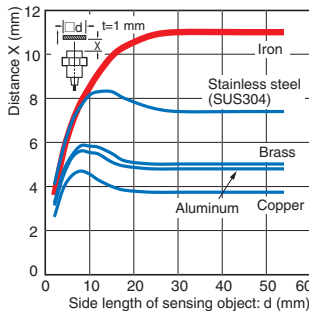

Size: M30
 E2EQ-X20D□30

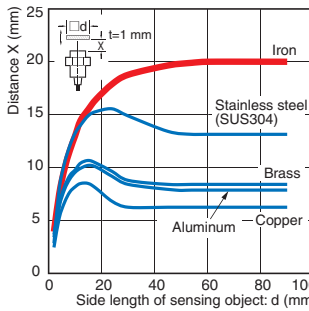

PREMIUM Model

DC 3-wire
Spatter-resistant
Triple distance model

Size: M8
 E2EQ-X3□8

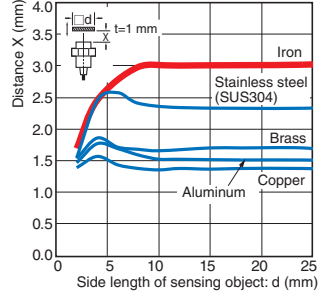

Size: M12
 E2EQ-X6□12

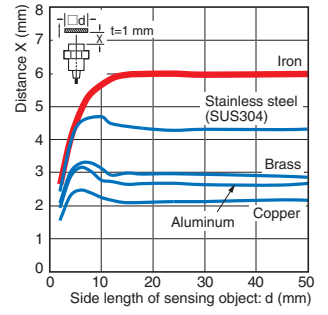

Size: M18
 E2EQ-X12□18

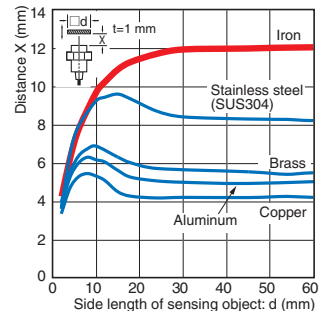

Size: M30
 E2EQ-X22□30

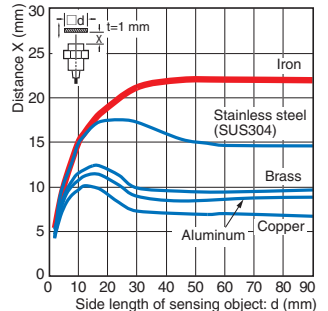

Monitor Output vs. Sensing Distance

BASIC Model

DC 3-wire
Spatter-resistant
Double distance model

Size: M8
E2EQ-X2□8

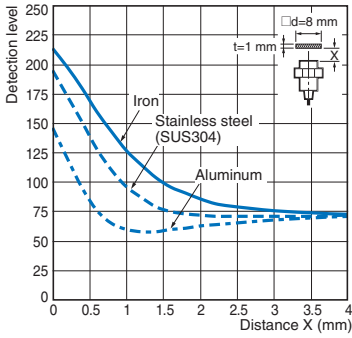

Size: M12
E2EQ-X4□12

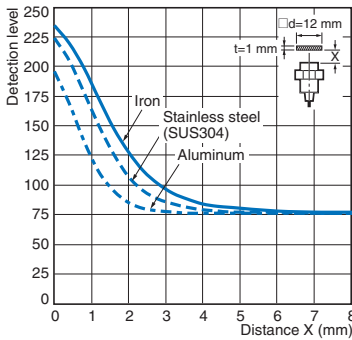

Size: M18
E2EQ-X8□18

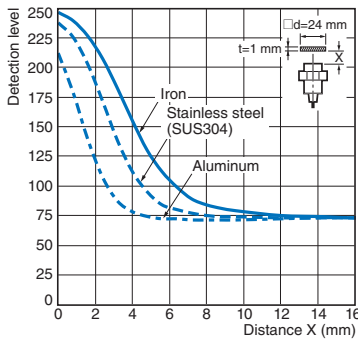

Size: M30
E2EQ-X15□30

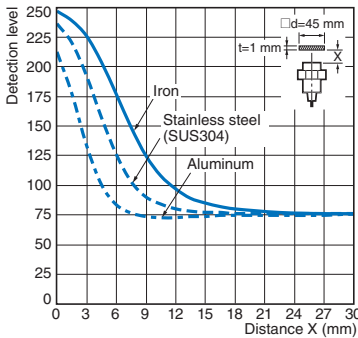

BASIC Model

DC 3-wire
Spatter-resistant
Single distance model

Size: M8
E2EQ-X1R5□8

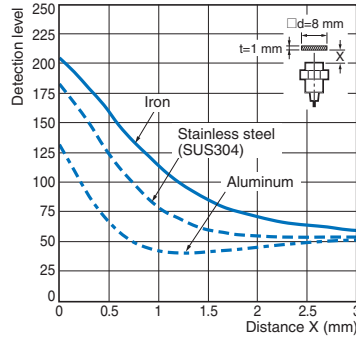

Size: M12
E2EQ-X2□12

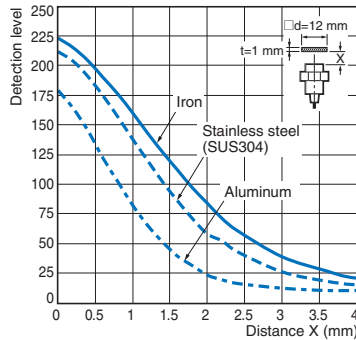

Size: M18
E2EQ-X5□18

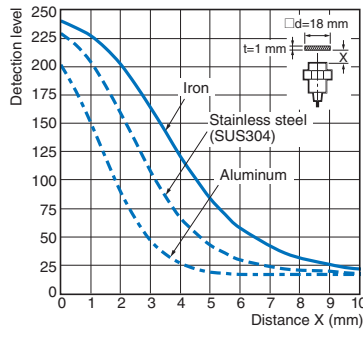

Size: M30
E2EQ-X10□30

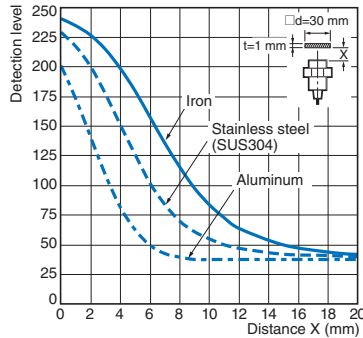

PREMIUM Model

DC 3-wire
Spatter-resistant
Triple distance model

Size: M8
E2EQ-X3□8

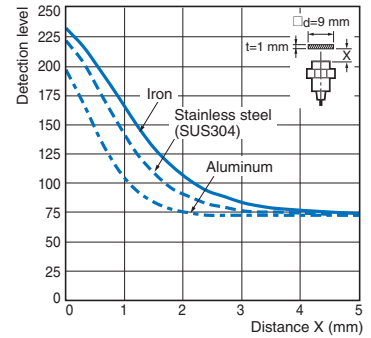

Size: M12
E2EQ-X6□12

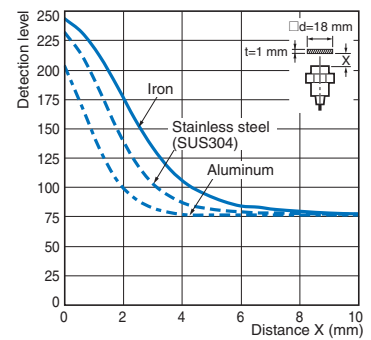

Size: M18
E2EQ-X12□18

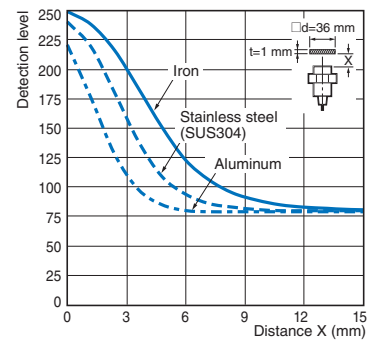

Size: M30
E2EQ-X22□30

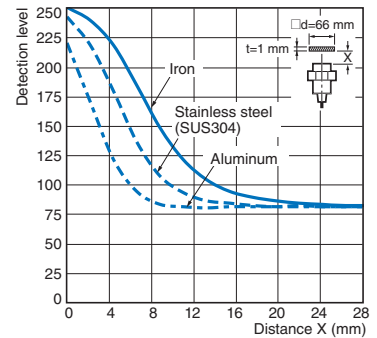

E2EQ NEXT Series

I/O Circuit Diagrams/Timing charts

DC 2-wire Models

Operation mode	Model	Timing Chart	Output circuit
NO	E2EQ-X□D1□	<p>Non-sensing area Unstable sensing area Stable sensing area</p> <p>Sensing object</p> <p>Proximity Sensor</p> <p>(%) 100 80 0</p> <p>Set position</p> <p>ON Setting indicator (green) OFF</p> <p>ON Operation indicator (orange) OFF</p> <p>ON Control output OFF</p>	<p>Proximity sensor main circuit</p> <p>Brown ① Load 10 to 30 VDC</p> <p>Blue ④ 0 V</p> <p>Connector Pin Arrangement</p> <p>Note: Pins 2 and 3 are not used.</p> <p>Note: The load can be connected to either the +V or 0 V side.</p>
	E2EQ-X□D1□-T	<p>Rated sensing distance</p> <p>ON Setting indicator (green) OFF</p> <p>ON Operation indicator (orange) OFF</p> <p>ON Control output OFF</p>	<p>Proximity sensor main circuit</p> <p>Brown ④ Load 10 to 30 VDC (0V)</p> <p>Blue ③ 0V (10 to 30 VDC)</p> <p>Connector Pin Arrangement</p> <p>Note: Pins 1 and 2 are not used.</p> <p>Note1. The load can be connected to either the +V or 0 V side. 2. The E2EQ-X□D1□(-M1TGJ)-T has no polarity. There is no need to be concerned about the polarity of brown and blue wires, or pins 3 and 4.</p>
NC	E2EQ-X□D2□	<p>Non-sensing area Sensing area</p> <p>Sensing object</p> <p>Proximity Sensor</p> <p>(%) 100 0</p> <p>Rated sensing distance</p> <p>ON Operation indicator (orange) OFF</p> <p>ON Control output OFF</p>	<p>Proximity sensor main circuit</p> <p>Brown ① Load 10 to 30 VDC</p> <p>Blue ② 0 V</p> <p>Connector Pin Arrangement</p> <p>Note: Pins 3 and 4 are not used.</p> <p>Note: The load can be connected to either the +V or 0 V side.</p>
	E2EQ-X□D2□-T	<p>Rated sensing distance</p> <p>ON Operation indicator (orange) OFF</p> <p>ON Control output OFF</p>	<p>Proximity sensor main circuit</p> <p>Brown ① Load 10 to 30 VDC (0V)</p> <p>Blue ② 0V (10 to 30 VDC)</p> <p>Connector Pin Arrangement</p> <p>Note: Pins 3 and 4 are not used.</p> <p>Note1. The load can be connected to either the +V or 0 V side. 2. The E2EQ-X□D1□(-M1TGJ)-T has no polarity. There is no need to be concerned about the polarity of brown and blue wires, or pins 1 and 2.</p>

DC 3-wire PNP output

Operation mode	Model	Output circuit	
		Standard I/O mode (SIO mode) When using as a general	IO-Link Communication mode (COM mode) When using the Sensor connected to IO-Link Master Unit *
NO	E2EQ-□B1		
NC	E2EQ-□B2	<p>Note: M8 (3-pin) Connector: (1)(4)(3)</p>	---
NO+NC	E2EQ-□B3		

* In the IO-Link mode, the cord between the IO-Link master and sensor must have a length of 20 m or less.

Connector Pin Arrangement

M12 Connector M12 Smartclick Connector	M8 (4-pin) Connector	M8 (3-pin) Connector

DC 3-wire PNP output

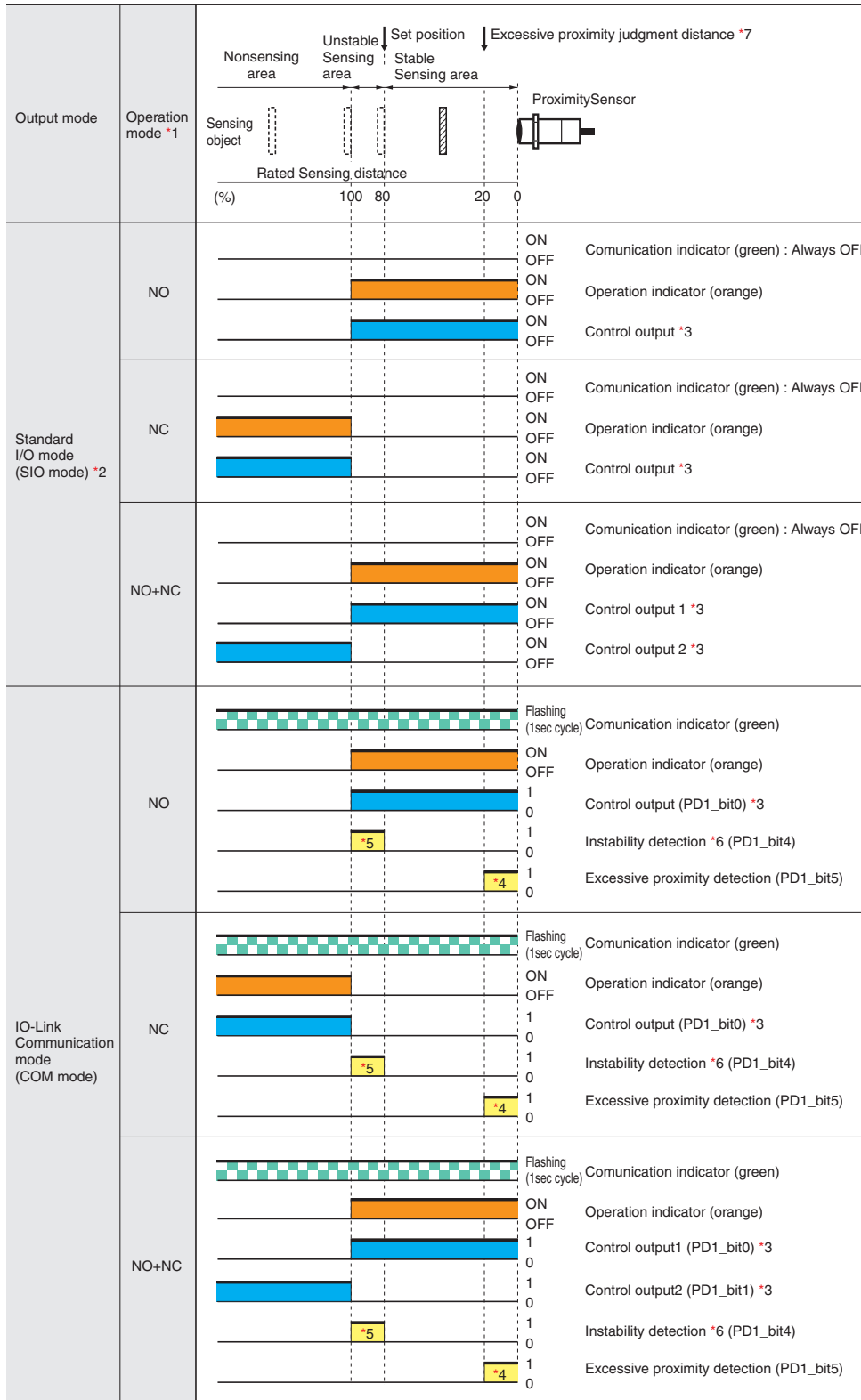

*3. The timer function of the control output can be set up by the IO-Link communications. (It is able to select ON delay, OFF delay, or one-shot function and select a timer time of 1 to 16,383ms (T).)

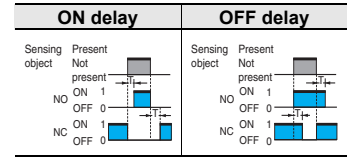

One shot

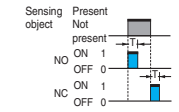

- *4. The excessive proximity diagnosis function can be selected by the IO-Link communications.
 - *5. The instability detection diagnosis can be selected by the IO-Link communications.
 - *6. The judgment time for the instability detection diagnosis can be selected by the IO-Link communications. (For the ON delay timer function, the setting can be selected from 0 (invalid), 10, 50, 100, 300, 500, or 1000 ms.)
 - *7. The judgment distance of the excessive proximity diagnosis function can be selected by the IO-Link communications. (The distance can be selected as a combination of the material of the object detected, such as iron, aluminum, or SUS and the judgment distance of approximately 10, 20, or 30%. However, it is not allowed to select a combination of aluminum and 30%.)
- Please contact your OMRON sales representative regarding the IO-Link setup file (IODD file).

Please contact your OMRON sales representative regarding assignment of data.

*1. For models with IO-Link, the operation mode can be changed by the IO-Link communications.

*2. If using a model with IO-Link as a general sensor or using a model without IO-Link, it operates in the standard I/O mode (SIO mode).

DC 3-wire
NPN output

Operation mode	Model	Output circuit
NO	E2E(Q)-□C1	
NC	E2E(Q)-□C2	<p>Note: M8 (3-pin) Connector: (1)(4)(3)</p>
NO+NC	E2E(Q)-□C3	

Connector Pin Arrangement

M12 Connector M12 Smartclick Connector	M8 (4-pin) Connector	M8 (3-pin) Connector

Operation mode	Sensing area		Proximity Sensor	Control output	
	Nonsensing area	Stable sensing area		ON	OFF
NO				ON	Operation indicator (orange)
				OFF	Control output
NC				ON	Operation indicator (orange)
				ON	Control output
				OFF	Control output
NO+NC				ON	Operation indicator (orange)
				OFF	Control output 1
				ON	Control output 2
				OFF	Control output 2

Be sure to read the precautions for all models in the website at: <http://www.ia.omron.com/>.

Warning Indications

⚠ WARNING	Warning level Indicates a potentially hazardous situation which, if not avoided, will result in minor or moderate injury, or may result in serious injury or death. Additionally there may be significant property damage.
Precautions for Safe Use	Supplementary comments on what to do or avoid doing, to use the product safely.
Precautions for Correct Use	Supplementary comments on what to do or avoid doing, to prevent failure to operate, malfunction or undesirable effect on product performance.

Meaning of Product Safety Symbols

	General prohibition Indicates the instructions of unspecified prohibited action.
	Caution, explosion Indicates the possibility of explosion under specific conditions.

⚠ WARNING

This product is not designed or rated for ensuring safety of persons either directly or indirectly. Do not use it for such purposes.

Otherwise, explosion may result. Never use the product with an AC power supply.

Precautions for Safe Use

The following precautions must be observed to ensure safe operation.

1. Do not use the product in environments subject to flammable or explosive gases.
2. Do not attempt to disassemble, repair, or modify the product.
3. Do not use a voltage that exceeds the rated operating voltage range.
Applying a voltage that is higher than the operating voltage range may result in explosion or fire.
4. Be sure that the power supply polarity and other wiring is correct. Incorrect wiring may cause explosion or fire.
5. If the power supply is connected directly without a load, the internal elements may explode or burn.
6. Be sure to insert a load when connecting the power supply.

Precautions for Correct Use

Do not use the product in any atmosphere or environment that exceeds the ratings.

Operating Environment

1. Do not install the Sensor in the following locations.
 - (1) Outdoor locations directly subject to sunlight, rain, snow, water droplets, or oil.
 - (2) Locations subject to atmospheres with chemical vapors, in particular solvents and acids.
 - (3) Locations subject to corrosive gases.
2. The Sensor may malfunction if used near ultrasonic cleaning equipment, high-frequency equipment, transceivers, cellular phones, inverters, or other devices that generate a high-frequency electric field. Please refer to the Precautions for Correct Use on the OMRON website (www.ia.omron.com) for typical measures.
3. Laying the Proximity Sensor wiring in the same conduit or duct as high-voltage wires or power lines may result in incorrect operation and damage due to induction. Wire the Sensor using a separate conduit or independent conduit.
4. Never use thinner or other solvents. Otherwise, the Sensor surface may be dissolved.
5. The following conditions shall be observed if you use the product under an environment using cutting oil that may affect product's life and/or performance.
 - Usage under the cutting oil condition designated by the specification
 - Usage under the cutting oil dilution ratio recommended by its manufacturer
 - Usage in oil or water is prohibited
 Impact on the product life may differ depending on the oil you use. Before using the cutting oil, make sure that it should not cause deterioration or degradation of sealing components.
6. When turning on the power by influence of temperature environment, an output mis-pulse sometimes occurs. After the sensor has passed for 300 msec after turning on, please use in the stable state. (DC 3-wire only.)
7. The sensor is adjusted with a high degree of accuracy, so do not use in the environment with sudden temperature change. (DC 3-wire only.)
8. Operation check is performed using an OMRON's IO-Link master. If using an IO-Link master from another company, perform the operation check in advance. (Models with IO-Link only.)
9. In the IO-Link mode, the cord between the IO-Link master and sensor must have a length of 20 m or less. (Models with IO-Link only.)

AND Connection of Proximity Sensors (DC 2-wire)

Two or more sensors cannot be connected in series on the AND circuit. Use them via a relay as shown on the figure.

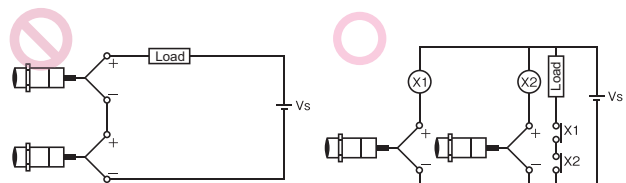

OR Wiring of Proximity Sensors (DC 2-wire)

As a general principle, two or more sensors cannot be used in parallel on the OR circuit. It is possible only when sensors do not operate simultaneously and loads do not need to be maintained. When loads need to be maintained, use the sensors via a relay as shown on the figure.

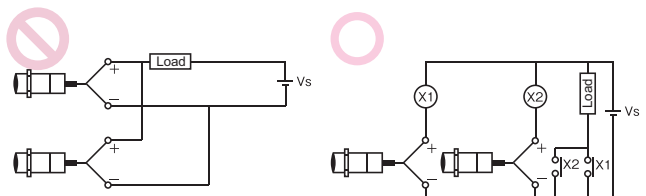

Design

Influence of Surrounding Metal

When mounting the Proximity Sensor using a nut, only use the provided nut. And ensure that the minimum distances given in the following table are maintained.

When mounting the Proximity Sensor using a nut, only use the provided nut. Nuts that are supplied along with each Sensor are different. Refer to Dimensions for details on shapes.

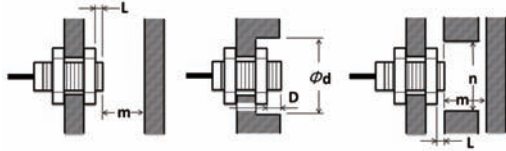

(Unit: mm)

Type	Model	L	d	D	m	n
DC 2-wire Spatter-resistant Triple distance model	E2EQ-X3D□8	0	20	2	9	18
	E2EQ-X7D□12	0	20	4	18	20
	E2EQ-X11D□18	0	50	4	33	54
	E2EQ-X20D□30	0	70	8	60	90
DC 3-wire Spatter-resistant Triple distance model	E2EQ-X3□8	0	20	0	9	18
	E2EQ-X6□12	0	20	0	18	20
	E2EQ-X12□18	0	50	0	36	54
	E2EQ-X22□30	0	70	0	66	90
DC 2-wire/DC 3-wire Spatter-resistant Double distance model	E2EQ-X2□8	0	8	0	4.5	12
	E2EQ-X4□12	0	18	0	12	18
	E2EQ-X8□18	0	27	0	24	27
	E2EQ-X15□30	0	45	0	45	45
DC 3-wire Spatter-resistant Single distance model	E2EQ-X1R5□8	0	8	0	4.5	12
	E2EQ-X2□12	0	12	0	8	18
	E2EQ-X5□18	0	18	0	20	27
	E2EQ-X10□30	0	30	0	40	45

When the Proximity Sensor is mounted in metal, ensure that the minimum distances given in the following table are maintained.

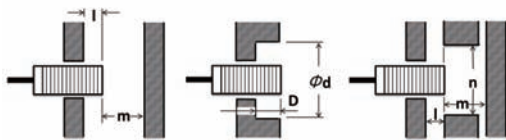

(Unit: mm)

Models	Model	l	d	D	m	n
DC 2-wire Spatter-resistant Triple distance model	E2EQ-X3D□8	2	20	2	9	18
	E2EQ-X7D□12	4	20	4	18	20
	E2EQ-X11D□18	4	50	4	33	54
	E2EQ-X20D□30	8	70	8	60	90
DC 3-wire Spatter-resistant Triple distance model	E2EQ-X3□8	2	20	2	9	18
	E2EQ-X6□12	4	20	4	18	20
	E2EQ-X12□18	4	50	4	36	54
	E2EQ-X22□30	8	70	8	66	90
DC 2-wire/DC 3-wire Spatter-resistant Double distance model	E2EQ-X2□8	0	8	0	4.5	12
	E2EQ-X4□12	2.4	18	2.4	12	18
	E2EQ-X8□18	3.6	27	3.6	24	27
	E2EQ-X15□30	6	45	6	45	45
DC 3-wire Spatter-resistant Single distance model	E2EQ-X1R5□8	0	8	0	4.5	12
	E2EQ-X2□12	0	12	0	8	18
	E2EQ-X5□18	0	18	0	20	27
	E2EQ-X10□30	0	30	0	40	45

Mutual Interference

When installing two or more Proximity Sensors face-to-face or side-by-side, ensure that the minimum distances given in the following table are maintained.

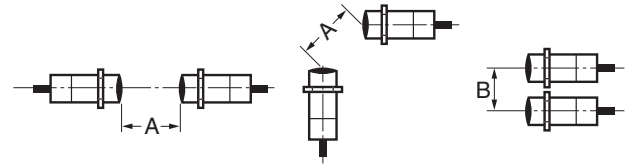

(Unit: mm)

Models	Model	Item	
		A	B
DC 2-wire Spatter-resistant Triple distance model	E2EQ-X3D□8	25	20
	E2EQ-X7D□12	40	30
	E2EQ-X11D□18	70	45
	E2EQ-X20D□30	140	70
DC 3-wire Spatter-resistant Triple distance model	E2EQ-X3□8	25	20
	E2EQ-X6□12	40	30
	E2EQ-X12□18	70	45
	E2EQ-X22□30	150	90
DC 2-wire/DC 3-wire Spatter-resistant Double distance model	E2EQ-X2□8	20	15
	E2EQ-X4□12	30	20
	E2EQ-X8□18	60	35
	E2EQ-X15□30	110	90
DC 3-wire Spatter-resistant Single distance model	E2EQ-X1R5□8	20	15
	E2EQ-X2□12	30	20
	E2EQ-X5□18	50	35
	E2EQ-X10□30	100	70

Mounting

Tightening Force

Do not tighten the nut with excessive force. A washer must be used with the nut.

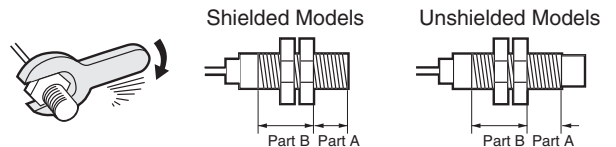

- Note: 1.** The allowable tightening strength depends on the distance from the edge of the head, as shown in the following table. (A is the distance from the edge of the head. B includes the nut on the head side. If the edge of the nut is in part A, the tightening torque for part A applies instead.)
- 2.** The following strengths assume washers are being used.

DC 2-wire/DC 3-wire Spatter-resistant Triple distance model

Size	Part A		Part B
	Dimension (mm)	Torque	Torque
M8	9	4 N·m	10 N·m
M12	16	8 N·m	15 N·m
M18	16	15 N·m	30 N·m
M30	23	40 N·m	80 N·m

DC 2-wire/DC 3-wire Spatter-resistant Double distance model, Spatter-resistant Single distance model

Size	Part A		Part B
	Dimension (mm)	Torque	Torque
M8	9	9 N·m	12 N·m
M12	---	---	30 N·m
M18	---	---	70 N·m
M30	---	---	100 N·m

E2EQ NEXT Series

Dimensions

(Unit: mm)

Tolerance class IT16 applies to dimensions in this data sheet unless otherwise specified.

Sensors

BASIC Model

E2EQ NEXT Series (Spatter-resistant, Double distance/Single distance model)

DC 2-wire/DC 3-wire

Pre-wired Model/Pre-wired Connector Model

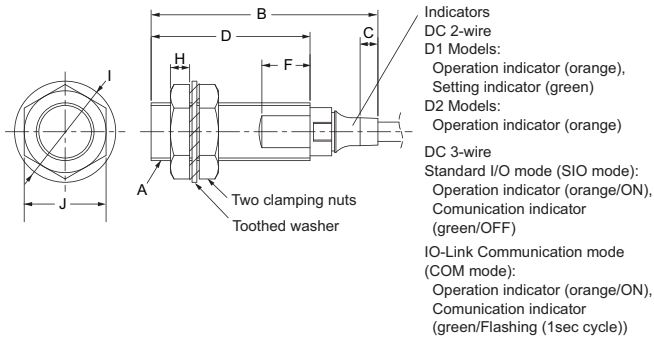

Pre-wired Models



Operation mode, Output configuration (D1: NO, D2: NC)
Vinyl-insulated round cable with 2 conductors
M8, M12 size: 4-dia.
(Conductor cross section: 0.3 mm² (AWG23), Insulator diameter: 1.15 mm),
M18, M30 size: 6-dia.
(Conductor cross section: 0.5 mm² (AWG20), Insulator diameter: 1.5 mm),
Standard length: 2 m (Pre-wired Models), 0.3 m (Pre-wired Connector Models)

Operation mode, Output configuration (B1/C1: NO, B2/C2: NC)
Vinyl-insulated round cable with 3 conductors
M8, M12 size: 4-dia.
M18, M30 size: 6-dia.
(Conductor cross section: 0.2 mm² (AWG24), Insulator diameter: 1.5 mm),
Standard length: 2 m (Pre-wired Models), 0.3 m (Pre-wired Connector Models)

Operation mode, Output configuration (B3/C3: NO+NC Type)
Vinyl-insulated round cable with 4 conductors
M8, M12 size: 4.3-dia.
M18, M30 size: 6-dia.
(Conductor cross section: 0.2 mm² (AWG24), Insulator diameter: 1.5 mm),
Standard length: 2 m (Pre-wired Models), 0.3 m (Pre-wired Connector Models)

Model	A	B	C	D	F	H	I	J
E2EQ-X□8	M8XP1	37.8	4.4	26	8	3	15	13
E2EQ-X□12	M12XP1	47.1	3.7	33	10	4	21	17
E2EQ-X□18	M18XP1	55.3	8.5	38	10	4	29	24
E2EQ-X□30	M30XP1.5	60.3	8.3	43	10	5	42	36

Connector Models

(M12 Connector, M8 (4-pin) Connector and M8 (3-pin) Connector)

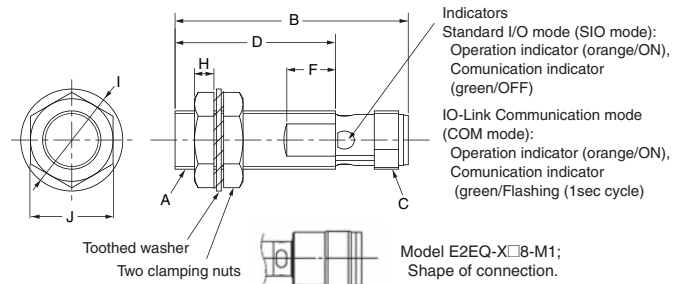

Model	A	B	C	D	F	H	I	J
E2EQ-X□8-M3/M5	M8XP1	39	M8XP1	26	8	3	15	13
E2EQ-X□8-M1	M8XP1	43	M12XP1	26	8	3	15	13
E2EQ-X□12-M1	M12XP1	48	M12XP1	33	10	4	21	17
E2EQ-X□18-M1	M18XP1	53	M12XP1	38	10	4	29	24
E2EQ-X□30-M1	M30XP1.5	58	M12XP1	43	10	5	42	36

Mounting Hole Dimensions



Dimensions	F (mm)
M8	8.5 dia. $+0.5$ ₀
M12	12.5 dia. $+0.5$ ₀
M18	18.5 dia. $+0.5$ ₀
M30	30.5 dia. $+0.5$ ₀

Angle R of the Bending Wire



Dimensions	R (mm)
M8	12
M12	
M18	
M30	18

Wire pullout position



Dimensions	Sc (mm)
M8	- (0)
M12	
M18	
M30	2.5

PREMIUM Model

**E2EQ NEXT Series (Spatter-resistant, Triple distance model)
DC 2-wire/DC 3-wire**

Pre-wired Model/Pre-wired Connector Model



Connector Models

(M12 Connector, M8 (4-pin) Connector and M8 (3-pin) Connector)



Note: DC 3-wire only

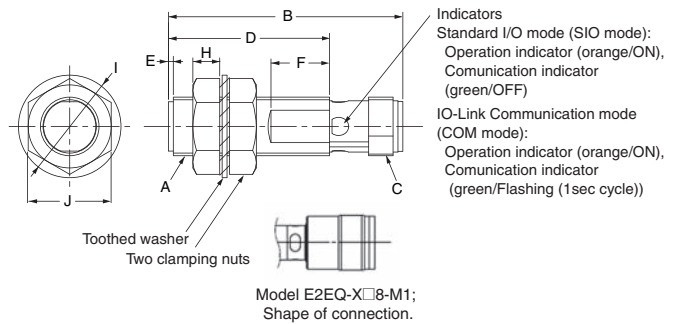
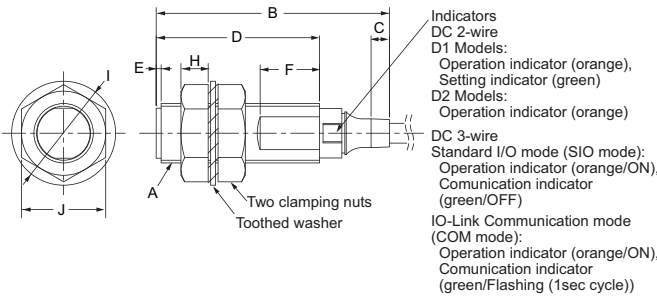

Pre-wired Models

**Pre-wired Connector Models
(M1TJ/M1TGJ)**



Operation mode, Output configuration (D1: NO, D2: NC)
Vinyl-insulated round cable with 2 conductors
M8, M12 size: 4-dia.
(Conductor cross section: 0.3 mm² (AWG23), Insulator diameter: 1.15 mm),
M18, M30 size: 6-dia.
(Conductor cross section: 0.5 mm² (AWG20), Insulator diameter: 1.5 mm),
Standard length: 2 m (Pre-wired Models), 0.3 m (Pre-wired Connector Models)

Operation mode, Output configuration (B1/C1: NO, B2/C2: NC)
Vinyl-insulated round cable with 3 conductors
M8, M12 size: 4-dia.
M18, M30 size: 6-dia.
(Conductor cross section: 0.2 mm² (AWG24), Insulator diameter: 1.5 mm),
Standard length: 2 m (Pre-wired Models), 0.3 m (Pre-wired Connector Models)

Operation mode, Output configuration (B3/C3: NO+NC Type)
Vinyl-insulated round cable with 4 conductors
M8, M12 size: 4.3-dia.
M18, M30 size: 6-dia.
(Conductor cross section: 0.2 mm² (AWG24), Insulator diameter: 1.5 mm),
Standard length: 2 m (Pre-wired Models), 0.3 m (Pre-wired Connector Models)

Model	A	B	C	D	E	F	H	I	J
E2EQ-X□8-M3/M5	M8XP1	39	M8XP1	26	1	10	4	15	13
E2EQ-X□8-M1	M8XP1	43	M12XP1	26	1	10	4	15	13
E2EQ-X□12-M1	M12XP1	48	M12XP1	33	1	12	5.5	21	17
E2EQ-X□18-M1	M18XP1	53	M12XP1	38	1	12	6	29	24
E2EQ-X□30-M1	M30XP1.5	58	M12XP1	43	1	12	7	42	36

Model	A	B	C	D	E	F	H	I	J
E2EQ-X□□8	M8XP1	37.8	4.4	26	1	10 (8*)	4	15	13
E2EQ-X□□12	M12XP1	47.1	3.7	33	1	12 (10*)	5.5	21	17
E2EQ-X□□18	M18XP1	55.3	8.5	38	1	12	6	29	24
E2EQ-X□□30	M30XP1.5	60.3	8.3	43	1	12	7	42	36

* If using the E2EQ-X□□8, E2EQ-X□□12, refer to () dimensions.

Mounting Hole Dimensions



Dimensions	F (mm)
M8	8.5 dia. ^{+0.5} / ₀
M12	12.5 dia. ^{+0.5} / ₀
M18	18.5 dia. ^{+0.5} / ₀
M30	30.5 dia. ^{+0.5} / ₀

Angle R of the Bending Wire

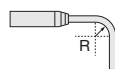

Dimensions	R (mm)
M8	12
M12	
M18	18
M30	

Wire pullout position

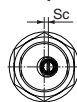

Dimensions	Sc (mm)
M8	- (0)
M12	
M18	
M30	2.5

E2EQ

Spatter-resistant Fluororesin-coated Proximity Sensor

- Superior spatter resistance.
- Pre-wired Smartclick Connector Models are also available.



For the most recent information on models that have been certified for safety standards, refer to your OMRON website.

Be sure to read *Safety Precautions* on page 67.

Ordering Information

Sensors [Refer to *Dimensions* on page 68.]

Pre-wired Models

Long Sensing-distance Models

Appearance		Sensing distance		Output configuration	Operation mode	Model
Shielded 	M12	4 mm		DC 2-wire (no polarity)	NO	E2EQ-X4X1 2M *1
	M18	8 mm				E2EQ-X8X1 2M *1
	M30	15 mm				E2EQ-X15X1 2M *1

Standard Models

Appearance		Sensing distance		Output configuration	Operation mode	Model
Shielded 	M12	3 mm		DC 2-wire	NO	E2EQ-X3D1 2M
	M18	7 mm				E2EQ-X7D1 2M
	M30	10 mm				E2EQ-X10D1 2M

Pre-wired Smartclick Connector Models (M12)

Long Sensing-distance Models

Appearance		Sensing distance		Output configuration	Operation mode	Model
Shielded 	M12	4 mm		DC 2-wire (no polarity) (3)-(4) pin arrangement	NO	E2EQ-X4X1-M1TJ 0.3M *1
	M18	8 mm				E2EQ-X8X1-M1TJ 0.3M *1
	M30	15 mm				E2EQ-X15X1-M1TJ 0.3M *1

Standard Models

Standard Models		Sensing distance		Output configuration	Operation mode	Model
Shielded 	M12	3 mm		DC 2-wire (1)-(4) pin arrangement	NO	E2EQ-X3D1-M1TGJ 0.3M
	M18	7 mm				E2EQ-X7D1-M1TGJ 0.3M
	M30	10 mm				E2EQ-X10D1-M1TGJ 0.3M

Pre-wired Connector Models (M12)

Long Sensing-distance Models

Appearance		Sensing distance		Output configuration	Operation mode	Model
Shielded 	M12	4 mm		DC 2-wire (without polarity) (3)-(4) pin arrangement	NO	E2EQ-X4X1-M1J 0.3M *1
	M18	8 mm				E2EQ-X8X1-M1J 0.3M *1
	M30	15 mm				E2EQ-X15X1-M1J 0.3M *1

Standard Models

Standard Models		Sensing distance		Output configuration	Operation mode	Model
Shielded 	M12	3 mm		DC 2-wire (1)-(4) pin arrangement	NO	E2EQ-X3D1-M1GJ 0.3M
	M18	7 mm				E2EQ-X7D1-M1GJ 0.3M
	M30	10 mm				E2EQ-X10D1-M1GJ 0.3M

*1. Orders will be accepted until the end of March 2024.

Sensor I/O Connectors (Sold Separately)

For details of the connector, refer to XS5 Series on page 70.

Ratings and Specifications

Long Sensing-distance Models

Model		E2EQ-X4X1 E2EQ-X4X1-M1(T)J	E2EQ-X8X1 E2EQ-X8X1-M1(T)J	E2EQ-X15X1 E2EQ-X15X1-M1(T)J
Item				
Sensing distance		4 mm ±10%	8 mm ±10%	15 mm ±10%
Set distance *1		0 to 3.2 mm	0 to 6.4 mm	0 to 12 mm
Differential travel		15% max. of sensing distance		
Standard sensing object		Iron, 12 × 12 × 1 mm	Iron, 18 × 18 × 1 mm	Iron, 30 × 30 × 1 mm
Response frequency *2		1 kHz	0.5 kHz	0.25 kHz
Control output	Load current	3 to 100 mA		
	Residual voltage *3	5 V max. (Load current: 100 mA, Cable length: 2 m)		
Operation mode (with sensing object approaching)		Load ON: NO; For details, refer to the timing charts on page 67.		
Protection circuits		Load short-circuit protection, Surge suppressor		
Ambient temperature range		Operating: -25 to 70°C, Storage: -40 to 85°C, (with no icing or condensation)		
Temperature influence		±15% max. of sensing distance at 23°C in the temperature range of -25 to 70°C		±15% max. of sensing distance at 23°C in the temperature range of -25 to 70°C
Voltage influence		±1% max. of sensing distance at rated voltage in the rated voltage ±15% range		
Shock resistance		Destruction: 1,000m/s ² 10 times each in X, Y, and Z directions		
Connection method		Pre-wired Models (Standard cable length: 2 m), Pre-wired Connector Models		
Weight (packed state)	Pre-wired Models	Approx. 65 g	Approx. 140 g	Approx. 190 g
	Pre-wired Connector Models	Approx. 20 g	Approx. 40 g	Approx. 90 g

Standard Models

Model		E2EQ-X3D1 E2EQ-X3D1-M1(T)GJ	E2EQ-X7D1 E2EQ-X7D1-M1(T)GJ	E2EQ-X10D1 E2EQ-X10D1-M1(T)GJ
Item				
Sensing distance		3 mm ±10%	7 mm ±10%	10 mm ±10%
Set distance		0 to 2.4 mm	0 to 5.6 mm	0 to 8 mm
Differential travel		10% max. of sensing distance		
Standard sensing object		Iron, 12 × 12 × 1 mm	Iron, 18 × 18 × 1 mm	Iron, 30 × 30 × 1 mm
Response frequency *4		1 kHz	500 Hz	400 Hz
Control output	Load current	3 to 100 mA		
	Residual voltage	3 V max. (Load current: 100 mA, Cable length: 2 m)		
Operation mode (with sensing object approaching)		Load ON: NO; For details, refer to the timing charts on page 67.		
Protection circuits		Load short-circuit protection, Surge suppressor		
Ambient temperature range		Operating/Storage: -25 to 70°C (with no icing or condensation)		
Temperature influence		±10% max. of sensing distance at 23°C in the temperature range of -25 to 70°C		
Voltage influence		±2.5% max. of sensing distance at rated voltage in the rated voltage ±15% range		
Shock resistance		Destruction: 1,000 m/s ² 10 times each in X, Y, and Z directions		
Connection method		E2EQ-X□D1: Pre-wired Models (Standard cable length: 2 m) E2EQ-X□D1-M1GJ: Pre-wired Connector Models (Standard cable length: 300mm)		
Weight (packed state)	Pre-wired Models	Approx. 120 g	Approx. 160 g	Approx. 220 g
	Pre-wired Connector Models	Approx. 80 g	Approx. 110 g	Approx. 190 g

Common Ratings and Performance

Model		E2EQ-X4X1 E2EQ-X4X1-M1(T)J E2EQ-X3D1 E2EQ-X3D1-M1(T)GJ	E2EQ-X8X1 E2EQ-X8X1-M1(T)J E2EQ-X7D1 E2EQ-X7D1-M1(T)GJ	E2EQ-X15X1 E2EQ-X15X1-M1(T)J E2EQ-X10D1 E2EQ-X10D1-M1(T)GJ
Item				
Detectable object		Ferrous metal (The sensing distance decreases with non-ferrous metal. Refer to <i>Engineering Data</i> on page 66.)		
Power supply voltage (operating voltage range)		12 to 24 VDC (10 to 30 VDC), ripple (p-p): 10% max.		
Leakage current		0.8 mA max.		
Indicators		Operation indicator (red), Setting indicator (green)		
Ambient humidity range		Operating/Storage: 35% to 95% (with no condensation)		
Insulation resistance		50 MΩ min. (at 500 VDC) between current-carrying parts and case		
Dielectric strength		1,000 VAC for 1 min between current-carrying parts and case		
Vibration resistance		Destruction: 10 to 55 Hz, 1.5-mm double amplitude for 2 hours each in X, Y, and Z directions		
Degree of protection		IEC 60529 IP67, in-house standards: oil-resistant		
Materials	Case	Fluororesin coating (Base material: brass)		
	Sensing surface	Fluororesin		
	Clamping nuts	Fluororesin coating (Base material: brass)		
	Toothed washer	Zinc-plated iron		
Accessories		Instruction manual		

*1. Use the Sensor within the range in which the green indicator is ON.

*2. The response frequency is an average value.

*3. The residual voltage is 5 V. Make sure that the device connected to the Sensor can withstand the residual voltage.

*4. The response frequency is an average value. Measurement conditions are as follows: standard sensing object, a distance of twice the standard sensing object, and a set distance of half the sensing distance.

E2EQ

Engineering Data (Reference Value)

Sensing Area

E2EQ-X□X□(-M1(T)J)

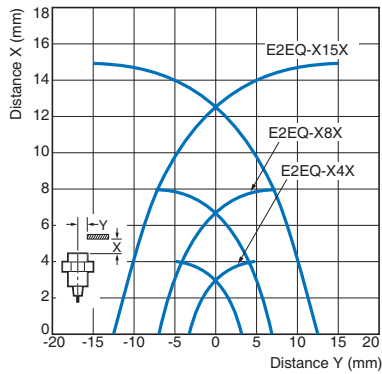

E2EQ-X□D□(-M1(T)GJ)

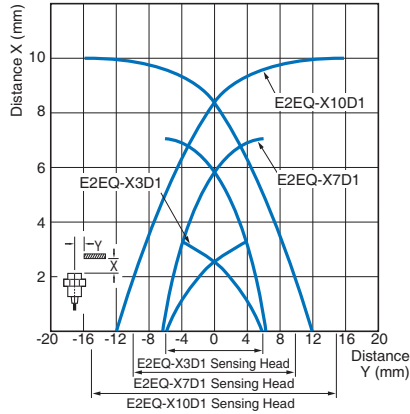

Influence of Sensing Object Size and Material

E2EQ-X4X1(-M1(T)J)

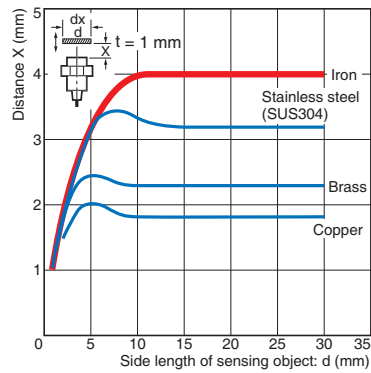

E2EQ-X8X1(-M1(T)J)

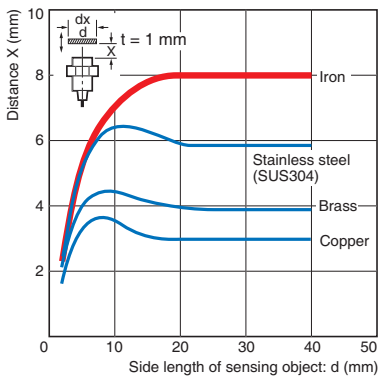

E2EQ-X15X1(-M1(T)J)

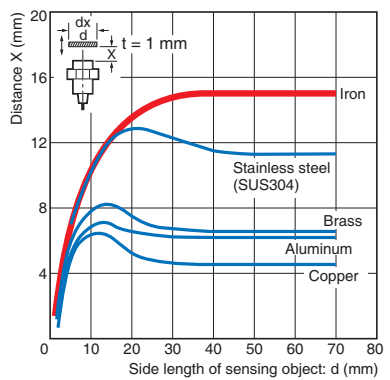

E2EQ-X3D1(-M1(T)GJ)

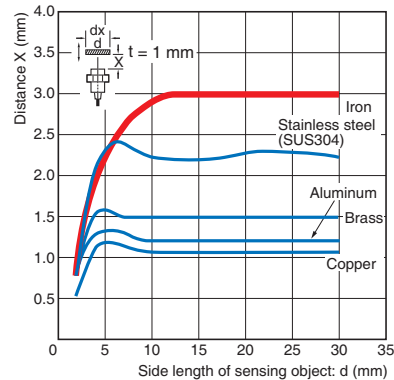

E2EQ-X7D1(-M1(T)GJ)

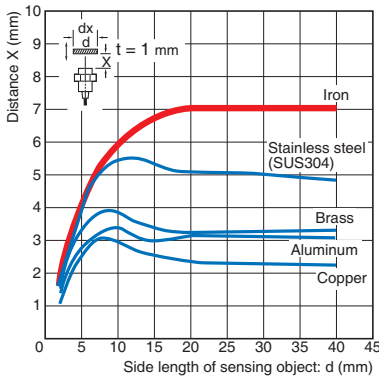

E2EQ-X10D1(-M1(T)GJ)

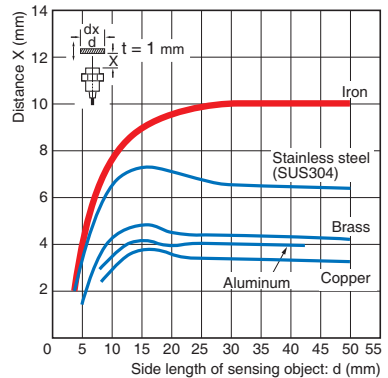

Residual Output Voltage

E2EQ-X□X□(-M1(T)J)

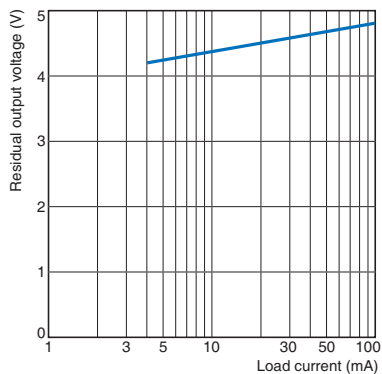

E2EQ-X□D□(-M1(T)GJ)

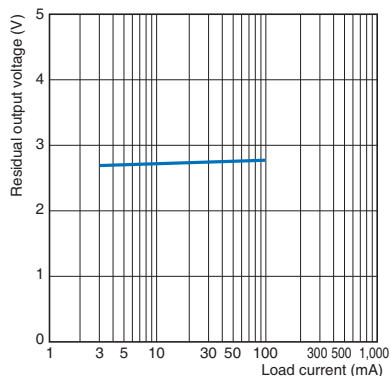

Leakage Current

E2EQ-X□D

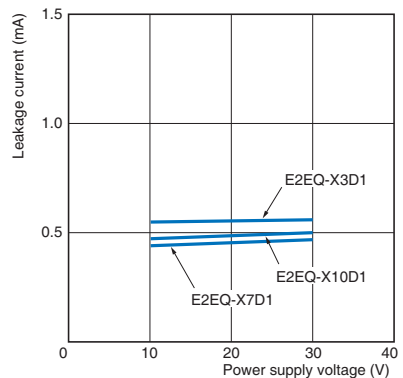

I/O Circuit Diagrams

Long Sensing-distance Models

Model	Operation mode	Timing Chart	Output circuit
E2EQ-X4X1 E2EQ-X8X1 E2EQ-X15X1 E2EQ-X4X1-M1(T)J E2EQ-X8X1-M1(T)J E2EQ-X15X1-M1(T)J	NO		<p>Note 1. The load can be connected to either the +V or 0 V side. Note 2. There is no polarity. Therefore, the brown and blue lines have no polarity.</p>

Standard Models

Model	Operation mode	Timing Chart	Output circuit
E2EQ-X3D1 E2EQ-X7D1 E2EQ-X10D1 E2EQ-X3D1-M1(T)GJ E2EQ-X7D1-M1(T)GJ E2EQ-X10D1-M1(T)GJ	NO		<p>Note: The load can be connected to either the +V or 0 V side.</p>

Safety Precautions

Refer to *Warranty and Limitations of Liability*.

⚠ WARNING

This product is not designed or rated for ensuring safety of persons either directly or indirectly. Do not use it for such purposes.

Precautions for Correct Use

Do not use this product under ambient conditions that exceed the ratings.

Design

Influence of Surrounding Metal

When mounting the Sensor within a metal panel, ensure that the clearances given in the following table are maintained. Failure to maintain these distances may cause deterioration in the performance of the Sensor.

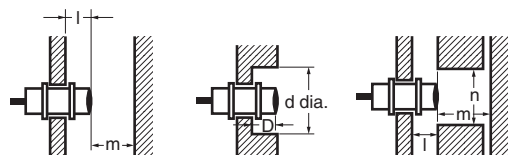

Influence of Surrounding Metal (Unit: mm)

Model	Item	l	d	D	m	n
E2EQ-X4X1(-M1(T)J)		2.4	18	2.4	12	18
E2EQ-X8X1(-M1(T)J)		3.6	27	3.6	24	27
E2EQ-X15X1(-M1(T)J)		6	45	6	45	45
E2EQ-X3D1(-M1(T)GJ)			12		8	18
E2EQ-X7D1(-M1(T)GJ)		0	18	0	20	27
E2EQ-X10D1(-M1(T)GJ)			30		40	45

Mutual Interference

When installing two or more Sensors face-to-face or side-by-side, ensure that the minimum distances given in the following table are maintained.

Mutual Interference (Unit: mm)

Model	Item	A	B
E2EQ-X4X1(-M1(T)J)		30	20
E2EQ-X8X1(-M1(T)J)		60	35
E2EQ-X15X1(-M1(T)J)		110	90
E2EQ-X3D1(-M1(T)GJ)		30	20
E2EQ-X7D1(-M1(T)GJ)		50	35
E2EQ-X10D1(-M1(T)GJ)		100	70

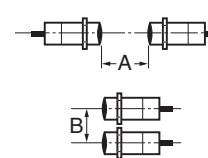

Mounting

Do not tighten the nut with excessive force. A washer must be used with the nut.

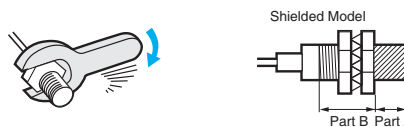

Note: 1. The allowable tightening strength depends on the distance from the edge of the head, as shown in the following table. (A is the distance from the edge of the head. B includes the nut on the head side. If the edge of the nut is in part A, the tightening torque for part A applies instead.)
2. The following torque assume washers are being used.

Model	Torque	Part	
		Part A	Part B
		Dimension (mm)	Torque
E2EQ-X4X1(-M1(T)J)	---	---	30 N·m
E2EQ-X8X1(-M1(T)J)			70 N·m
E2EQ-X15X1(-M1(T)J)			180 N·m
E2EQ-X3D1(-M1(T)GJ)	24	15 N·m	---
E2EQ-X7D1(-M1(T)GJ)	29		
E2EQ-X10D1(-M1(T)GJ)	26		

E2EQ

Dimensions

(Unit: mm)
Tolerance class IT16 applies to dimensions in this data sheet unless otherwise specified.

Pre-wired Models

Long Sensing-distance Models

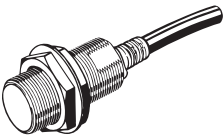

E2EQ-X4X1

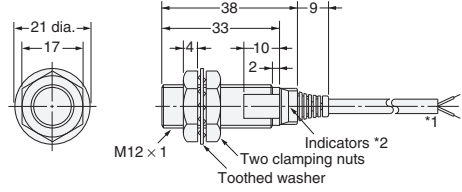

*1. 4-dia. vinyl-insulated round cable with 2 conductors (Flame-resistant, Conductor cross section: 0.3 mm², Insulator diameter: 1.3 mm), Standard length: 2 m
The cable can be extended up to 200 m (separate metal conduit).

*2. Operation indicator (red), Setting indicator (green)

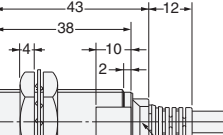

E2EQ-X8X1

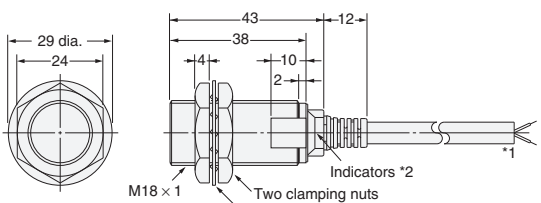

*1. 6-dia. vinyl-insulated round cable with 2 conductors (Flame-resistant, Conductor cross section: 0.5 mm², Insulator diameter: 1.9 mm), Standard length: 2 m
The cable can be extended up to 200 m (separate metal conduit).

*2. Operation indicator (red), Setting indicator (green)

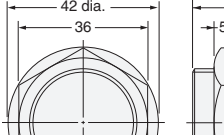

E2EQ-X15X1

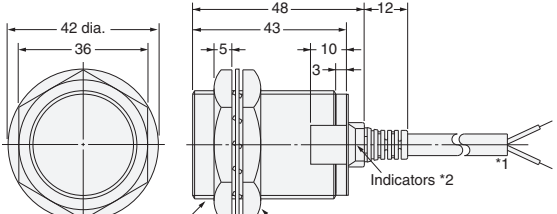

*1. 6-dia. vinyl-insulated round cable with 2 conductors (Flame-resistant, Conductor cross section: 0.5 mm², Insulator diameter: 1.9 mm), Standard length: 2 m
The cable can be extended up to 200 m (separate metal conduit).

*2. Operation indicator (red), Setting indicator (green)

Standard Models

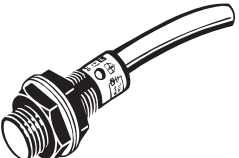

E2EQ-X3D1

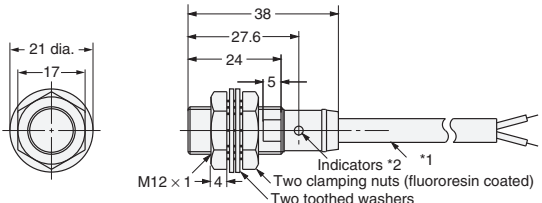

*1. 6-dia. vinyl-insulated round cable with 2 conductors (Flame-resistant, Conductor cross section: 0.5 mm², Insulator diameter: 1.9 mm), Standard length: 2 m
The cable can be extended up to 200 m (separate metal conduit).

*2. Operation indicator (red), Setting indicator (green)

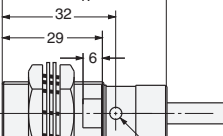

E2EQ-X7D1

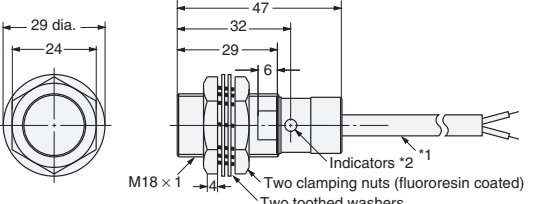

*1. 6-dia. vinyl-insulated round cable with 2 conductors (Flame-resistant, Conductor cross section: 0.5 mm², Insulator diameter: 1.9 mm), Standard length: 2 m
The cable can be extended up to 200 m (separate metal conduit).

*2. Operation indicator (red), Setting indicator (green)

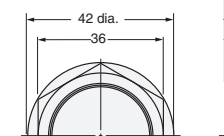

E2EQ-X10D1

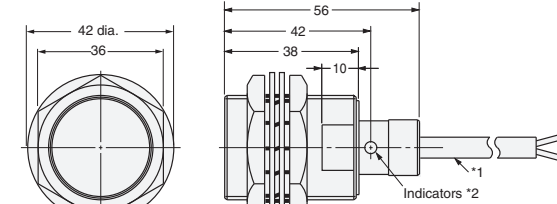

*1. 6-dia. vinyl-insulated round cable with 2 conductors (Flame-resistant, Conductor cross section: 0.5 mm², Insulator diameter: 1.9 mm), Standard length: 2 m
The cable can be extended up to 200 m (separate metal conduit).

*2. Operation indicator (red), Setting indicator (green)

Pre-wired Connector Models
Long Sensing-distance Models

E2EW Series

E2EF/E2FM Series

E2EQ NEXT Series

E2EQ Series

X55 Series

E2EQ-X4X1-M1(T)J



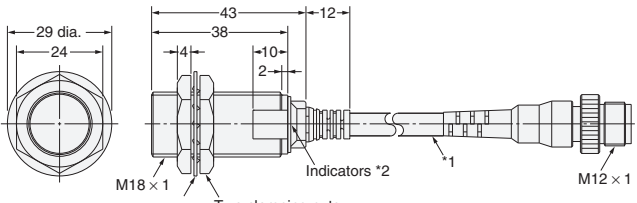

*1. 4-dia. vinyl-insulated round cable (Flame-resistant, Conductor cross section: 0.3 mm², Insulator diameter: 1.3 mm), Standard length: 300 mm
 *2. Operation indicator (red), Setting indicator (green)

E2EQ-X8X1-M1(T)J

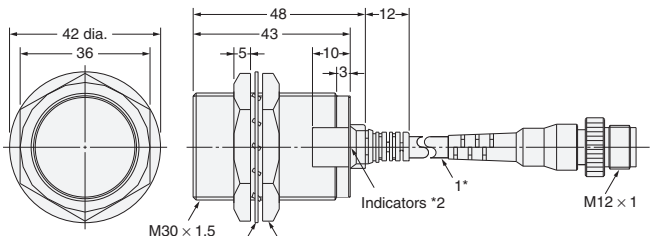

*1. 6-dia. vinyl-insulated round cable (Flame-resistant, Conductor cross section: 0.5 mm², Insulator diameter: 1.9 mm), Standard length: 300 mm
 *2. Operation indicator (red), Setting indicator (green)

E2EQ-X15X1-M1(T)J



*1. 6-dia. vinyl-insulated round cable (Flame-resistant, Conductor cross section: 0.5 mm², Insulator diameter: 1.9 mm), Standard length: 300 mm
 *2. Operation indicator (red), Setting indicator (green)

Standard Models

E2EQ-X3D1-M1(T)GJ

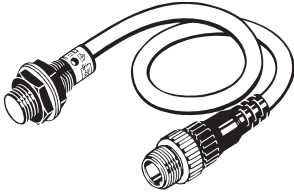
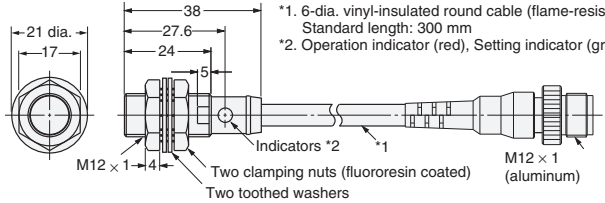
*1. 6-dia. vinyl-insulated round cable (flame-resistant), Standard length: 300 mm
 *2. Operation indicator (red), Setting indicator (green)

E2EQ-X7D1-M1(T)GJ

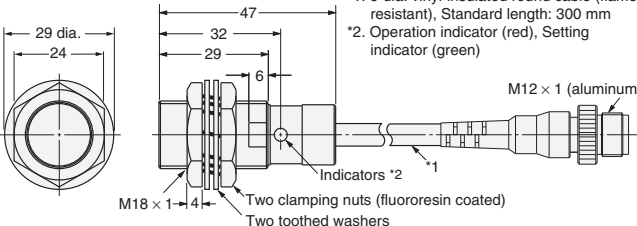

*1. 6-dia. vinyl-insulated round cable (flame-resistant), Standard length: 300 mm
 *2. Operation indicator (red), Setting indicator (green)

E2EQ-X10D1-M1(T)GJ

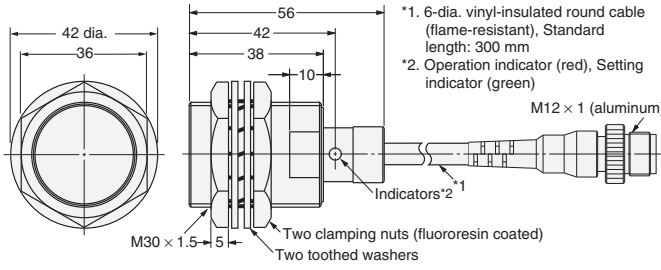

*1. 6-dia. vinyl-insulated round cable (flame-resistant), Standard length: 300 mm
 *2. Operation indicator (red), Setting indicator (green)

Mounting Hole Dimensions

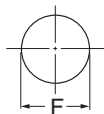

Model	E2EQ-X4X□ E2EQ-X3□	E2EQ-X8X□ E2EQ-X7□	E2EQ-X15X□ E2EQ-X10□
F (mm)	12.5 ^{+0.5} ₀ dia.	18.5 ^{+0.5} ₀ dia.	30.5 ^{+0.5} ₀ dia.

Round Water-resistant Connectors (M12 Smartclick)

XS5

Round Water-resistive Smartclick Connectors that Reduce Installation Work

- A newly developed lock mechanism that is compatible with round M12 connectors.
- Simply insert the Connectors, then turn them approximately 1/8 of a turn to lock.
- A positive click indicates locking.
- Spatter-resistant Cables are also available.
- IP67 degree of protection.
- UL approved products.





For the most recent information on models that have been certified for safety standards, refer to your OMRON website.

Note: For details, refer to XS5 on your OMRON website.

Ordering Information

Sensor I/O Connectors

A Sensor I/O Connector is not provided with the Sensor. It must be ordered separately as required.

Appearance	Cable Specification	Type	Cable diameter (mm)	Cable Connection Direction	Cable length (m)	Sensor I/O Connector model number	Applicable Proximity Sensor model number
M12 Smartclick Connector Straight type  Right-angle type 	PVC robot cable	Sockets on One Cable End	6 dia.	Straight	1	XS5F-D421-C80-F	E2EW, E2E NEXT, E2EF, E2FM (M12 Pre-wired Smartclick Connector, M12 Connector)
					2	XS5F-D421-D80-F	
					3	XS5F-D421-E80-F	
					5	XS5F-D421-G80-F	
					10	XS5F-D421-J80-F	
				Right-angle	1	XS5F-D422-C80-F	
					2	XS5F-D422-D80-F	
					3	XS5F-D422-E80-F	
					5	XS5F-D422-G80-F	
					10	XS5F-D422-J80-F	
	Socket and Plug on Cable Ends	6 dia.	Straight (Socket)/ Straight (Plug)	1	XS5W-D421-C81-F		
				2	XS5W-D421-D81-F		
				3	XS5W-D421-E81-F		
				5	XS5W-D421-G81-F		
			Right-angle (Socket)/ Right-angle (Plug)	10	XS5W-D421-J81-F		
				2	XS5W-D422-D81-F		
				5	XS5W-D422-G81-F		
				Straight (Socket)/ Right-angle (Plug)	2	XS5W-D423-D81-F	
5	XS5W-D423-G81-F						
Right-angle (Socket)/ Straight (Plug)	2	XS5W-D424-D81-F					
	5	XS5W-D424-G81-F					
Spatter-resistant Cable	Sockets on One Cable End	6.6 dia.	Straight	2	XS5F-D421-D80-SA		
				5	XS5F-D421-G80-SA		
	Socket and Plug on Cable Ends	6.6 dia.	Straight (Socket)/ Straight (Plug)	2	XS5W-D421-D81-SA		
				5	XS5W-D421-G81-SA		

Connections for Sensor I/O Connectors

DC 2-Wire

Proximity Sensor				Sensor I/O Connectors	
Type	Polarity	Operation mode	Model	Model	Connections *1
DC 2-Wire (Smartclick Connector)	Yes	NO	E2EW-(Q)X□D1□-M1TGJ E2EQ-X□D1□-M1TGJ E2EF-(Q)X□D1-M1TGJ E2FM-X□D1-M1TGJ	XS5F-D42□-□80-F XS5F-D421-□80-SA XS5W-D42□-□81-F XS5W-D421-□81-SA	
		NC	E2EQ-X□D2□-M1TGJ		
	No	NO	E2EW-(Q)X□D1□-M1TGJ-T E2EQ-X□D1□-M1TGJ-T		
		NC	E2EQ-X□D2□-M1TGJ-T		

DC 3-Wire

Proximity Sensor				Sensor I/O Connectors	
Types	Output	Operation mode	Model	Model	Connections *1
DC 3-Wire (M12 Connector / M12 Smartclick Connector)	PNP	NO	E2EW-(Q)X□B1□-M1TJ/M1 E2EQ-X□B1□-M1TJ/M1	XS5F-D42□-□80-F XS5F-D421-□80-SA XS5W-D42□-□81-F XS5W-D421-□81-SA	
		NC	E2EW-(Q)X□B2□-M1TJ/M1 E2EQ-X□B2□-M1TJ/M1		
		NO+NC	E2EW-(Q)X□B3□-M1TJ/M1 E2EQ-X□B3□-M1TJ/M1		
		NO	E2EW-(Q)X□C1□-M1TJ/M1 E2EQ-X□C1□-M1TJ/M1		
	NPN	NC	E2EW-(Q)X□C2□-M1TJ/M1 E2EQ-X□C2□-M1TJ/M1		
		NO+NC	E2EW-(Q)X□C3□-M1TJ/M1 E2EQ-X□C3□-M1TJ/M1		

*1. If the XS5W Series Connector which has a socket and plug on the cable ends is connected to the Sensor, this part will be a plug.
Note: Different from Proximity Sensor wire colors.

XS5

Dimensions

(Unit: mm)

Socket and Plug on Cable Ends XS5W

Wiring Diagram for 4 Cores

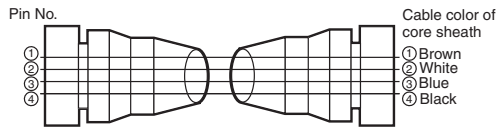

Sockets on One Cable End XS5F

Wiring Diagram for 4 Cores

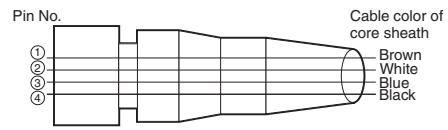

Straight (Socket)/straight (Plug)

XS5W-D421-□81-F/XS5W-D421-□81-SA

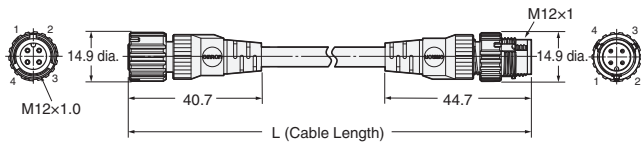

Straight type

XS5F-D421-□80-F/XS5F-D421-□80-SA

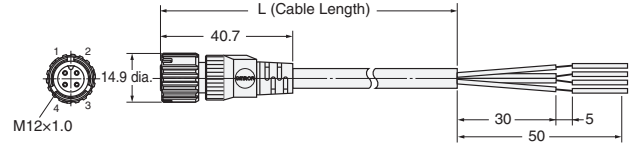

Right-angle (Socket)/right-angle (Plug)

XS5W-D422-□81-F

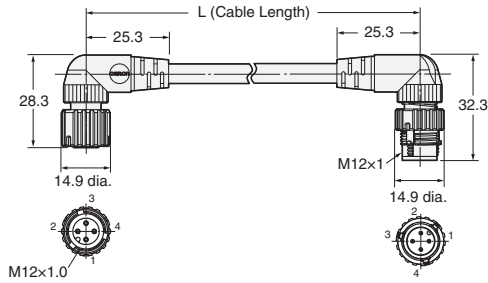

Right-angle type

XS5F-D422-□80-F

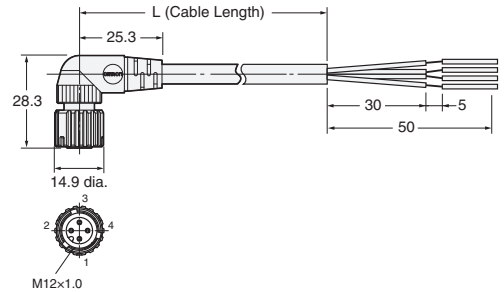

Straight (Socket)/right-angle (Plug)

XS5W-D423-□81-F

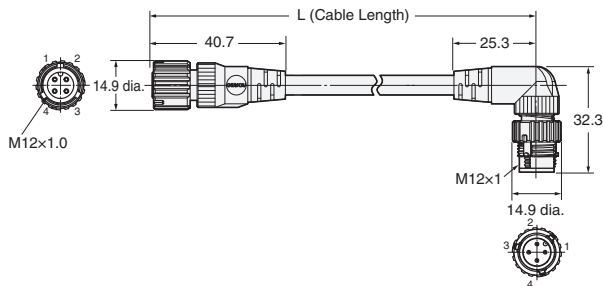

Right-angle (Socket)/straight (Plug)

XS5W-D424-□81-F

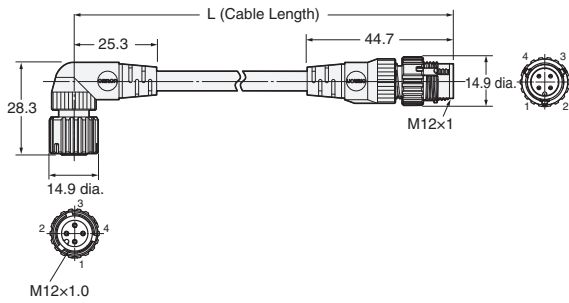

Terms and Conditions Agreement

Read and understand this catalog.

Please read and understand this catalog before purchasing the products. Please consult your OMRON representative if you have any questions or comments.

Warranties.

- (a) Exclusive Warranty. Omron's exclusive warranty is that the Products will be free from defects in materials and workmanship for a period of twelve months from the date of sale by Omron (or such other period expressed in writing by Omron). Omron disclaims all other warranties, express or implied.
- (b) Limitations. OMRON MAKES NO WARRANTY OR REPRESENTATION, EXPRESS OR IMPLIED, ABOUT NON-INFRINGEMENT, MERCHANTABILITY OR FITNESS FOR A PARTICULAR PURPOSE OF THE PRODUCTS. BUYER ACKNOWLEDGES THAT IT ALONE HAS DETERMINED THAT THE PRODUCTS WILL SUITABLY MEET THE REQUIREMENTS OF THEIR INTENDED USE.

Omron further disclaims all warranties and responsibility of any type for claims or expenses based on infringement by the Products or otherwise of any intellectual property right. (c) Buyer Remedy. Omron's sole obligation hereunder shall be, at Omron's election, to (i) replace (in the form originally shipped with Buyer responsible for labor charges for removal or replacement thereof) the non-complying Product, (ii) repair the non-complying Product, or (iii) repay or credit Buyer an amount equal to the purchase price of the non-complying Product; provided that in no event shall Omron be responsible for warranty, repair, indemnity or any other claims or expenses regarding the Products unless Omron's analysis confirms that the Products were properly handled, stored, installed and maintained and not subject to contamination, abuse, misuse or inappropriate modification. Return of any Products by Buyer must be approved in writing by Omron before shipment. Omron Companies shall not be liable for the suitability or unsuitability or the results from the use of Products in combination with any electrical or electronic components, circuits, system assemblies or any other materials or substances or environments. Any advice, recommendations or information given orally or in writing, are not to be construed as an amendment or addition to the above warranty.

See <http://www.omron.com/global/> or contact your Omron representative for published information.

Limitation on Liability; Etc.

OMRON COMPANIES SHALL NOT BE LIABLE FOR SPECIAL, INDIRECT, INCIDENTAL, OR CONSEQUENTIAL DAMAGES, LOSS OF PROFITS OR PRODUCTION OR COMMERCIAL LOSS IN ANY WAY CONNECTED WITH THE PRODUCTS, WHETHER SUCH CLAIM IS BASED IN CONTRACT, WARRANTY, NEGLIGENCE OR STRICT LIABILITY.

Further, in no event shall liability of Omron Companies exceed the individual price of the Product on which liability is asserted.

Suitability of Use.

Omron Companies shall not be responsible for conformity with any standards, codes or regulations which apply to the combination of the Product in the Buyer's application or use of the Product. At Buyer's request, Omron will provide applicable third party certification documents identifying ratings and limitations of use which apply to the Product. This information by itself is not sufficient for a complete determination of the suitability of the Product in combination with the end product, machine, system, or other application or use. Buyer shall be solely responsible for determining appropriateness of the particular Product with respect to Buyer's application, product or system. Buyer shall take application responsibility in all cases.

NEVER USE THE PRODUCT FOR AN APPLICATION INVOLVING SERIOUS RISK TO LIFE OR PROPERTY OR IN LARGE QUANTITIES WITHOUT ENSURING THAT THE SYSTEM AS A WHOLE HAS BEEN DESIGNED TO ADDRESS THE RISKS, AND THAT THE OMRON PRODUCT(S) IS PROPERLY RATED AND INSTALLED FOR THE INTENDED USE WITHIN THE OVERALL EQUIPMENT OR SYSTEM.

Programmable Products.

Omron Companies shall not be responsible for the user's programming of a programmable Product, or any consequence thereof.

Performance Data.

Data presented in Omron Company websites, catalogs and other materials is provided as a guide for the user in determining suitability and does not constitute a warranty. It may represent the result of Omron's test conditions, and the user must correlate it to actual application requirements. Actual performance is subject to the Omron's Warranty and Limitations of Liability.

Change in Specifications.

Product specifications and accessories may be changed at any time based on improvements and other reasons. It is our practice to change part numbers when published ratings or features are changed, or when significant construction changes are made. However, some specifications of the Product may be changed without any notice. When in doubt, special part numbers may be assigned to fix or establish key specifications for your application. Please consult with your Omron's representative at any time to confirm actual specifications of purchased Product.

Errors and Omissions.

Information presented by Omron Companies has been checked and is believed to be accurate; however, no responsibility is assumed for clerical, typographical or proofreading errors or omissions.

Related Products

Proximity Sensors E2E NEXT Series

- Exceptional sensing range*1. Approximately double the sensing distance of previous models
- High-brightness LED indicator visible from 360°
- Only 10 seconds*2 to replace a proximity sensor with the e-jig (mounting sleeve)
- Sensor cable with enhanced oil resistance to withstand oil for 2 years*3

*1. Based on Omron investigation in August 2022.

*2. Time required to adjust the distance when a sensor is installed. Based on Omron investigation.

*3. Refer to *Ratings and Specifications* in the catalog for details.

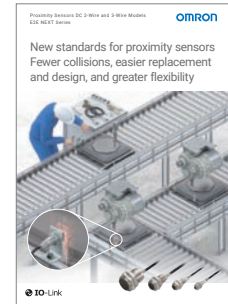

Refer to the catalog for details.

Cat. No. D120

Oil-resistant Proximity Sensors E2ER/E2ERZ

- Reduces failures caused by ingress of cutting oil and resists oil for 4 years*1
- Four years*1 of stable operation verified in oil resistance testing with representative cutting oils
- Fluoresin blocks ingress from cables
- State-of-the-art sealing methods block ingress through cable joints

*1. Years in actual usage environment in Omron's unique accelerated evaluation tests. Applicable oil type: specified in JIS K 2241:2000

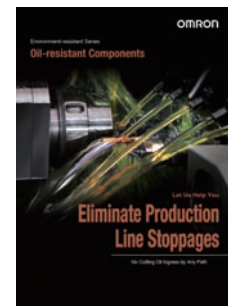

Refer to the catalog for details.

Cat. No. Y215

Smartclick is a registered trademark of OMRON Corporation.

Company names and product names in this document are the trademarks or registered trademarks of their respective companies.

The product photographs and figures that are used in this catalog may vary somewhat from the actual products.

Note: Do not use this document to operate the Unit.

OMRON Corporation Industrial Automation Company

Kyoto, JAPAN

Contact : www.ia.omron.com

Regional Headquarters

OMRON EUROPE B.V.

Wegalaan 67-69, 2132 JD Hoofddorp
The Netherlands
Tel: (31) 2356-81-300 Fax: (31) 2356-81-388

OMRON ELECTRONICS LLC

2895 Greenspoint Parkway, Suite 200
Hoffman Estates, IL 60169 U.S.A.
Tel: (1) 847-843-7900 Fax: (1) 847-843-7787

OMRON ASIA PACIFIC PTE. LTD.

438B Alexandra Road, #08-01/02 Alexandra
Technopark, Singapore 119968
Tel: (65) 6835-3011 Fax: (65) 6835-3011

OMRON (CHINA) CO., LTD.

Room 2211, Bank of China Tower,
200 Yin Cheng Zhong Road,
PuDong New Area, Shanghai, 200120, China
Tel: (86) 21-6023-0333 Fax: (86) 21-5037-2388

Authorized Distributor:

©OMRON Corporation 2021-2024 All Rights Reserved.
In the interest of product improvement,
specifications are subject to change without notice.

CSM_5_4

Cat. No. D125-E1-08 0124 (0921)